

ABB SOLAR INVERTERS

# **PVS-100/120 medium voltage station**

## Hardware manual

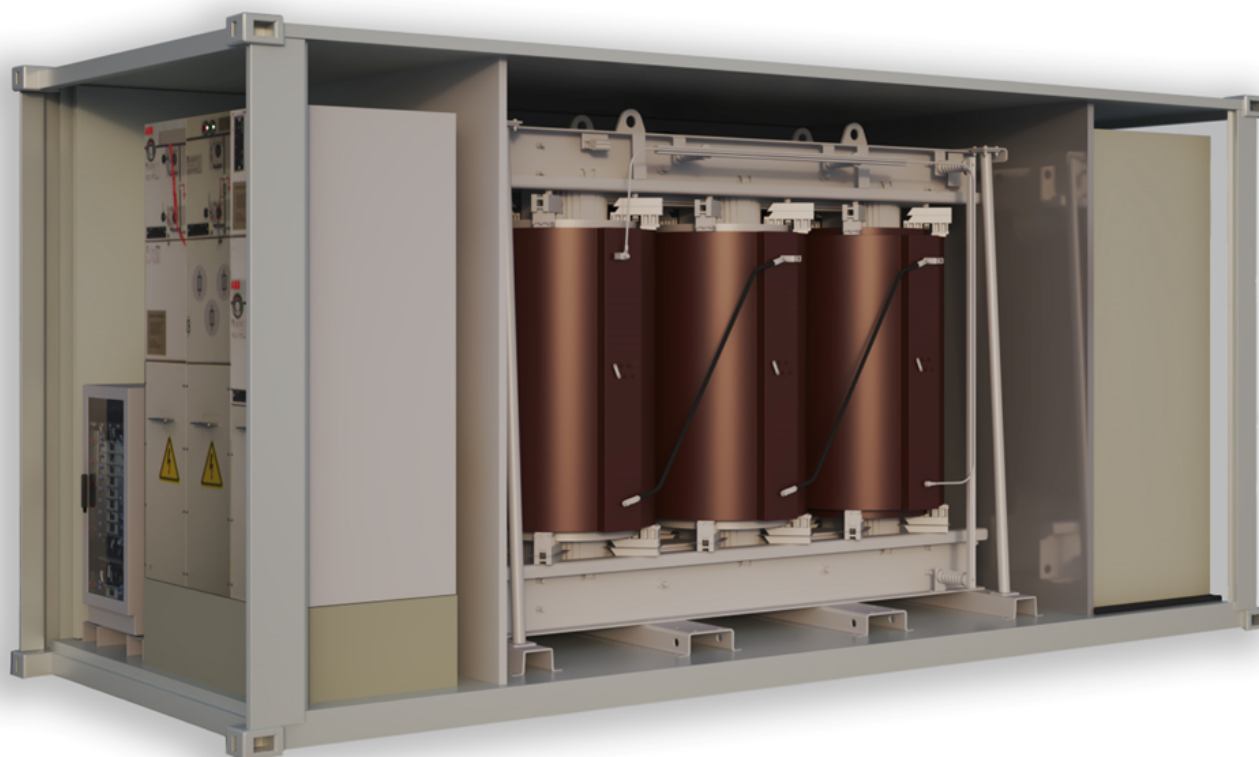



# PVS-100/120 medium voltage station

Hardware manual

Table of contents



1. Safety instructions



5. Electrical installation



7. Start-up and operation





# Table of contents

---

## 1 Safety instructions

Contents of this chapter .....	9
Use of warnings .....	9
Allowed usage .....	10
Safe installation, start-up and maintenance .....	10
General safety instructions .....	10
MVS working area safety .....	11
Personal protective equipment (PPE) .....	11
Safety instructions for MV switchgear and MV transformer area .....	11
Safety instructions for the auxiliary services board .....	12
Safe operation .....	13

## 2 Hardware description

Contents of this chapter .....	15
Product overview .....	15
External dimensions .....	15
Layout drawing .....	16
Working areas and main components .....	16
Main components .....	17
AC cabinet components .....	18
Inverter inputs .....	18
Auxiliary service board .....	19
MV switchgear .....	20
MV switchgear circuit .....	20
MV transformer .....	21
String inverter .....	22
Main circuit diagram .....	22
Type designation label .....	23
Type designation key .....	24
MVS optional codes .....	24

## 3 Storing, lifting and transporting

Contents of this chapter .....	27
Storing .....	28
Conditions for using desiccant bags .....	28
Lifting .....	29
Tools used for lifting .....	29
Lifting instructions .....	30
Transporting .....	30
Incoming inspection at arrival .....	31

## 4 Mechanical installation

Contents of this chapter .....	33
Safety .....	33
Tools .....	33

---



Foundation guidelines .....	33
Placing the MVS on the foundation .....	34
Fastening the MVS .....	35
Constructing earthing electrode and earthing .....	35
Filling the pit and finalizing the surroundings .....	36
Adding weather protection hoods .....	37
Tools .....	37
Procedure .....	38
<b>5 Electrical installation</b>	
Contents of this chapter .....	41
Routing the cables .....	42
Earthing .....	42
Protective earthing (grounding) inside the MVS .....	43
Measuring the insulation resistance of the cabling .....	43
Connecting the inverter inputs .....	44
Connecting the communication and auxiliary cabling (Optional) .....	46
Connecting the power grid cabling to the MV switchgear .....	46
<b>6 Finalizing the installation</b>	
Contents of this chapter .....	49
Finalizing the installation .....	49
Landscaping the station .....	50
Checking the installation of MVS .....	50
<b>7 Start-up and operation</b>	
Contents of this chapter .....	51
Tools needed .....	51
Prerequisite .....	51
Start-up procedure .....	52
<b>8 Maintenance</b>	
Contents of this chapter .....	55
Tools list .....	55
Tightening torque .....	56
Maintenance intervals .....	57
Maintenance activities .....	57
Maintenance intervals .....	58
Cleaning procedure .....	58
Replacing component .....	60
Maintenance of painted surfaces .....	62
Repainting the scratched areas .....	62
Tools and materials .....	62
Painting the damaged surface (no visible rust) .....	62
Painting the damaged surface (visible rust) .....	62
Maintenance of Zinc coated surfaces .....	63
Maintenance of grounding bars and points .....	63
Tools .....	63
Procedure .....	63
Maintaining external hinges and locks .....	63
Tools .....	63



Procedure .....	63
Replacing the door limit switch .....	64

## **9 Technical data**

Contents of this chapter .....	65
Technical data and types: PVS-100 MVS .....	66
Technical data and types: PVS-120 MVCS .....	68

## **10 Drawings**

Contents of this chapter .....	71
List of technical drawings .....	71

*Further information*







# 1

## Safety instructions

---

### Contents of this chapter

This chapter presents the use of warnings in the manual and gives instructions for safe installation, start-up, use and maintenance of the PVS-100/120 medium voltage station (MVS).

### Use of warnings

Warnings caution you about conditions which can result in serious injury or death and/or damage to the equipment, and advise on how to avoid the danger. The following warning symbols are used in this manual:

**WARNING!**

Electricity warning warns of hazards from electricity which can cause physical injury and/or damage to the equipment.

---

**WARNING!**

General warning warns about conditions, other than those caused by electricity which can result in physical injury and/or damage to the equipment.

---

**WARNING!**

General warning warns about weather conditions, prohibited maintenance operations during a typhoon, thunderstorm, snow, rain and electrical storm. Maintenance in such conditions can result in physical injury and/or damage to the equipment.

---



**WARNING!**

General warning warns about maintenance work on the roof which should always be done from the outer perimeter, considering the local safety regulations.

---

## Allowed usage

- The PVS-100/120 medium voltage station (MVS) is designed to transform AC current from a group of inverters and finally feed to a medium voltage grid. Use the MVS only at its permissible input/output ratings and ambient conditions. Make sure this compliance is satisfied before commissioning.
- The operation and maintenance of the MVS must be carried out by certified technicians that fulfill all local skill set and safety requirements. Any unqualified personnel must maintain a safe distance from the MVS. All activities must be in accordance with the criteria described in the ABB technical documents and local regulations.
- Make changes to the MVS only with the direct authorization of ABB. Any alterations done outside ABB approval will invalidate the warranty for the product. ABB is not liable for any damages caused by these changes.
- The MVS is a non-walk-in type station, designed to be operated from the outside. Make sure the side doors are closed at all times during operation and that no personnel is inside or in the near vicinity of the MVS.



## Safe installation, start-up and maintenance

This section contains the safety instructions which you must follow when installing, commissioning and maintaining the MVS. If ignored, physical injury or death may follow, or damage may occur to the equipment.

- Only authorized electricians are allowed to install, start-up and maintain the MVS. Working methods, tools, components etc. must follow the IEC regulations.
- Obey all local safety regulations concerning electrical stations.
- The MVS should be energized and de-energized only by an authorized person who has the task-specific instructions for the operation of an MV substation and permission from the on-site foreperson in charge of electrical work.
- If other people must be in the vicinity while the door is open, warn them, and if required, provide supervision and guidance.

### ■ General safety instructions

---



**WARNING!**

Before you perform any work in the MVS, obey the following safety precautions.

---

1. Clearly identify the work location.
  2. Read the safety instructions of the work area and the component you are working on. See the subsections below and the component-specific manuals.
  3. Disconnect and secure against reconnection.
  4. Disconnect all possible power supplies (external, auxiliary and inverters) and open all base fuse switches. Lock the disconnectors in the open position and attach a warning notice to them. After disconnecting power to the inverters, always wait until the stored energy of the inverters is discharged. See also, inverters manual.
  5. Use protection against any live parts.
-

6. Take special precautions when you work close to exposed conductors.
7. Measure to ensure that there is no voltage connected.
8. Carry out earthing (grounding) and short circuiting.
9. Issue a permit to work.

### ■ MVS working area safety

The MVS has three working areas:

- AC Cabinet Area
- MV Transformer Area
- MV Switchgear Area
- Free Area

Each work area has separate safety instructions.

### Personal protective equipment (PPE)

- Perform any operation on the equipment with suitable work clothes and instruments.
- When choosing a personnel protective equipment, consider environmental conditions such as humidity, noise, etc. and local regulations.
- Make sure the work clothes and accessories are not prone to generate electrostatic charges, fires or any other condition that compromises personnel safety.
- The minimum required safety equipment is as follows:
  - Safety shoes
  - Safety gloves
  - Safety glasses
  - Head protection
  - Hearing protection
  - Work clothes



### Safety instructions for MV switchgear and MV transformer area



#### **WARNING!**

Perform the below instructions before you start working inside the MV switchgear and/or MV transformer area. Ignoring the instructions can cause physical injury or death, or damage to the equipment.

1. Identify the MV switchgear and read its safety instructions.
2. Check the operation of the capacitive voltage indicators in all MV switchgear bays (all phase LEDs are switched on when a voltage is connected).
3. Disconnect the MV switchgear from all possible power supplies (external, auxiliary, and inverters as well as any parallel connection stations), and secure by locking and tagging.
  - a. Stop the string inverters outside the MVS. Open the DC disconnecting switches in each inverter unit and add warning notices. If applicable, open the AC disconnecting switches in each inverter unit, lock and add warning notices.
  - b. Open all fuse base switches of the inverter inputs, lock and add warning notices.
  - c. Open all auxiliary breakers, switches and fuses in the auxiliary service board, lock and add warning notices.
  - d. Turn the vacuum circuit breaker of the MV switchgear to open position. Lock and add warning notice.

## 12 Safety instructions

- e. Turn the disconnecting switch of the MV transformer side of the MV switchgear to open position. Lock and add a warning notice.
  - f. Disconnect the MV switchgear from the MV network (all possible external power supplies, grid and parallel stations). See the User's manual of the MV switchgear. Lock and add warning notices.
4. Check that all shrouds/screens are in place.
  5. Check that you are not near to any live parts while working. All live circuits must be protected with shrouds/screens.
  6. Make sure that the MV switchgear is dead.
    - Check the status of voltage indicators in all MV switchgear bays. Note that all phase LEDs which were switched on AC cabinet at step 3 are now switched off).
  7. Earth the MV switchgear and AC cabinet.
    - Turn the earthing switches of the MV switchgear to “earthed” position, lock (remove the MV switchgear Ronnis key of the V module) and add warning notices. If the station is connected to parallel stations, make sure that you also turn the appropriate earthing switches of the parallel stations to “earthed” position.
    - Temporarily, ground the MV switchgear terminals at all possible external power supplies (grid and parallel stations). See the User's manual of the MV switchgear. Lock and add warning notices.
    - Ground the inverter AC sides with appropriate temporary grounding set.
  8. Check that the MV transformer is dead (high voltage terminals, low voltage terminals, any auxiliary power, and instrumentation). Use an appropriate high voltage tester only for the high voltage side, and a voltage detector with suitable testing heads for the low voltage side.
  9. Issue a work permit.



### **Safety instructions for the auxiliary services board**

1. Open the main circuit breaker or main switch of the auxiliary service transformer, and secure by locking and tagging.
  2. Open the secondary circuit breaker of the auxiliary service transformer, and secure by locking and tagging.
  3. Open all switches, breakers and connectors of the auxiliary service board, and secure by locking and tagging.
  4. Make sure you are not near to any live parts while working. Disconnect the live circuits or protect them with shrouds/screens.
  5. Check the status of the voltage indicators in the auxiliary service board.
  6. Check that the auxiliary service board is dead.
  7. Issue a work permit.
-

## Safe operation

This section contains the safety instructions which you must follow when operating the MVS. If ignored, physical injury or death, or damage may occur.



**WARNING!**

Obey these instructions to prevent injury, death, or damage to the equipment

---



**WARNING!**

Keep all doors locked while the MVS is operating. Allow access to only authorized personnel.

---

1. Keep all doors of the MVS closed during operation. Give the keys only to authorized personnel.
2. Before you start a group of inverters, check the connections of each inverter input, and the recommendations in the specific inverter manual.
3. Do not open the AC base fuse switches when the MVS is operating.
4. Before you adjust the group of inverters and set them into service, make sure that all of them are suitable for operation.
5. Do not use the inverters in a manner not specified in the manual.

**Note:**

- Spend as little time as possible near the inverters or the MVS.
- Use a personal computer with a communication cable of sufficient length when you monitor or adjust inverter parameters during operation.





2

## Hardware description

---

### Contents of this chapter

This chapter provides an overview of the PVS-100/120 medium voltage station (MVS). It also includes layout, type designation label and type designation information.

### Product overview

The PVS-100/120 medium voltage station connects a group of inverters to a medium voltage power grid. This solution is constructed around a skid house that contains:

- **MV transformer**—transforms low voltage from inverters to medium voltage for the power grid.
- **Auxiliary service transformer**—supplies power to the AC cabinet and auxiliary components of the MVS.
- **MV switchgear**—connects to the power grid. It is also the main protecting, switching, breaking and disconnecting equipment of the medium-voltage side of the solar power plant.
- **AC cabinet**—contains all parallel connections to the inverter inputs and the auxiliary service boards (required for the autonomous function of the MVS). Note that the AC cabinet also includes an additional space for customer use (e.g. communication board, etc.).
- **Free area**—for optional customer communication board and UPS.

### External dimensions

The MVS is constructed over a skid suitable for transportation inside a 20 HC container with,

- External dimension (length, width, height) = 6060 x 2450 x 2900 mm
  - Total weight = 11 ton
-

## Layout drawing

This section describes the working areas and main components of the MVS. For more information, see drawing, 3AES-PVS-100\_120\_MVS-30-DW01.

## Working areas and main components

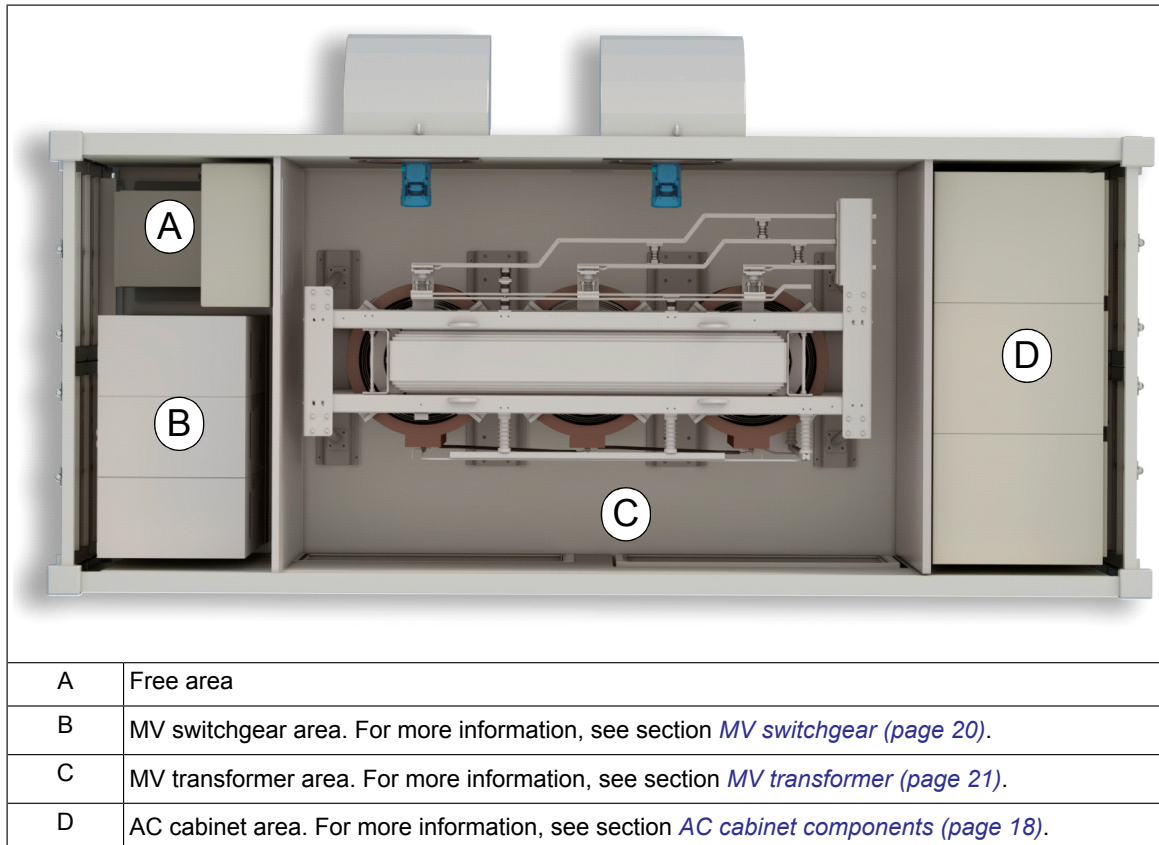



■ Main components

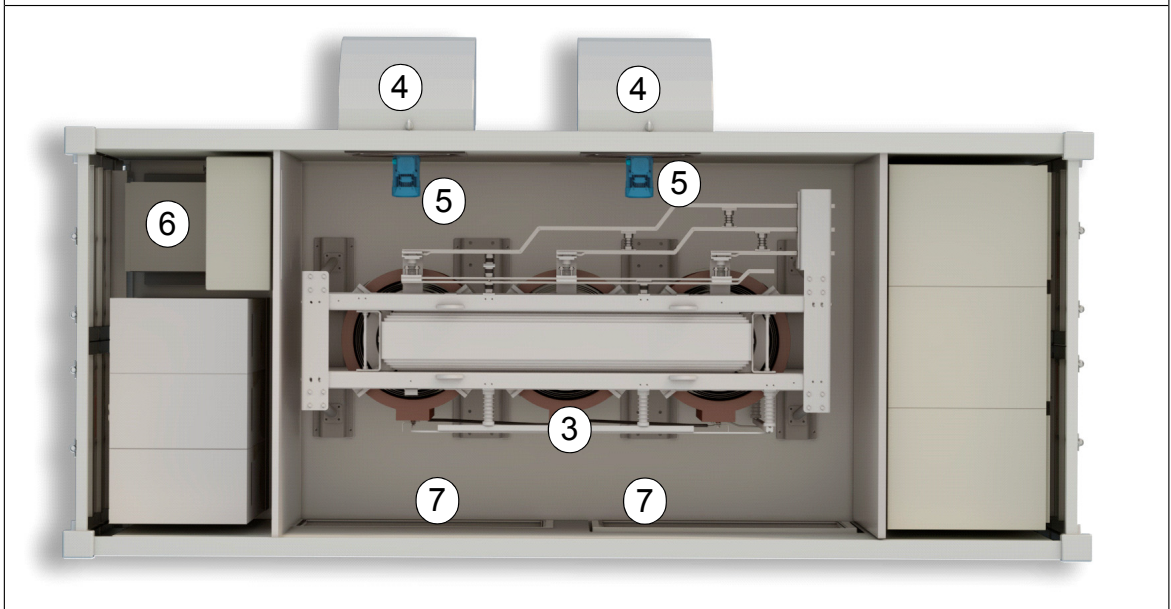
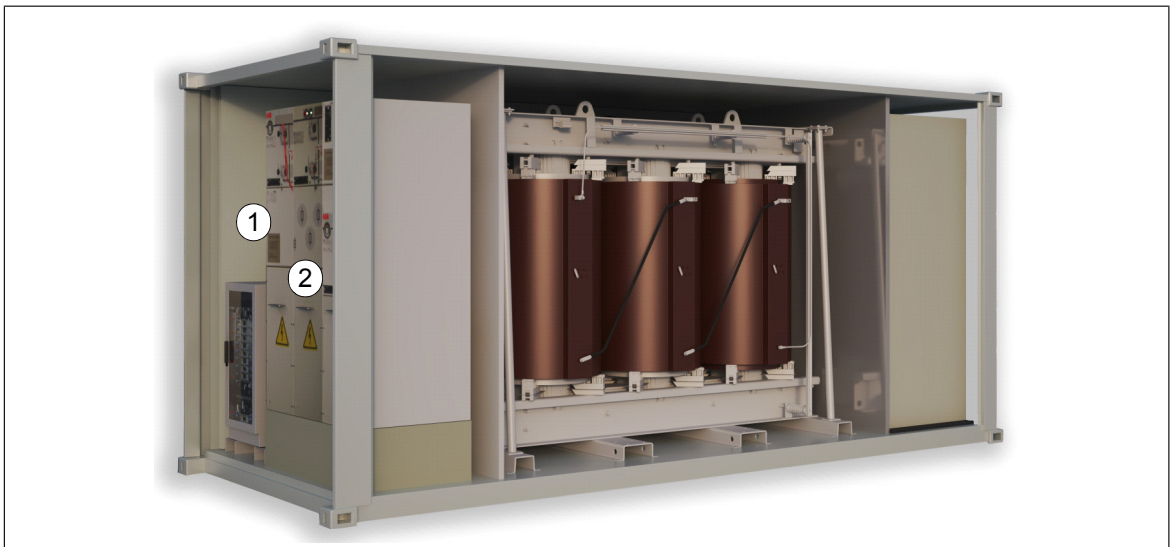

A	1	Free area
B	2	MV switch gear
C	3	MV transformer
	4	Exhaust air hood
	5	Fans
	6	Auxiliary service transformer
	7	Inlet air grid

■ AC cabinet components

The diagram shows two views of an AC cabinet: the front side and the back side. The front side (left) features three vertical compartments. The top row has three smaller compartments, with the rightmost one labeled '8'. The bottom row has three larger compartments, with the leftmost one labeled '9'. The back side (right) features three vertical compartments. The top row has three smaller compartments: the leftmost is labeled '10' and contains three vertical bars; the middle and rightmost are labeled '11' and contain multiple rows of horizontal slots. The bottom row has three larger compartments, with the leftmost one labeled '12'.

		<b>AC cabinet panel front side</b>	<b>AC cabinet panel back side</b>
D	8	Auxiliary service board. For more information, see section <a href="#">Auxiliary service board (page 19)</a> .	
	9	Inverter inputs. For more information, see section <a href="#">Inverter inputs (page 18)</a> .	
	10	Bus bar output compartment	
	11	Main input circuit surge arrester and auxiliary transformer primary feeder protection location	
	12	Removable back side access panels	

■ Inverter inputs

Inverter inputs	PVS-100-MVCS-...	PVS-120-MVCS-...
8	800	960
10	1000	1200
12	1200	1440
14	1400	1680
16	1600	1920
18	1800	2160
20	2000	2400
22	2200	2640
24	2400	2880
26	2600	3120

## ■ Auxiliary service board

The figure below describes the components of a standard auxiliary service board. Additional components and customization is included in the project specific documentation.

See also, UPS connection drawing 3AES-PVS-100/120\_MVS-14-SP01.

### Note:

Technical drawings are delivered with the unit, only if you requested.

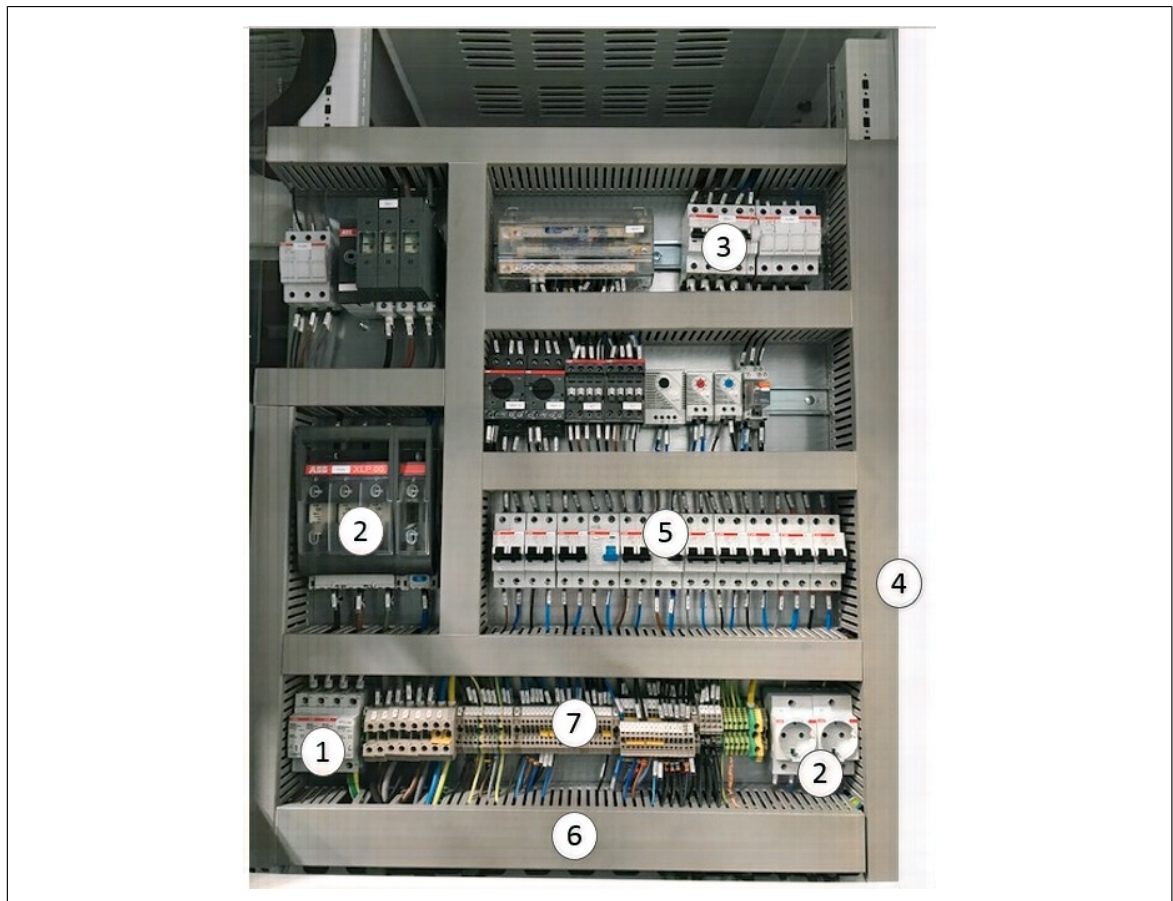

1	Surge arrester protection for the auxiliary service board
2	Upstream on-load fuse switch for auxiliary service transformer protection
3	Downstream circuit breaker for auxiliary service transformer protection
4	Torch light and charger
5	Auxiliary service board circuit breakers and differential protections
6	Grounding busbar
7	Terminals block
8	Schuko sockets

## ■ MV switchgear

The MVS is always equipped with outdoor MV switchgear. Type CV is used as the standard and consists of two modules:

- C uses a double cable bushing configuration to connect to:
  1. The grid-side module with grid cable terminals and a disconnecting and earthing switch. See figure below.

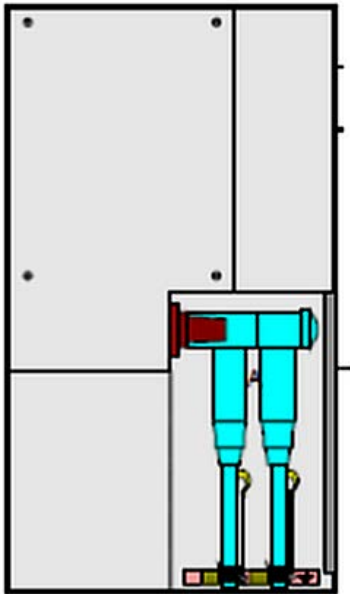

2. The connection of other parallel-connected substations.

- V is the Vacuum circuit breaker module equipped with the Self power relay (REJ 603) as a standard.

### **MV switchgear circuit**

The diagrams below show the standard CV MV switchgear and optional CCV MV switchgear. Both the switchgears can be upgraded to V-module motorized and REF615 protection relay by adding combisensors for metering purpose.

---

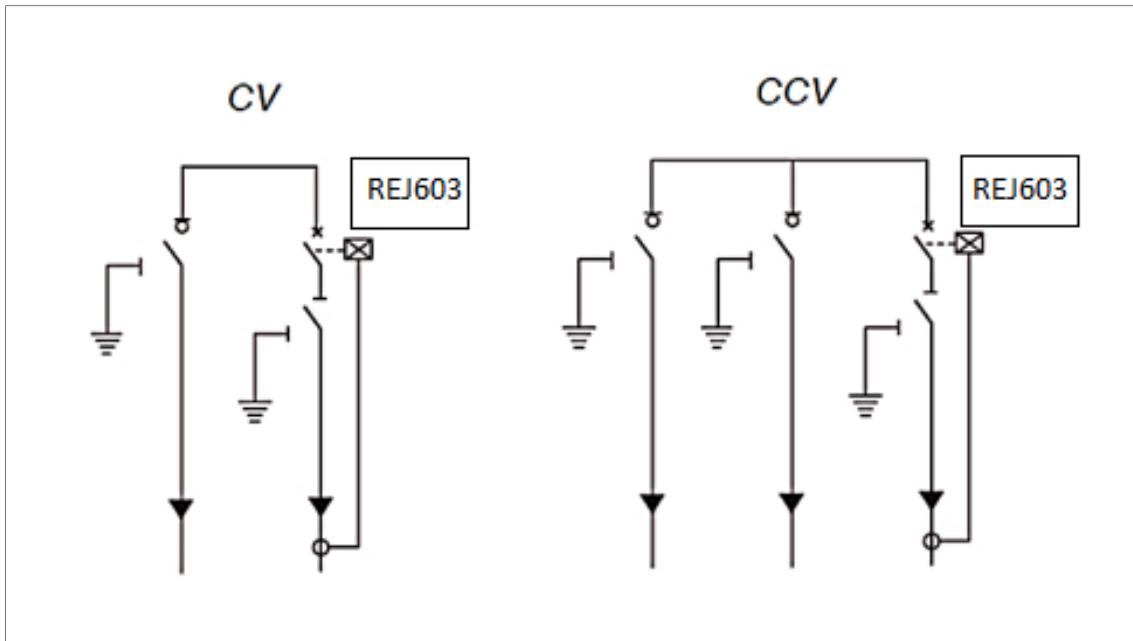

For more information, see MV switchgear manuals ([1YVA000024](#) and [1YVA000026](#))

■ **MV transformer**

See MV transformer manual. For dry-type MV transformer, see Operation and maintenance manual (1LES10000-YB).

## ■ String inverter

For information on the inverters, see:

- String inverter- Product Manual Appendix ([9AKK10103A3456](#))

## Main circuit diagram

The general single-line diagram depends on the configuration and options of the unit as well as the configuration of the inverter group. The table below describes the baseline configurations.

See also, single line diagram 3AES-PVS-100/120\_MVS-01-DW01.

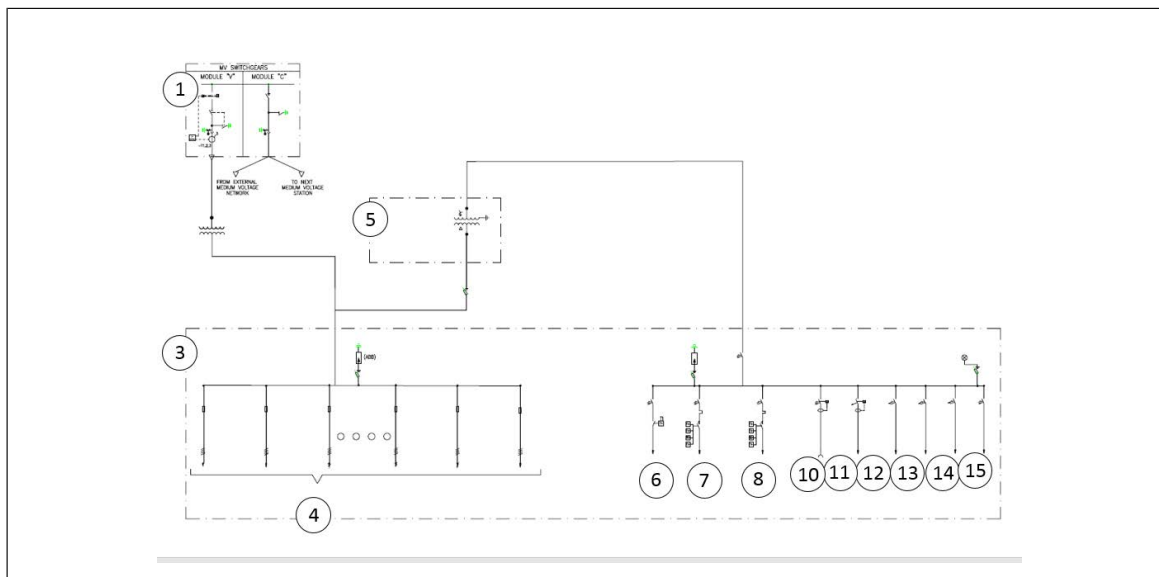

1	CV MV switchgear (possible to upgrade to CCV)
2	MV transformer
3	AC cabinet
4	Inverter inputs. See also, section <a href="#">Inverter inputs (page 18)</a> .
5	Auxiliary service transformer
<b>Auxiliary service board</b>	
6	AC cabinet heating
7	MV Transformers external fan 1
8	MV transformers external fan 2
9	External power socket
10	Lighting
11	Optional communication cabinet power supply
12	MVS control equipment
13	AC cabinet power supply
14	Spare

## Type designation label

The figure below shows an example of the type designation label. The label contains the basic data of the unit. It is located on the access door to the MV transformer.

**S/N:**  
NNNNNNNNNNNN (A)

**Description:** (B)  
Medium Voltage Station

**Type Designation:** (C)  
PVS-100/120 - MVS - XXXX- Y +options  

(D)
(E)
(F)
(G)
(H)

**MADE IN SPAIN** (I)  
**MANUFACTURED IN 20XX** (J)



A	Serial number. Each unit has a unique serial number
B	Description of the unit: Medium Voltage Compact Skid
C	Type designation key. For more information, see <a href="#">Type designation key (page 24)</a> .
I	Manufacturing country name
J	Manufacturing year

## Type designation key

The type designation describes the composition of the unit. The type designation is visible on the type designation label which is attached to the unit. The complete type designation is divided into sub codes:

- The first 1...18 digits form the basic code which describes the basic construction of the unit. The fields in the basic code are separated by hyphens.
- The option codes follow the basic code. Each option code starts with an identifying letter (common for the whole product series), followed by descriptive digits. The option codes are separated by plus signs.

The following table describes the fields of the basic code and the option code. Refer to the items of figure in [Type designation label](#).

Item	Description
E	MVS = Station type
F	Power rating XXXXkVA See chapter <a href="#">Technical data (page 65)</a> .
G	LV voltage -Y = 480 V -Y = 400 V
H	Option (plus) codes for additional upgrades

### ■ MVS optional codes

Code	Name	Description
MV dry transformer		
+TRECO	Dry transformer ECO losses	Standard losses dry transformer is replaced with eco losses dry transformer
+TR36kV	Dry transformer 36kV	Standard losses dry transformer 22kV is replaced with dry transformer 33kV
+TR50Hz	Dry transformer 50Hz	Standard losses dry transformer 60 Hz is replaced with dry transformer 50 Hz
Auxiliary service board		
+ATR20	Auxiliary transformer power rating	Standard 10 KVA auxiliary service transformer is upgraded to a 20 KVA 400/230 V auxiliary service transformer
+ATR30	Auxiliary transformer power rating	Standard 10 KVA auxiliary service transformer is upgraded to a 30 KVA 400/230 V auxiliary service transformer
+ATR3	Additional mono-phase auxiliary transformer power rating	An additional auxiliary monophas auxiliary service transformer of 3kVA is installed to provide customer with specified voltage level and frequency
+SPD412	AC standard surge protection device Type I + II 800 V	Standard surge protection device Type II is replaced with standard surge protection device Type I + II. Only applicable for PVS-175 stations
+SPD412	AC standard surge protection device Type I + II 400 V	Standard surge protection device Type II is replaced with standard surge protection device type I + II. Only applicable for PVS-100/120 stations



Code	Name	Description
+MCB	Main circuit breaker	Addition of a main circuit breaker
<b>Station</b>		
+C5M	C5-M corrosion protection degree for enclosure	Enclosure and MV transformer standard C4 corrosion protection degree is upgraded to C5M corrosion protection degree. Also, select the upgrade of C5 protection for the dry transformer (+ TRC5). This optional is recommended for sites near sea (>10 km)
+SIGC	Signal concentration	Concentration of all the signals of the station in one point
+COM1	Basic communication board 1	Communication board for projects of 1 station
+COM2	Basic communication board 2	Communication board for projects of >1 station, for communication between stations
+UPS3	UPS power value 3kVA	UPS with capacity of 3kVA (6min) / 2kVA (8min) /1kVA (20min) /0,5kVA (48min) /0,3kVA (95min). Installation included
+UPS6	UPS power value 6kVA	UPS with capacity of 6kVA (10min) / 4kVA (17min) /3kVA (23min) /2kVA (42min) /1kVA (84min). Installation included
+UPS10	UPS power value 10kVA	UPS with capacity of 10kVA (6min) / 8kVA (8min). Installation included
+COLOR	Non IEC cable colors	IEC standard cable colors are replaced with cables with customized colors
<b>Tests</b>		
+JP HR test	Japan MV transformer heat run test	JP transformer heat run test (one per transformer)
+JP SC calc	Japan MV transformer short circuit calculation	JP Transformer short circuit calculation (one per transformer)



# 3

## Storing, lifting and transporting

---

### Contents of this chapter

This chapter provides instructions for storing, lifting and transporting the PVS-100/120 medium voltage station (MVS).

---



**WARNING!**

Inspect carefully the container before performing any activity. Verify that the MVS has no protuberance, lack of rings, or any general poor condition.

---



**WARNING!**

Ignoring the following instructions can cause physical injury or death, or damage to the equipment:

- Use only authorized lifting equipment and personnel.
  - Prevent anybody getting under the load.
  - Do not stand on the roof while fastening the lifting slings or while lifting.
  - Do not throw slings or hooks onto the roof.
- 



**WARNING!**

Use original silica gel bags only during transport. Install new silica gel bags for storage.

---

## Storing

---



### WARNING!

To prevent damage to the MVS, keep the delivery packaging and protection canvas on until you install it.

---

- Always store the MVS in upright position.
- Avoid opening the doors unnecessarily and remove the transportation plates during storage and at the time of installation.
- If removing the MVS from protective packaging and if condensation is possible in the storage area, follow the below conditions:
  - Supply power to the internal heaters to maintain the inside temperature of the unit more than the outside temperature.
  - If power supply is not available, add humidity desiccant bags inside the station.
  - If the MVS is stored for more than two weeks without using electric heaters, use desiccant bags. See also, [Conditions for using desiccant bags \(page 28\)](#).
- Make sure the ground underneath the MVS is solid, flat, dry and vegetation-free. The ground must support the station evenly from below and there should not be any twisting or stress. Do not place the MVS directly onto the bare ground because this could damage the paint and cause corrosion.
- Place the MVS on wooden support beams. Locate the beams under the four corners and the middle points.

### ■ Conditions for using desiccant bags

- Hang the desiccant bags approximately 1 m from the floor.
- Use 500 grams of desiccant per week. For example, for four weeks of storage, use 2 kg of desiccant bags.
- Replace the bags with fresh bags every four weeks.
- Do not open the doors unnecessarily during the storage period.
- Examples of suitable container desiccants: Xdry desiccants “H model” or Clariant “Container Dri@II- Pole”.

**Note:** The MVS is delivered with desiccant bags from factory as standard.

The below figure shows the locations of desiccant bags, marked in red.

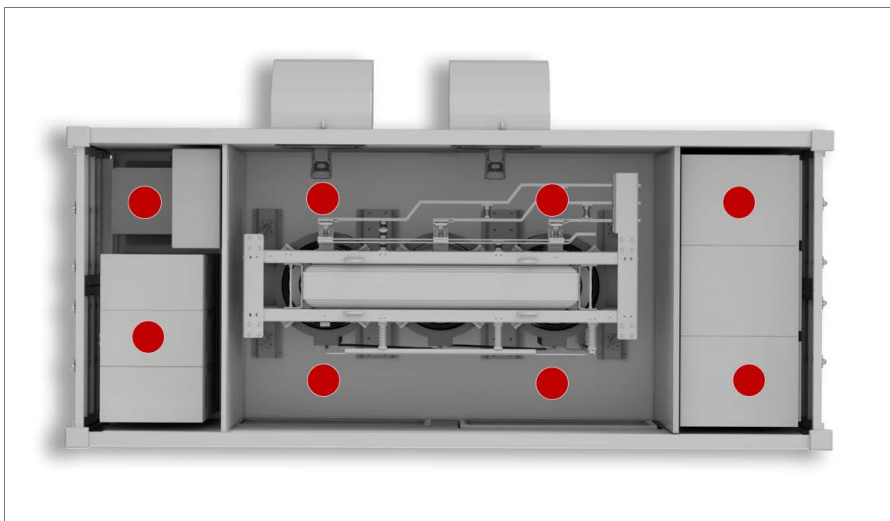

## Lifting

---



### **WARNING!**

Inspect the container before any activity. Make sure that the container has no protuberance, enough rings and is in good condition. Ignorance of this message can cause physical injury, death or damage to the equipment.

---

Before lifting the MVS, follow these instructions.

- Protect the corners of the MVS against shock.
- The minimum rated loading capacity of each sling is ten tons
- The minimum length of each sling is five meters.
- Adjust the length of lifting slings so that the MVS does not tilt during lifting.
- Do not allow the lifting slings to scratch the walls or roof. Damaged paint can lead to corrosion.
- Use a guide wire attached to a lower corner of the MVS to prevent rotation.
- Do not throw slings or hooks onto the roof.
- Do not stand on the roof during fastening the lifting slings or lifting.
- Before loading, make sure that nobody is present under the load.

### ■ **Tools used for lifting**

- 20 tons bridge crane or 70 tons truck crane
  - four slings
  - Forklift
-

## ■ Lifting instructions

1. To lift the station from the top, install the sling vertically and attach it to the upper corner castings. See the locations marked in below figure

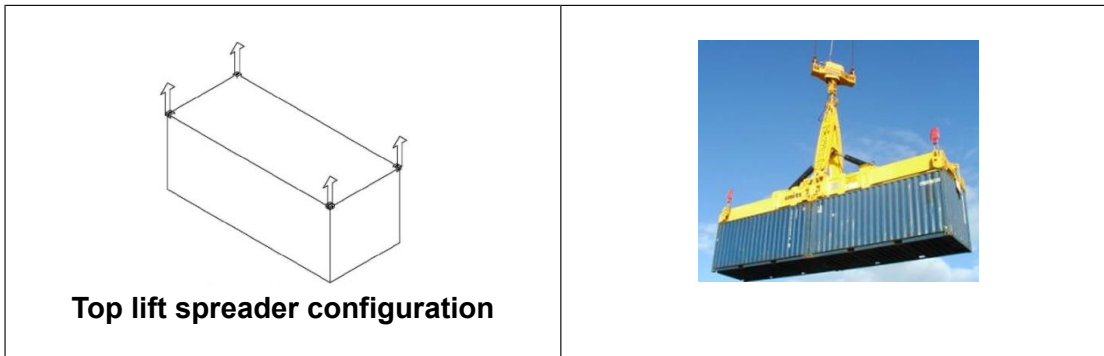

2. To lift the station from bottom, attach the slings from the bottom corner castings to a spreader bar.  
The angle between the slings and the bottom horizontal edge of the station should be 30 degrees and the spreader bar must be a minimum of 500 mm away from the top of the container. See below figure.

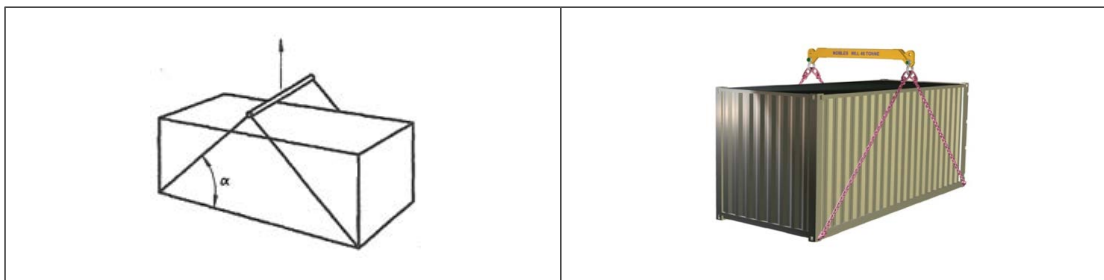

## Transporting



### **WARNING!**

Keep the transportation height as low as possible. Make sure the total height of the transportation is not more than the maximum allowed height.



### **WARNING!**

Transport the MVS on an open heavy-duty chassis. Do not use an enclosed trailer because the stations surface could easily be damaged.



### **WARNING!**

Do not throw the hooks over the roof. This can damage the paint and cause corrosion or operation problems.

Obey the following instructions:

- Protect the MVS with wooden corners, plastic film, etc. The MVS is delivered unpacked from the factory as standard.
- Protect the interior of the MVS from rainwater by using temporary protection plates (anti-typhoon) on air intakes and outlets.

- The MVS is built to fit inside an ISO 20 HC (1AAA according to ISO 3874) type shipping container. It can be transported on a dedicated sea container trailer using the standard container attachment system.
- If you are not using a dedicated sea container trailer, lay the MVS directly on the transportation chassis to prevent sliding and to keep the total height to the minimum possible level. Use friction enhancement mats (rubber) below the MVS. The maximum thickness of the mat should not be greater than three cm.
- For maritime/sea transportation, the maximum values considered are:
  - Stacking load - 96.000 kg
  - Racking load - 75 kN
  - Tare weight - 3100 kg
  - Gross weight - 19.000 kg.
- Fasten the MVS firmly onto the chasis using heavy duty straps.

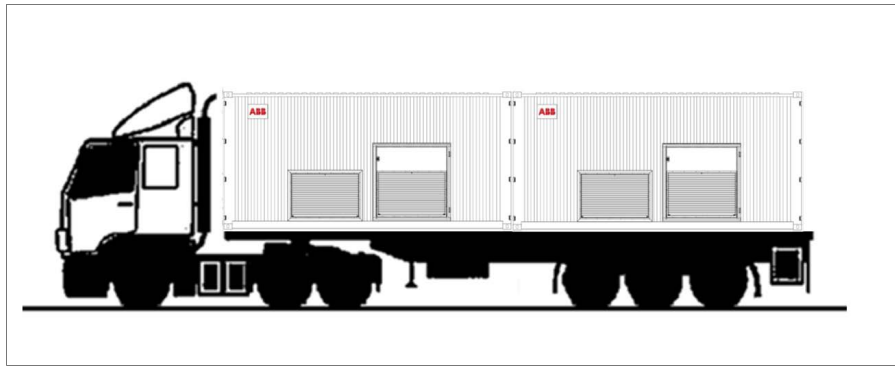

#### ■ Incoming inspection at arrival

- Visually check for any potential transportation damage(s). If any damages found, mark and record them and immediately inform your local ABB representative or your ABB sales contact.
  - Repair any damaged paint. See section, [Maintenance of painted surfaces \(page 62\)](#).
  - Check that the MVS corresponds to the delivery list and order. Record the deviations (if any) and immediately inform your local ABB representative or ABB sales contact.
-

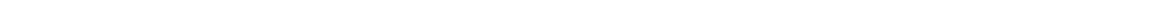



# 4

## Mechanical installation

---

### Contents of this chapter

This chapter describes the mechanical installation of the PVS-100/120 medium voltage station (MVS) and gives instructions on how to select the location and guidelines to build the foundation for the MVS. Always obey the local regulations.

### Safety

See [Safety instructions \(page 9\)](#).

Before you move the MVS, see instructions in chapter [Storing, lifting and transporting \(page 27\)](#).

### Tools

Use the following tools to move the MVS, to fasten the MVS foundation, and to tighten the connections:

- Crane, forklift, or pallet truck (with sufficient load capacity)
- Pozidriv and Torx (2.5 to 6 mm) screwdrivers with short and long heads or bits
- Torque wrench
- Set of wrenches and sockets.

### Foundation guidelines

For information on the MVS dimensions and footprint, see drawing 3AES-PVS-100\_120-MVS-30-DW02.

Always follow the local rules and laws when designing and constructing the foundation. Pay attention to the proper planning and constructing of the foundation. For example, an improper foundation can cause settling of the MVS or difficulty opening the door.

---

Follow the below guidelines:

- To prevent any risk of corrosion, install the MVS higher than its surroundings so that surface water will not collect around its perimeter.
- Tilt the surface of the surrounding ground at least 50 mm per meter (two inches per 40 in). This ensures that surface water flows away from the MVS.
- Consider local conditions, such as soil type, frost protection, rain amounts, etc. There needs to be at least 300 + 200 mm gravel under the foundation.
- Consider the required cable bending radius and installation room.
- The built-on site user platform around the MVS must be at least one meter (40 in) wide. If it is narrower, service work can be difficult.
- The entire perimeter of the MVS must rest on the foundation.
- Check the load carrying capacity of the ground and potential local special requirements (for example, earthquake or typhoon anchoring) of the construction area. Use materials suitable for the local conditions and requirements.

## Placing the MVS on the foundation

---



### **WARNING!**

Before lifting the MVS onto the foundation, make sure the foundation is aligned well, hardened and stable.

---

1. Measure the level of the foundation and the tilting of the surface of the surrounding ground around the foundation. Obey the [Foundation guidelines \(page 33\)](#).
  2. Make sure the foundation below the MVS is leveled. Inclination up to 0.1 degrees is permitted.
  3. Lift the MVS onto the foundation. Obey the instructions in section [Lifting \(page 29\)](#). Make sure that the foundation does not move. Also make sure that the station is stable and in direct contact with the foundation.
  4. When the MVS is placed on the foundation, measure the height and inclination of the MVS. Check the slope of the surface of the surrounding ground around the MVS.
-

## Fastening the MVS



### WARNING!

Do not fasten the MVS by electric welding, because the welding circuit can damage electronic circuits and integrity of the station. ABB does not assume any liability for damages caused by electric welding.

To fasten the MVS to the foundation, bolt the cabinet through the holes on the base of the inverter or use the supplied attachment brackets (see figure below). Use bolts and washers in each connection point.



**Attachment bracket**



**Placement of bracket**

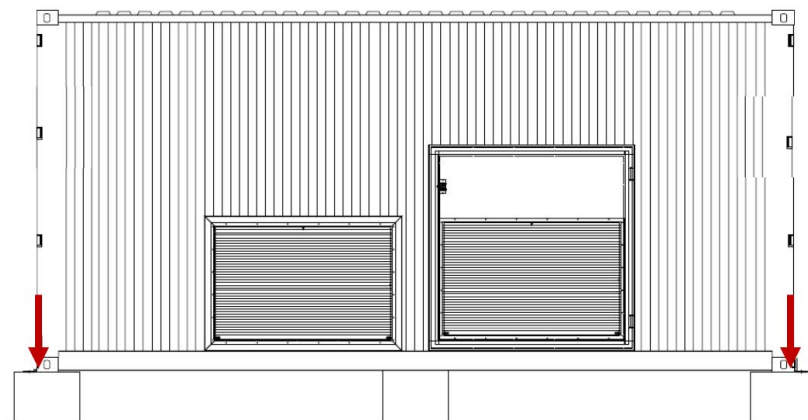

**Fastening points**

Follow the local regulations and applicable standard to calculate the mechanical connections and structural properties. Always consider the site conditions and terrain characteristics.

For more information, see drawing 3AES-PVS-100/120-MVS-30-DW02.

## Constructing earthing electrode and earthing

Construct an earthing electrode for the MVS according to the local regulations. For more information, see drawing 3AES-PVS-100/120-MVS-02-DW02.

## Filling the pit and finalizing the surroundings

1. If required for local frost conditions, add insulation around the column foundation.
2. To minimize the growth of grass, use geotextile below the foundation and below the service platform around the MVS. Put the geotextile 20 cm (8 in) below and about 100 cm (40 in) around the foundation.
3. The MVS is a not walking station, it is designed to be operated from the outside. Provide a permanent or portable platform for comfortable operation of the MVS switching devices as the foundation can be higher than the surrounding ground. For platform design and construction, follow the local rules and standards.

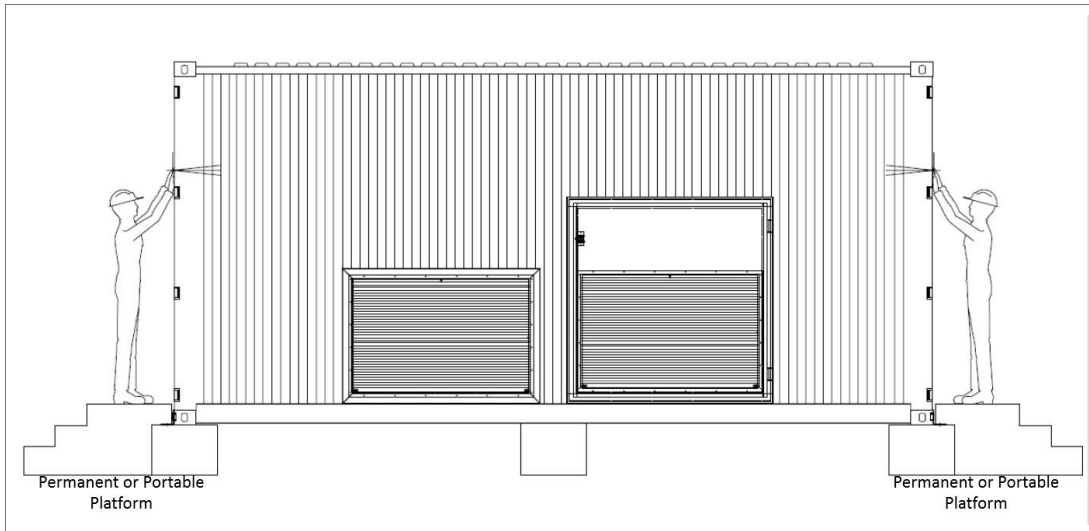

4. Do not plant trees near the MVS. If bushes are planted, make sure that the planting compost base is at least one meter (40 in) away from the station housing and that the fully-grown bushes do not prevent maintenance access to the MVS. Make sure that anything planted near the inverter does not discharge dust or seeds that can affect the cooling air flow.

## Adding weather protection hoods

### ■ Tools

- Lifting crane
- Working platform or ladder
- Automatic screw driver
- Wrench
- Din933 M6x35 – A2 (Inox) screws
- Din9021 M6 – A2 (Inox) + EPDM DIN7712 rubber & metallic washer
- Sealing product - WURTH Klebt + Dichtet (ref #0890100181)



■ **Procedure**

1. Unpack the protection hood.
2. Remove the fans transportation plate



3. Apply the sealing product on hood border.

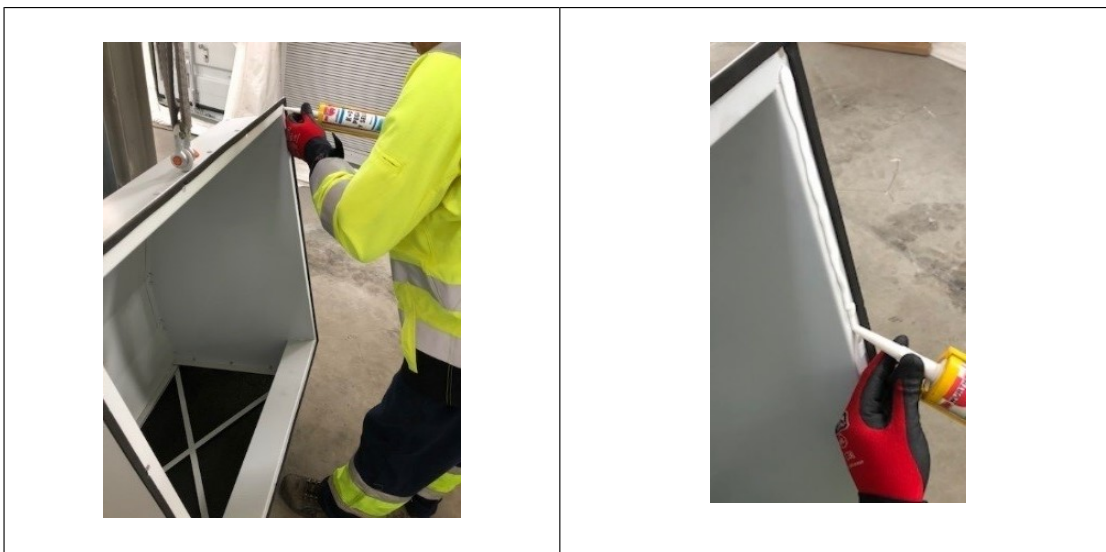

4. Use the lifting crane and place the hood on its frame.



5. Install the washers and screw. For information on torque, see [Tightening torque \(page 56\)](#).

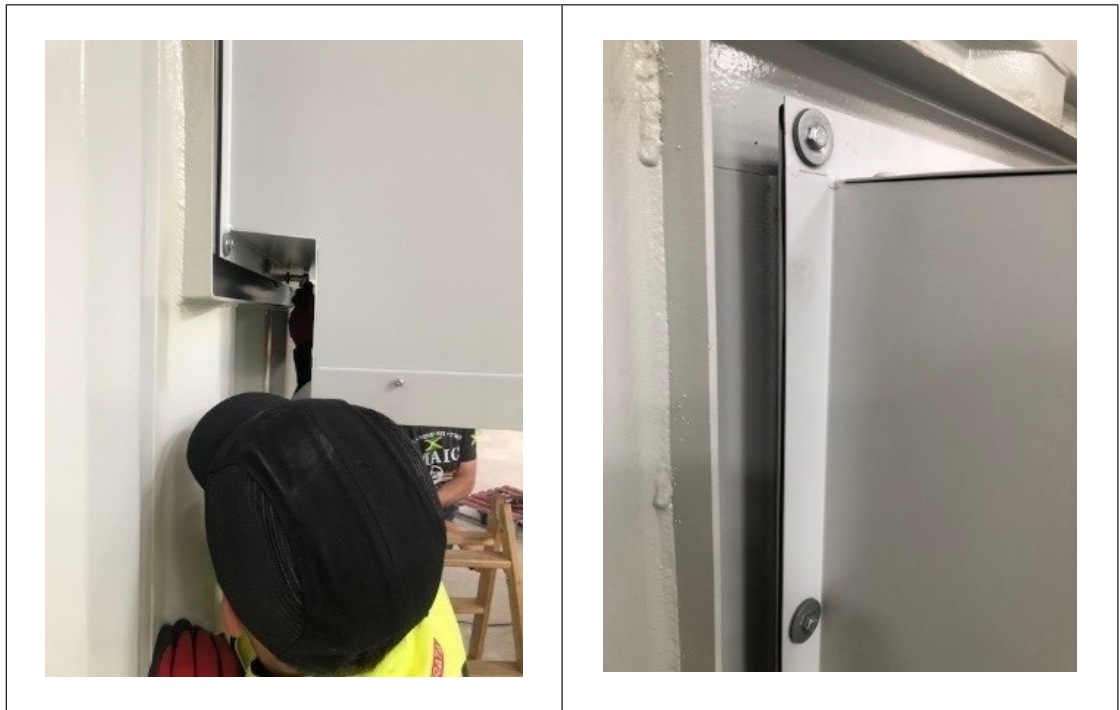

*40 Mechanical installation*

6. Apply a layer of sealant around the hood border.

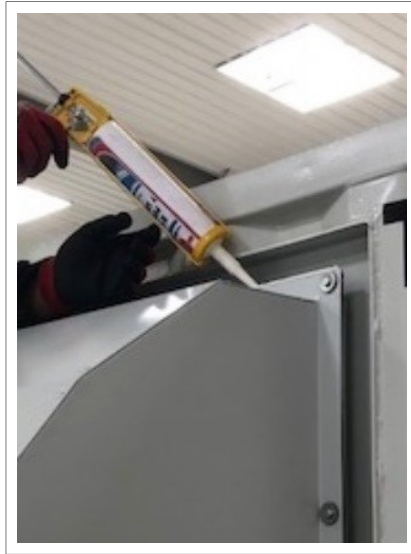



## 5

## Electrical installation

---

### Contents of this chapter

This chapter contains general instructions for earthing and cabling the PVS-100/120 medium voltage station (MVS). Obey all instructions contained in the applicable documentation (such as other hardware manuals) and the local regulations.

---

**WARNING!**

Only an authorized electrician is allowed to install the cabling to the MVS. Obey the [Safety instructions \(page 9\)](#) and the local safety regulations. If ignored, physical injury or death may follow, or damage to the equipment may occur.

---

**WARNING!**

Do not do any electrical installation work during a thunderstorm.

---

**WARNING!**

Make sure that all external cable entries are fully sealed to prevent entry of foreign elements, such as animals and insects.

---



## Routing the cables

When you route the cables:

- Install the AC power cables and the control cables on separate routes.
- Use metallic screen cables for control cables.
- Do not put extra cables through the MVS without permission.

For more information, see drawing 3AES-PVS-100\_120-MVS-01-DW02.

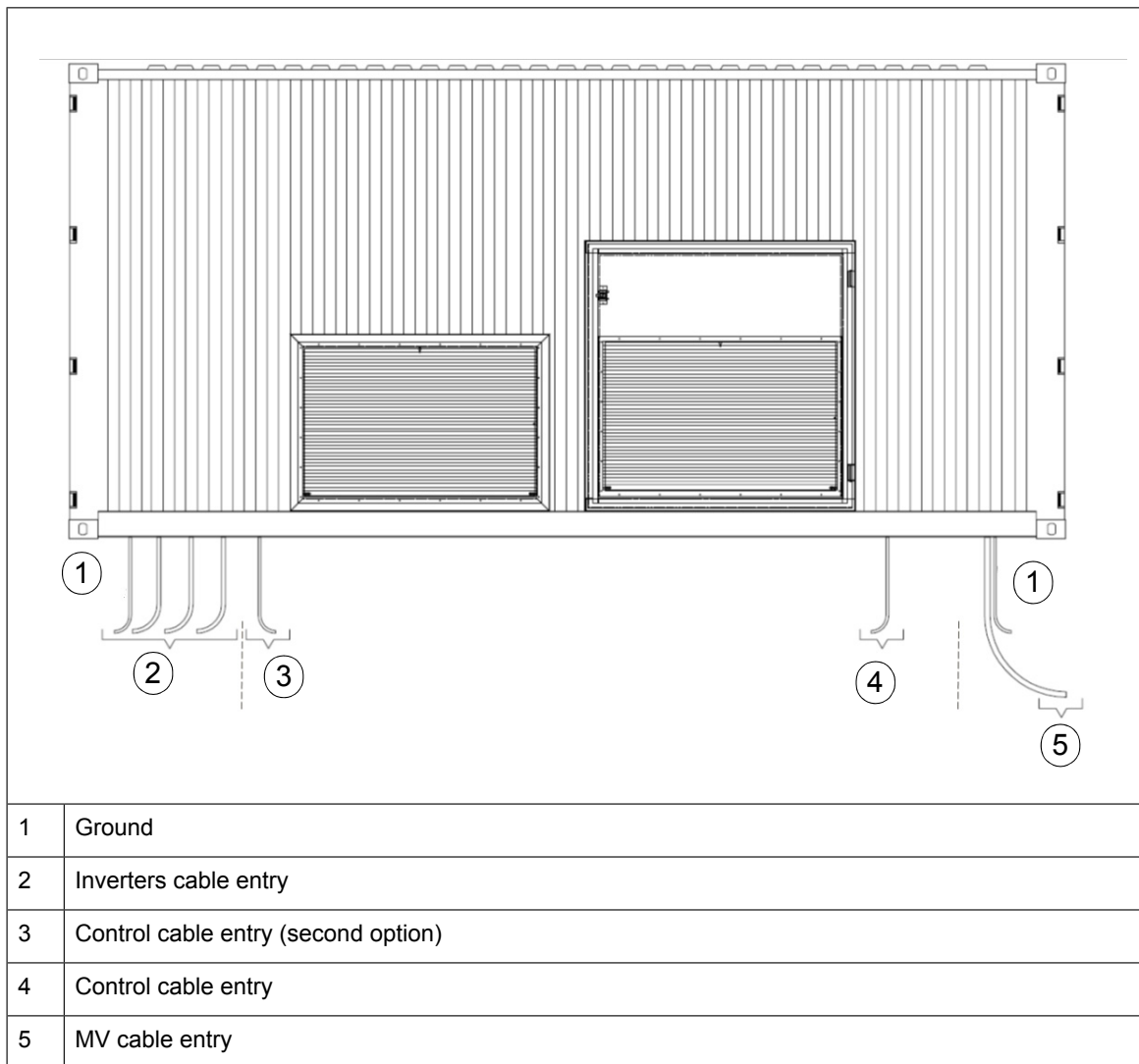

## Earthing

Always construct an earthing electrode for the MVS. Always follow the local regulations.

Follow the minimum requirements for the earthing electrode:

- Minimum cross-sectional area = 95 mm<sup>2</sup>. The plates are prepared for 95 mm<sup>2</sup> cables
- Installation depth = 500...800 mm from the surface of the soil
- Installation route around the MVS = one meter from the outer wall
- Connect the MVS earthing busbar and the station enclosure to the earthing electrode. Use joint lubricant to protect the connection point against corrosion

For more information, see drawing 3AES-PVS-100\_120-MVS-02-DW02.

## Protective earthing (grounding) inside the MVS

The protective earth (PE) terminals or frames of all the main components in the MVS are connected to two main PE busbars located inside the station.

At the installation site:

- measure the continuity of all internal PE connections by measuring the conductivity between each protective earth terminal and the main PE busbar.
- earth the shields, armors and protective conductors of all incoming cables to the appropriate earthing terminals of the station.

For more information, see drawing 3AES-PVS-100\_120-MVS-02-DW02.

## Measuring the insulation resistance of the cabling

Make sure that the insulation resistance of the external power cables are measured according to manufacturer recommendations and local regulations.



## Connecting the inverter inputs

Connect all inverter power cables in the AC cabinet. See details of station type and corresponding inverter type in below table.

Station type	Inverter type
PVS-100-MVS	PVS-100
PVS-120-MVS	PVS-120

To connect the inverter inputs, follow the instructions below:

1. Make sure that all cables have the maximum cable size = 185 mm<sup>2</sup>.
2. Considering the AC cable sizes and that the cables must be aligned with the fuse bases, mark the LV AC lead through holes in the cable cover:

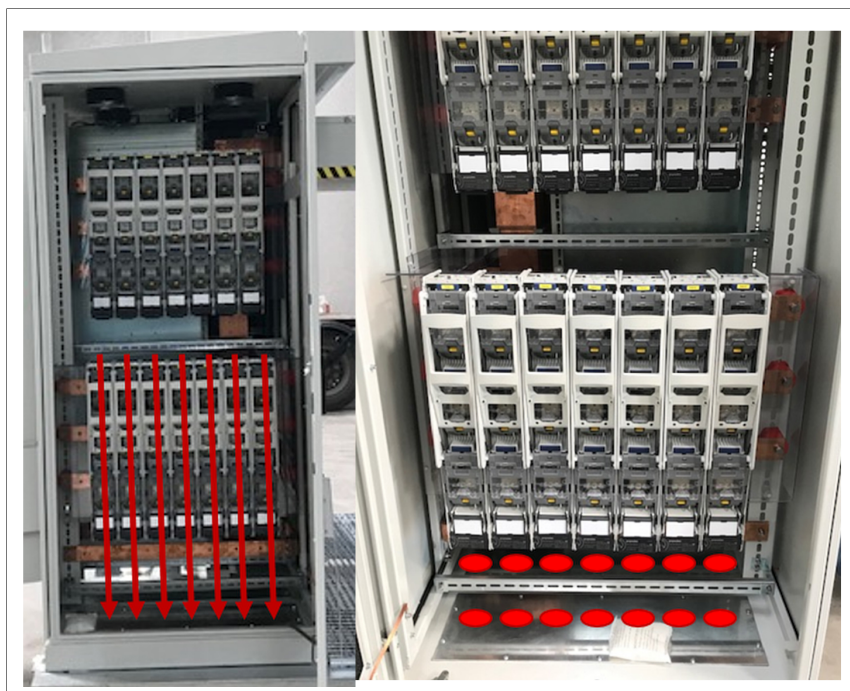

3. Remove the cable entry covers.

4. Drill holes of appropriate sizes in the AC cabinet cover and install cable glands to ensure that IP protection is established.

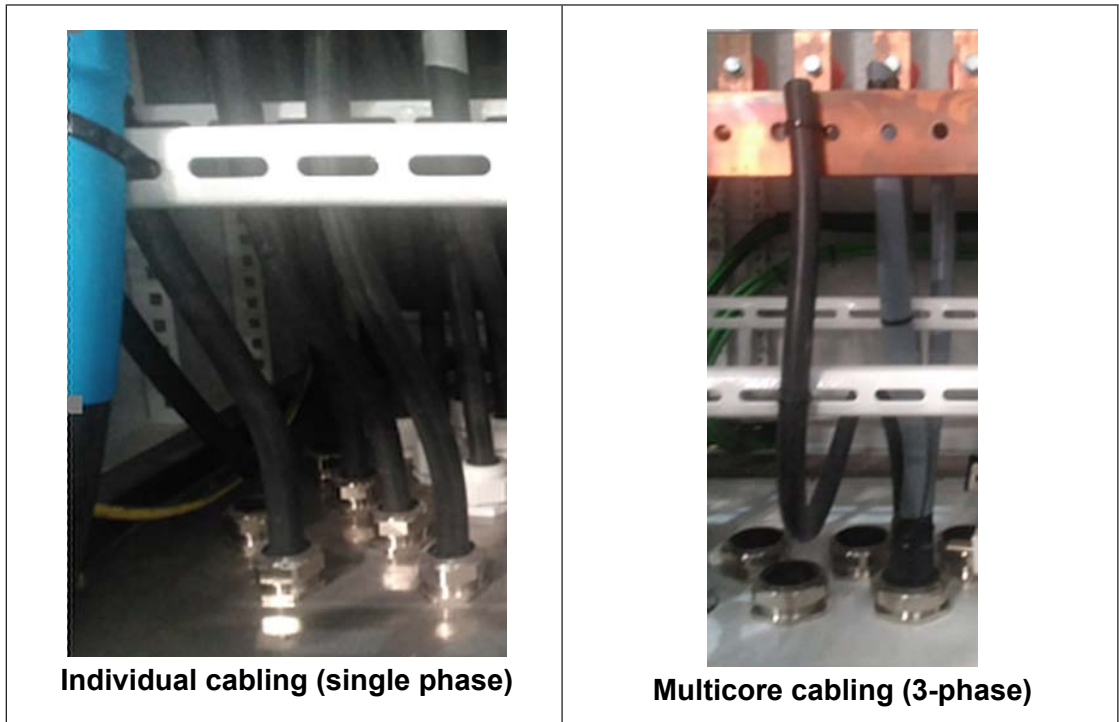

5. Route the cables inside the AC cabinet.
6. Connect the cables to the correct fuse base terminals in the AC cabinet. Tighten the connections.

**Note:**

You can connect the fuse base without terminating the LV AC cables.



## Connecting the communication and auxiliary cabling (Optional)

See the following drawings:

- Auxiliary cabinet drawing—3AES-PVS-100/120-MVS-14-DW03
- Communication cabinet drawing—3AES-PVS-100/120-MVS-15-SL01
- UPS connection drawing—3AES-PVS-100/120-MVS-16-SP01.

To connect the cabling for auxiliary cabinet, communication and UPS:

1. Remove the cable entry covers.
2. Considering the auxiliary cable sizes and their alignment, drill holes of appropriate sizes in the cable covers.
3. Install cable glands to ensure that IP protection is established.
4. Lead the cables into the station.
5. Connect the cables to the correct terminal blocks (communication board and auxiliary service board). Tighten the connections.
6. Fill the cable trenches and seal the cable entries. See chapter *Finalizing the installation* (page 49).

## Connecting the power grid cabling to the MV switchgear

See the MV switchgear manual and the wiring diagrams that is delivered with the MVS.

1. Remove the cable entry covers.
2. Lead the cables into the MVS and seal the cable entries.
3. Terminate the cables according to the cable manufacturer instructions. Connect the cables to the MV switchgear. The standard cable termination (see figure below) installed in MV switchgear is of interface type C with bolted type 400 series.

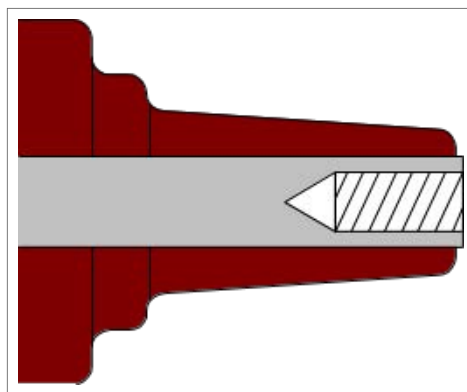

Interface C with M16 x 2 metric threads  
400 series,  $I_n = 630$  A

This termination is standard on all modules and for side connections.

4. Fill the cable trenches and seal the cable entries. For more information, see chapter *Finalizing the installation (page 49)*.
5. Connect the cables to correct terminals.

Maximum MV cable sizes depend on the connector dimensions. See MV switchgear manual to determine the maximum cable size and configuration (see [1YVA000024](#) and [1YVA000026](#)).



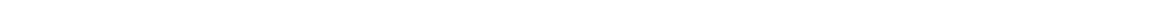



# 6

## Finalizing the installation

---

### Contents of this chapter

This chapter describes how to finalize and check the installation of the PVS-100/120 medium voltage station (MVS). Obey all local regulations.



**WARNING!**

Only an authorized electrician is permitted to install the cabling to the MVS. Obey the [Safety instructions \(page 9\)](#), and the local safety regulations. If ignored, physical injury or death may occur, or cause damage to the equipment.

---



**WARNING!**

Do not do electrical installation work during a thunderstorm.

---



**WARNING!**

Make sure that all external cable entries are fully sealed to prevent entry of foreign elements, such as animals and insects.

---

### Finalizing the installation

- Clean the MVS of all dirt.
  - Repair any damages to the paint surface. See section, [Maintenance of painted surfaces \(page 62\)](#).
  - If not yet done, seal the cable entries, cover the cable entries with sand and sprinkle a handful of cement over the sand. The cement hardens in a few days and it forms a barrier against small animals and plant growth.
-

## Landscaping the station

You can plant suitable bushes around the MVS to landscape it.

Do not plant trees near the station. If bushes are planted, make sure that the planting compost base is at least two meters away from the MVS, and that the fully-grown bushes will not prevent maintenance access. Make sure that the plantation does not discharge dust or seeds that could hinder the cooling air flow.

## Checking the installation of MVS

<b>Item</b>	<input checked="" type="checkbox"/>
Check all mechanical operating functions by operating them twice.	<input type="checkbox"/>
Examine that all cable connections are correctly tightened. <b>Note:</b> Tighten the cable connections of the Switchgear to the MV transformer's bushings. These are delivered loose to prevent damages when transporting the unit	<input type="checkbox"/>
Make sure that the MVS clearance space is maintained. For more information on the required clearance space, see footprint layout 3AES-PVS-100/120-MVS-30-DW02.	<input type="checkbox"/>
Examine the paint surface and repair if any damages found. See instructions in section <a href="#">Maintenance of painted surfaces (page 62)</a> .	<input type="checkbox"/>
Make sure that all cable glands at each cable inlet is installed correctly and all the unused cable openings have protection caps.	<input type="checkbox"/>
Examine the earthing (grounding) of the MVS and its components and make sure that it obeys the earthing (grounding) schematic. Pull the earthing wires at the terminals to ensure that the connections are tight.	<input type="checkbox"/>
Remove any foreign objects such as loose fastenings and tools from the MVS. This can cause short-circuit faults or other damages.	<input type="checkbox"/>
Make sure that the MVS is clean. Contaminated surfaces can increase the risk of corrosion. For more information, see chapter <a href="#">Maintenance (page 55)</a> .	<input type="checkbox"/>
Examine the clearance distances, cable terminations and connections and make sure that all connections are according to the main circuit diagram.	<input type="checkbox"/>
Make sure that the required warning labels are attached to the MVS.	<input type="checkbox"/>
Make sure that the insulation resistance of the external power cables are measured.	<input type="checkbox"/>
Do the installation checks detailed in the device-specific manuals.	<input type="checkbox"/>
Do the inspection procedures required by the respective authorities.	<input type="checkbox"/>

# 7

## Start-up and operation

---

### Contents of this chapter

This chapter describes the start-up procedure of the PVS-100/120 medium voltage station (MVS) and the general operation criteria.

**WARNING!**

Only an authorized electrician is permitted to install the cabling to the MVS. Obey the [Safety instructions \(page 9\)](#) and the local safety regulations. If ignored, physical injury or death, or damage to the equipment may occur.

---

**WARNING!**

Do not do electrical installation work during a thunderstorm.

---



### Tools needed

- Voltage detector
- Insulation resistance meter. For more information, see section [Measuring the insulation resistance of the cabling \(page 43\)](#).
- Personal protective equipment

### Prerequisite

**WARNING!**

Use original silica gel bags only during transport. Install new silica gel bags for storage.

---

1. Remove the transportation covers.
-

2. Remove silica gels.  
See below figure. The locations of silica gels are marked red in color

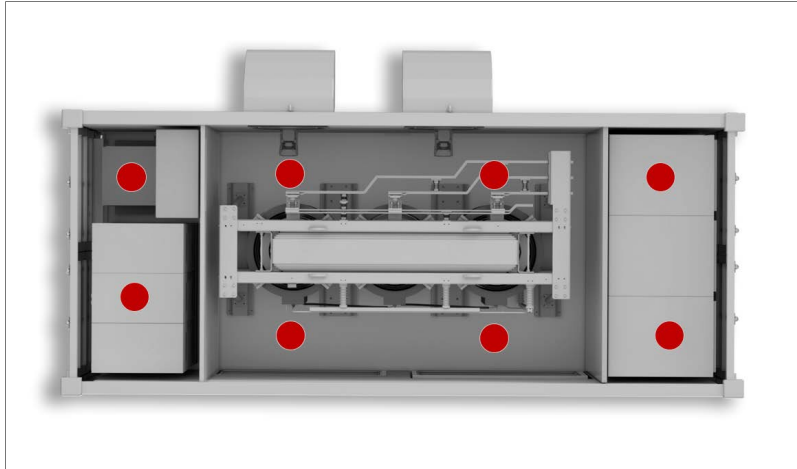

3. Install the external hood for the fan. See [Adding weather protection hoods \(page 37\)](#).
4. Remove the transportation slings. To access MV transformer area, refer the interlocking drawing that is available with the unit.

## Start-up procedure

This section describes the procedure to startup the PVS-100/120 medium voltage station (MVS).



### WARNING!

Only an authorized electrician is permitted to install and perform the start-up procedure. Obey the [Safety instructions \(page 9\)](#) and the local safety regulations. If ignored, physical injury or death, or damage to the equipment may occur.



### WARNING!

Read the manuals and start-up procedures of all other components (inverters, UPS, etc.). Note that the guidelines specified in this section does not replace the instructions given by the product manuals of each component.



Task	Additional information	<input checked="" type="checkbox"/>
Pre-check the MV switchgear.	Check that there is no voltage.	<input type="checkbox"/>
Visually examine the gas level of the MV switchgear.		<input type="checkbox"/>
Finalize the installation and start-up procedure of the MV switchgear.	See MV switchgear manual <a href="#">1YVA000024</a> and <a href="#">1YVA000026</a> .	<input type="checkbox"/>
Finalize the installation and start-up of MV transformer.	Follow the pre-check instructions in the MV transformer manual that is delivered along with the MVS.	<input type="checkbox"/>
Finalize the installation and start-up of the inverters.	See inverter's manual.	<input type="checkbox"/>
<b>Connecting the MVS to power grid</b>		
Make sure all switches, fuses and breakers of the AC cabinet are open.		<input type="checkbox"/>
Make sure that all fuse ratings are appropriate for the cable section and plant security scheme.		<input type="checkbox"/>

Task	Additional information	<input checked="" type="checkbox"/>
Make sure that the main switch of the Auxiliary service transformer is opened.		<input type="checkbox"/>
Make sure that all the local regulations, applicable laws, and standard are met.	Contact your local grid and MV authority.	<input type="checkbox"/>
Turn the earthing switch on the grid side of the MV switchgear to the "not earthed" position.	Applicable for C module MV switchgear	<input type="checkbox"/>
Ask the power grid owner to connect the station to the power grid. Wait until the station is connected to the power grid before proceeding.	Contact your local grid and MV authority. Only authorized personnel are permitted to make the connections.	<input type="checkbox"/>
Turn the disconnecting switch on the grid side of the MV switchgear to Closed position.	Applicable for C module MV switchgear.	<input type="checkbox"/>
Turn the earthing switch on the MV Transformer side of the MV switchgear to the "not earthed" position.	Applicable for V module MV switchgear	<input type="checkbox"/>
Turn the disconnecting switch on the MV transformer side of the MV switchgear to the closed position.	Applicable for V module MV Switchgear	<input type="checkbox"/>
Close the main breaker of the MV transformer.	Applicable for V module MV switchgear	<input type="checkbox"/>
Make sure that the voltage level on the low voltage side of the MV transformer is correct. Adjust the MV transformer tap settings if needed.		<input type="checkbox"/>
Run the MV transformer with no load for several hours.	See MV transformer documentation	<input type="checkbox"/>
Check the MV transformer for any malfunctions. Observe the temperature, listen to audible changes, etc.	See MV transformer documentation	<input type="checkbox"/>
<b>Connecting the AC cabinet</b>		
De-energize the MV transformer.		<input type="checkbox"/>
Close the main switch of the Auxiliary service transformer.	Also de-energize (open) all other switches, disconnectors and breakers of the Auxiliary service board.	<input type="checkbox"/>
Energize the MV transformer.		<input type="checkbox"/>
Close the Auxiliary service transformer primary breaker.		<input type="checkbox"/>
Check that the Auxiliary service transformer secondary winding voltage level is 230/400 V.	Must be 230/400 V $\pm$ 10%	<input type="checkbox"/>
Close the Auxiliary service transformer secondary breaker.		<input type="checkbox"/>
Close the auxiliary breakers one at a time. After closing each breaker, check the voltage values.	Maintain "Closed" condition for the auxiliary service lines with load. Only open switches/breakers with loads.	<input type="checkbox"/>
Close the fuse base switches of the inverter inputs one at a time. Check each fuse base for voltage values directly in the inverter input, before opening the next fuse base.	Inverters must be de-energized. See inverter manual.	<input type="checkbox"/>
Follow the inverter commissioning procedure.	See inverter manual.	<input type="checkbox"/>

If any other optional equipment is integrated into the MVS such as UPS, communication equipment and others, then check the equipment's applicable documentation before executing the start-up procedure.



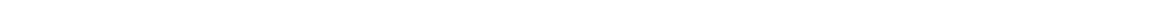



# Maintenance

---

## Contents of this chapter

This chapter contains the preventive maintenance instructions for the PVS-100/120 medium voltage station(MVS). The instructions are intended for certified personnel to perform maintenance tasks.

**WARNING!**

Only an authorized electrician is permitted to do maintenance work on the MVS. Obey the *Safety instructions (page 9)* and follow the local safety regulations. If ignored, physical injury or death, or damage to the equipment may occur.

**WARNING!**

Do not do electrical work during a thunderstorm.

## Tools list

- Torx drivers
  - Philips screwdrivers (PoziDriv)
  - Torque wrench
  - Set of wrenches and sockets
  - Cable and wire strippers
  - Crimping tool and cable lugs
  - Voltage detector
  - Personal protective equipment
-

## Tightening torque

Use the torque values given in the table, unless otherwise specified.

Electrical connections		
Bolt and nuts	Torque	
	Steel: A2-70/A4-70/8.8 (N.m)	Brass (N.m)
M3	0.9	-
M4	2.3	-
M5	4.5	-
M6	8.0	5.0
M8	20	12
M10	40	25
M12	70	40
M14	110	60
M16	170	90
M18	240	120

Mechanical connection <sup>1)</sup>		
Bolt and nuts	Torque	
	Quality 8.8	A2-70/A4-70
M3	1.21	0.85
M4	2.78	0.80
M5	5.5	1.60
M6	9.5	2.80
M8	23	6.8
M10	46	14
M12	79	24
M14	127	37
M16	198	56
M18	283	81
M20	402	114

<sup>1)</sup> Not applicable to threaded inserts



Threaded inserts	
Bolt and nuts	Torque in N.m (steel/ stainless steel)
M5	7.9
M6	12
M8	20
M10	34

## Maintenance intervals

The maintenance and component replacement intervals are based on the specified operational and environmental conditions.

ABB establishes the following as a minimum maintenance schedule. The MVS final maintenance schedule must be adapted and defined by the maintenance responsible of the plant according to the site conditions, operations and others.

Action	Description
I	Visually inspect and perform maintenance if it is necessary.
P	On-site/off-site performance work (commissioning, tests, measurements, etc.)
R	Replace the component.

For more information on maintenance, contact your local ABB service representative.

### ■ Maintenance activities

Perform the following inspections at least once in every six months.

Action	Task
I	Check the operating environment, surroundings and conditions.
I	Check the availability of spare parts.
I	Check for any dust, corrosion, etc. inside and outside the MVS.
I	Check and clean the inlet and outlet grills & filters.
I	Check the sealing of all cable entries to ensure that the IP protection level is maintained.
I	Clean the filters of the air inlet and outlet.
I	Examine the tightness and cleanliness of the main circuit terminals and earth connections.
I	Inspect the general conditions of the MVS (door sealing, cooling fan operation, etc.)
I	Inspect the operation of locks, hinges, and gaskets.
I	Check that all labels are readable and in proper conditions.
I	Examine the condition of the foundation.
I	Check the maintenance activities of each component in its respective user manual (MV Transformer, MV Switchgear, AASS Transformer etc) .

Action	Task
I	Inspect the temperature and operating conditions of the AC Cabinet using thermography .
I	Examine the grounding system conductivity. This must be done in accordance to local regulation and standards.

■ **Maintenance intervals**

Component	Years from start-up or interval	
	10	20
Cooling fans	R	R
Air filters	R (every six months)	
UPS	Obey manufacturer instructions	

## Cleaning procedure

Perform the following inspections at least once in every six months.



**WARNING!**

Obey the *Safety instructions (page 9)* and the local safety regulations. If ignored, physical injury or death, or damage to the equipment may occur.



**WARNING!**

Read the manuals of other components (inverters, UPS, etc.). The guideline specified in this section does not replace the instructions given by the product manuals of each component.

Task	Additional information	<input checked="" type="checkbox"/>
Pre-check that there are safe conditions before starting any cleaning procedure.		<input type="checkbox"/>
<b>Cleaning the MVS</b>		
Use pressurized air to clean the external enclosure, floors. and gutters.		<input type="checkbox"/>
Use pressurized air to clean all air inlets and outlets including grills.		<input type="checkbox"/>
<b>Cleaning the AC Cabinet</b>		
Use a vacuum cleaner to clean the floor, doors and interior beams.	If necessary, use a duster or pressurized air to clean locations you cannot reach with the vacuum cleaner.	<input type="checkbox"/>
Remove dust from the air inlets and outlets.		<input type="checkbox"/>
Use pressurized air to clean locations with excessive dust, including busbar connections.		<input type="checkbox"/>
<b>Cleaning the inverters</b>		
Follow the instructions in the inverters manual.		<input type="checkbox"/>
<b>Cleaning the MV transformer area</b>		
Make sure that the MV and auxiliary transformers have cooled down.		<input type="checkbox"/>

Task	Additional information	<input checked="" type="checkbox"/>
Use a vacuum cleaner to clean the floor, doors and interior beams.		<input type="checkbox"/>
Use a pressurized air to clean the general dust in the MV transformer surface and locations with excessive dust.	See MV transformer manual.	<input type="checkbox"/>
Use pressurized air to clean locations with excessive dust, including busbar connections.		<input type="checkbox"/>
Clean the surface of the MV transformer with a duster or compressed air.		<input type="checkbox"/>
Clean the insulators of the MV transformer		<input type="checkbox"/>
<b>Cleaning the air filters</b>		
Clean the air filters by blowing compressed air from the inside to the outside through the filter until the dust comes off.		<input type="checkbox"/>
Loosen and remove the screws on the filter frame.		<input type="checkbox"/>
Remove the plastic clips and then, remove the grid.		<input type="checkbox"/>
Clean the grill interior with a vacuum cleaner.		<input type="checkbox"/>
Install the filter support frames and tighten the screws.		<input type="checkbox"/>
<b>Cleaning the fans</b>		
Turn OFF/OPEN the circuit breaker for fan.	Prevent the circuit breaker from turning on accidentally.	<input type="checkbox"/>
Disconnect the supply and signal cabling.	Measure to make sure that it is not energized.	<input type="checkbox"/>
Use compressed air to clean the fans.		<input type="checkbox"/>
<b>Cleaning the free area</b>		
Use a vacuum cleaner to clean the floor, doors and interior.	If necessary, use a duster or pressurized air to clean locations you cannot reach with the vacuum cleaner.	<input type="checkbox"/>
<b>Cleaning the MV switchgear area</b>		
Use a vacuum cleaner to clean the floor, doors and interior metal beams.	If necessary, use a duster or pressurized air to clean locations you cannot reach with the vacuum cleaner.	<input type="checkbox"/>

## Replacing component

1. Loosen and remove the external screws of the ventilation grille.

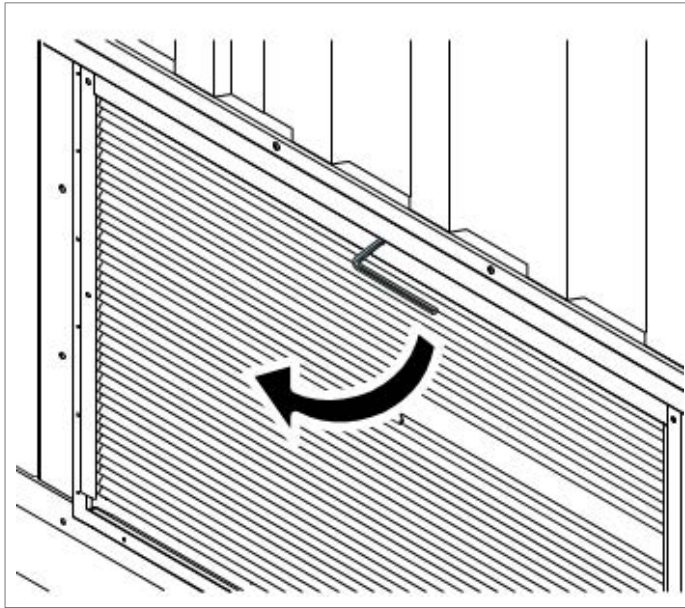

2. Pull the top edge and open the ventilation grille.

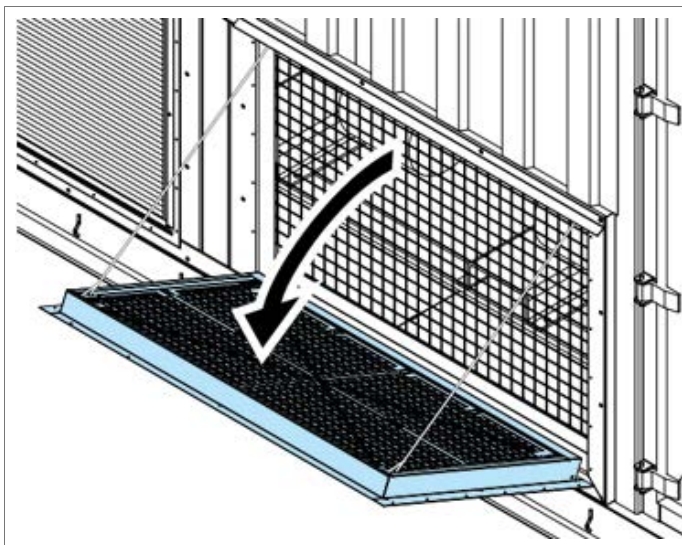

3. Pull the air filter frame from the ventilation grille.

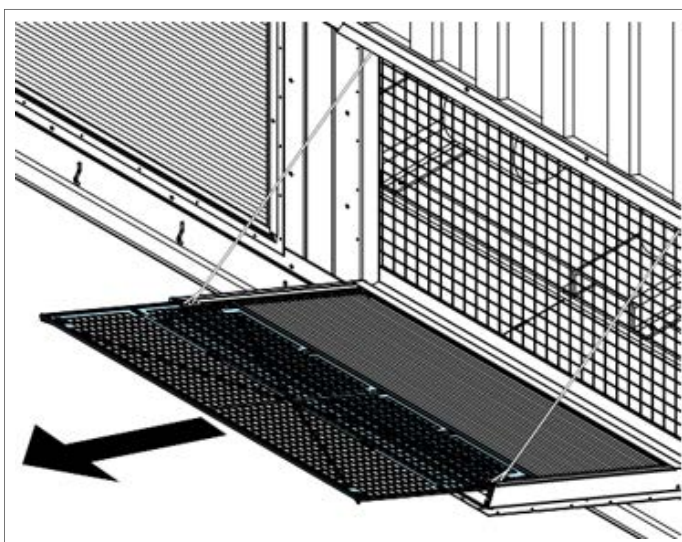

4. Remove the plastic clips and the air filter support from the air filter frame.
5. Check and clean the ventilation grille with a vacuum cleaner.
6. Clean the air filters with compressed air.



**WARNING!**

Make sure that the dust does not enter into the MVS. This can cause damage to the equipment.

---

Note: If required, you can replace the air filter and plastic clips.

7. Install the air filter into the ventilation grille.
  8. Close the ventilation grille.
  9. Tighten the screws.
-

## Maintenance of painted surfaces



### WARNING!

Obey the *Safety instructions (page 9)* and the local safety regulations. If ignored, physical injury or death, or damage to the equipment may occur.



### WARNING!

Obey the *Safety instructions (page 9)*, requirements and specifications of the primer and paint manufacture.

## ■ Repainting the scratched areas

### Tools and materials

Use the following tools and materials. If the listed tools are not available in your local market, you can use products with similar characteristics approved by a qualified technician, and get approval from ABB.

Tool	Specification	Make
Flap Disc	1 ud	Silver P80 Triton
Grinding machine	1 ud	Bosch
Flexible abrasive sponges	10 ud	Ehs
Degreasing sprays	250 ml	-
Body shop putties	1 ud	Finissage, Impa
Rags or blower	200 gr	-
Disposable gloves	10 ud	-
Safety glasses	1 ud	Uvex Astrospec
Masks	2 ud	-
Brushes	2 ud	-
Epoxy primer	500 gr	Maper
Aliphatic polyurethane	500 gr	Maper

### Painting the damaged surface (no visible rust)

If there is damage(s) to the paint surface, but no damages to the metal surface (i.e. no visible rust), then follow these instructions:

1. Clean the damaged area first with a suitable detergent and clean water.
2. Let the surface dry completely and keep it clean.
3. Apply the first layer of paint to the damaged area. Let it dry thoroughly for at least 12 hours.
4. Apply the second layer of paint to the damaged area.

### Painting the damaged surface (visible rust)

If the damage extends to the metal surface or there is visible rust:

1. Remove the rust with sandpaper/polishing disk.

2. Clean the damaged area and its surroundings using a cloth or blower.
3. If necessary, apply putty to even out the surface.
4. Coat the damaged area with an epoxy primer. Let it dry thoroughly (for at least 24 hours).
5. Apply first layer of paint to the damaged area. Let it dry thoroughly (for at least 12 hours).
6. Apply second layer of paint to the damaged area.
7. Apply final layer (e.g. Aliphatic Polyurethane coating).

#### ■ Maintenance of Zinc coated surfaces

Pay attention to doors and lower parts of the walls. These areas have potentially corrosive elements such as dust and humidity.

If there is damage to the zinc-coating:

1. Carefully remove any rust with sandpaper.
2. Clean the damaged area and its surroundings.
3. Coat the damaged area with the zinc coating. Use Würth Zinc 300 for a thicker coat. On large areas, you can use Würth Zinc Spray Perfect to ease the work and to get an even surface.

## Maintenance of grounding bars and points

#### ■ Tools

- Steel wool
- Ensto SR1 joint compound or equivalent
- 42839 Würth protective wax or equivalent

#### ■ Procedure

1. Examine the condition of the grounding bar and grounding cables in the MV switchgear area. If there is any visible corrosion, remove the cables and remove the corrosion with steel wool. Apply joint compound between the grounding bar and the joint surfaces of the cable terminal.
2. Change the spring lock washers. Tighten the cables to the nominal torque values.
3. If corrosion is more, apply protective wax spray on the grounding bar and the cable terminals.

## Maintaining external hinges and locks

#### ■ Tools

- Cleaning materials
- Hinge lubricant, Würth HHS20000 0893 106 or equivalent
- Lock lubricant, Würth maintenance spray 0893 051 or equivalent.

#### ■ Procedure

1. To maintain the external hinges and locks, use the recommended lubricants and lubricate the locks and hinges.



**WARNING!** Do not use lubricants with silicone.

---

2. After lubricating, clean the excess lubricant.

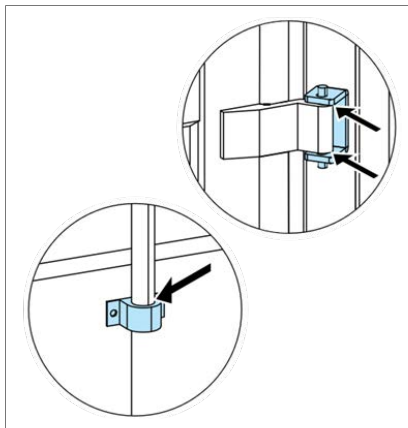

## Replacing the door limit switch



### **WARNING!**

Make sure that the circuit breaker is open and cannot be closed accidentally when performing the task.

1. Open the main circuit breaker of the auxiliary panel.
2. Check and make sure that no voltage is connected to the limit switch door and the light lane.
3. Loosen the limit switch screws.
4. Replace the limit switch and verify the connections and operation. For more information, refer to the sensor manual.
5. Close the circuit breaker and make sure that the door limit switch operates as expected.





## Technical data

---

### Contents of this chapter

This chapter contains the technical data of the PVS-100/120 medium voltage station (MVS).

---

## Technical data and types: PVS-100 MVS

Data	Type code (PVS-100-TL-...)									
	800	1000	1200	1400	1600	1800	2000	2200	2400	2600
Number of inverters in parallel	8	10	12	14	16	18	20	22	24	26
Maximum rating in kVA	800	1000	1200	1400	1600	1800	2000	2200	2400	2600
<b>LV distribution panel</b>										
Number of fuse protected feeders	8	10	12	14	16	18	20	22	24	26
Fuse rating of feeders	200 A									
Breakable on load	Yes									
Over voltage protection - replaceable surge arrester	Type 2 (type 1 + 2 optional)									
<b>MV transformer</b>										
Transformer type	Vacuum cast coil dry type (AF)									
AC power at 30°C in kVA	800	1000	1200	1400	1600	1800	2000	2200	2400	2600
AC power at 40°C in kVA	800	1000	1200	1400	1600	1800	2000	2200	2400	2600
Low voltage level	400 V									
Medium voltage level range	≤ 36 kV									
Rated frequency	50 Hz or 60 Hz									
Tap changer	± 2 x 2.5%									
Winding material (primary / secondary)	Al/ Al									
Eco efficiency optional	Yes									
<b>MV switchgear</b>										
Switchgear type	ABB SafePlus (SF <sub>6</sub> -insulated)									
Rated current	630 A									
Configuration	Single (CV) or double feeder (CCV)									
Protection (up to 24 kV / up to 36 kV)	Circuit breaker (16 kA or 20 kA / 20 kA or 25 kA)									
Protection relay type	ABB REJ603 (others on request)									
Motorized optional	Yes									
<b>Auxiliary supply</b>										
Auxiliary transformer power	10 kVA (higher on request)									
Auxiliary transformer voltage	400 / 400-230 V									
Low voltage distribution panel for auxiliary functions	Yes									
<b>Mechanical characteristics</b>										
Length, Width, Height (L × W × H)	5700 x 2150 x 2500 mm									
Weight approx. ton	7	7	7	7	8	8	8	9	9	9
<b>Environmental</b>										
Operating temperature range	-25°C ... +60°C (with derating above 40 C)									
Operating altitude range	≤ 2000 m									

Data	Type code (PVS-100-TL-...)									
	800	1000	1200	1400	1600	1800	2000	2200	2400	2600
Relative humidity (non-condensing)	≤ 95%									
Environmental protection rating	IP 54									
Painting corrosion protection	C4 (C5M optimal)									
<b>Product compliance</b>										
Conformity	IEC 60364, IEC 61936-1, IEC 60502-1									

## Technical data and types: PVS-120 MVCS

Data	Type code (PVS-120-TL-...)									
	960	1200	1440	1680	1920	2160	2400	2640	2880	3120
Number of inverters in parallel	8	10	12	14	16	18	20	22	24	26
Maximum rating in kVA	960	1200	1440	1680	1920	2160	2400	2640	2880	3120
<b>LV distribution panel</b>										
Number of fuse protected feeders	8	10	12	14	16	18	20	22	24	26
Fuse rating of feeders	200 A									
Breakable on load	Yes									
Over voltage protection - replaceable surge arrester	Type 2 (type 1 + 2 optional)									
<b>MV transformer</b>										
Transformer type	Vacuum cast coil dry type (AF)									
AC power at 30°C in kVA	960	1200	1440	1680	1920	2160	2400	2640	2880	3120
AC power at 40°C in kVA	960	1200	1440	1680	1920	2160	2400	2640	2880	3120
Low voltage level	480 V									
Medium voltage level range	≤ 36 kV									
Rated frequency	50 Hz or 60 Hz									
Tap changer	± 2 x 2.5%									
Winding material (primary / secondary)	Al/ Al									
Eco efficiency optional	Yes									
<b>MV switchgear</b>										
Switchgear type	ABB SafePlus (SF <sub>6</sub> -insulated)									
Rated current	630 A									
Configuration	Single (CV) or double feeder (CCV)									
Protection (up to 24 kV / up to 36 kV)	Circuit breaker (16 kA or 20 kA / 20 kA or 25 kA)									
Protection relay type	ABB REJ603 (others on request)									
Motorized optional	Yes									
<b>Auxiliary supply</b>										
Auxiliary transformer power	10 kVA (higher on request)									
Auxiliary transformer voltage	480 / 400-230 V									
Low voltage distribution panel for auxiliary functions	Yes									
<b>Mechanical characteristics</b>										
Length, Width, Height (L × W × H)	5700 x 2150 x 2500 mm									
Weight approx. ton	7	7	7	7	8	8	9	9	10	11
<b>Environmental</b>										
Operating temperature range	-25 C ... +60 C (with derating above 40 C)									
Operating altitude range	≤ 2000 m									

Data	Type code (PVS-120-TL-...)									
	960	1200	1440	1680	1920	2160	2400	2640	2880	3120
Relative humidity (non-condensing)	≤ 95%									
Environmental protection rating	IP 54									
Painting corrosion protection	C4 (C5M optimal)									
<b>Product compliance</b>										
Conformity	IEC 60364, IEC 61936-1, IEC 60502-1									





## Drawings

---

### Contents of this chapter

This chapter contains the technical drawings of PVS-100/120 medium voltage station (MVS).

### List of technical drawings

The list includes two types of drawings:

- Product Series—Standard product series drawings that can be consulted prior to the purchase of the unit.
- Project Specific—Drawings specific to a project that are delivered with the unit, only on request.

Drawing code	Description	Type
3AES-PVS-100_120-MVS-01-DW01	Single Line Diagram	Product Series
3AES-PVS-100_120-MVS-02-DW01	Electrical Layout	Product Series
3AES-PVS-100_120-MVS-02-DW02	Grounding Layout	Product Series
3AES-PVS-100_120-MVS-30-DW01	Dimensional Layout	Product Series
3AES-PVS-100_120-MVS-30-DW02	Footprint	Product Series
3AES-PVS-100_120-MVS-14-DW03	Auxiliary Cabinet	Project Specific
3AES-PVS-100_120-MVS-15-SL01	Communication Cabinet	Project Specific (if applicable)
3AES-PVS-100_120-MVS-16-SP01	UPS Connection	Project Specific (if applicable)

---





---

## Further information

### **Product and service inquiries**

Address any inquiries about the product to your local ABB representative, quoting the type designation and serial number of the unit in question. A listing of ABB sales, support and service contacts can be found by navigating to [new.abb.com/power-converters-inverters/solar](http://new.abb.com/power-converters-inverters/solar).

### **Product training**

For information on ABB product training, navigate to [new.abb.com/service/training](http://new.abb.com/service/training).

### **Providing feedback on ABB Drives manuals**

Your comments on our manuals are welcome. Navigate to [new.abb.com/power-converters-inverters/document-library](http://new.abb.com/power-converters-inverters/document-library).

### **Document library on the Internet**

You can find manuals and other product documents in PDF format on the Internet at [new.abb.com/power-converters-inverters/document-library](http://new.abb.com/power-converters-inverters/document-library)



[www.abb.com/drives](http://www.abb.com/drives)



3AES-PVS-100/120-MVS-00-MA01-AA