



Product Manual

# **REACT 2**

(3.6 to 5.0 kW)

## IMPORTANT SAFETY INSTRUCTIONS



*This manual contains important safety instructions that must be followed during the installation and maintenance of the equipment.*

## SAVE THESE INSTRUCTIONS!



*Keep this document in a safe place near the inverter for easy access during installation, operation and maintenance.*

## THE INSTALLER MUST READ THIS DOCUMENT IN ITS ENTIRETY BEFORE INSTALLING THIS EQUIPMENT.

*Operators are required to read this manual and scrupulously follow the instructions given in it, since FIMER cannot be held responsible for damage caused to people and/or things, or the equipment, if the conditions described below are not observed.*

*The purpose of this document is to support the qualified technician, who has received training and/or has demonstrated skills and knowledge in construction, to install, operate and maintain the inverter. This manual covers only inverter, not any equipment (photovoltaic modules, external disconnects, etc) to which it is connected.*

*Warranty requirements are included in the Terms and Conditions of sale included with the inverter order.*

*NOTE: Any changes made to the product or to the installation conditions that hasn't been approved by FIMER will void the warranty.*



*All pictures and illustrations shown in this user manual are indicatives and must be intended as support for installation instruction only. Actual product may vary due to product enhancement. Specifications subject to change without notice. The latest version of this document is available on the FIMER website.*



*The products are designed to be connected to and to communicate information and data via a network interface. It is the user's sole responsibility to provide and continuously ensure a secure connection between the product and the user's network or any other network (as the case may be). The user shall establish and maintain any appropriate measures (such as but not limited to the installation of firewalls, application of authentication measures, encryption of data, installation of anti-virus programs, etc) to protect the product, the network, its system and the interface against any kind of security breaches, unauthorized access, interference, intrusion, leakage and/or theft of data or information. FIMER and its affiliates are not liable for damages and/or losses related to such security breaches, any unauthorized access, interference, intrusion, leakage and/or theft of data or information. The data, examples and diagrams in this manual are included solely for the concept or product description and are not to be deemed as a statement of guaranteed properties. All persons responsible for applying the equipment addressed in this manual must satisfy themselves that each intended application is suitable and acceptable, including that any applicable safety or other operational requirements are complied with. In particular, any risks in applications where a system failure and/or product failure would create a risk for harm to property or persons (including but not limited to personal injuries or death) shall be the sole responsibility of the person or entity applying the equipment, and those so responsible are hereby requested to ensure that all measures are taken to exclude or mitigate such risks. This document has been carefully checked by FIMER but deviations cannot be completely ruled out. In case any errors are detected, the reader is kindly requested to notify the manufacturer. Other than under explicit contractual commitments, in no event shall FIMER be responsible or liable for any loss or damage resulting from the use of this manual or the application of the equipment.*

# **Product Manual**

## **REACT2-3.6/5.0 photovoltaic system with storage**

### **1 - Introduction and general information**

### **2 - Characteristics**

### **3 - Safety and accident prevention**

### **4 - Lifting and transport**

### **5 - Installation**

### **6 - Instruments**

### **7 - Operation**

### **8 - Maintenance**

### **9 - Attachments**

### Warranty and supply conditions

The warranty conditions are considered to be valid if the Customer adheres to the indications in this manual; any conditions deviating from those described herein must be expressly agreed in the purchase order.

*FIMER declares that the equipment complies with the provisions of law currently in force in the country of installation and has issued the corresponding declaration of conformity.*

#### Not included in the supply

*FIMER accepts no liability for failure to comply with the instructions for correct installation and will not be held responsible for systems upstream or downstream of the equipment it has supplied.*



*It is absolutely forbidden to modify the equipment. Any modification, manipulation, or alteration not expressly agreed with the manufacturer, concerning either hardware or software, shall result in the immediate cancellation of the warranty.*

*The customer is fully responsible for any changes made to the system.*

Given the countless array of system configurations and installation environments possible, it is essential to check the following: adequate spaces, suitable for housing the equipment; airborne noise produced based on the environment; possible flammability conditions.

FIMER will NOT be held liable for defects or malfunctions arising from: improper use of the equipment; deterioration resulting from transportation or particular environmental conditions; performing maintenance incorrectly or not at all; tampering or unsafe repairs; use or installation by unqualified persons.

FIMER is not responsible for any loss of the equipment, or part of it, which does not take place on the basis of the regulations and laws in force in the country of installation.

## Table of content

<b>Introduction and general information.....</b>	<b>4</b>
<b>Warranty and supply conditions.....</b>	<b>4</b>
Not included in the supply.....	4
<b>Table of content .....</b>	<b>5</b>
<b>Reference number index .....</b>	<b>9</b>
<b>Graphical representation of references .....</b>	<b>10</b>
REACT2-UNO-3.6/5.0-TL (external view) .....	10
REACT2-BATT (external view) .....	10
REACT2-UNO-3.6/5.0-TL (internal view) .....	11
REACT-MTR-1PH.....	12
Meter FIMER B21 .....	12
Meter B23, B24 .....	12
<b>Scope and target audience.....</b>	<b>13</b>
Purpose and document structure .....	13
List of appendix documents .....	13
Operator and maintenance personnel skills/prerequisites .....	13
<b>Symbols and signs.....</b>	<b>14</b>
<b>Field of use, general conditions .....</b>	<b>16</b>
Intended or allowed use.....	16
Limits in field of use.....	16
Improper or disallowed use .....	17
<b>Characteristics .....</b>	<b>17</b>
<b>General conditions .....</b>	<b>17</b>
<b>Models and range of equipment.....</b>	<b>18</b>
Identification of the equipment and manufacturer .....	19
Communication identification label .....	20
<b>Characteristics and technical data.....</b>	<b>21</b>
Tightening torques .....	24
Overall dimensions REACT2-3.6/5.0-TL-OUTD .....	25
Overall dimensions REACT-MTR-1PH.....	26
Overall dimensions Meter FIMER B21 .....	26
Overall dimensions Meter FIMER B23, B24.....	26
Dimensions bracket REACT2-UNO-3.6/5.0-TL.....	27
Dimensions bracket REACT2-BATT.....	28
<b>Efficiency curves .....</b>	<b>29</b>
<b>Power limitation (Power Derating).....</b>	<b>30</b>
Power reduction due to environmental conditions.....	30
Power reduction due to the altitude of the installation .....	31
Output power reduction due to the input voltage.....	32
Input power reduction due to the input voltage .....	33
P- Q curve capability .....	34
<b>Characteristics of a photovoltaic generator.....</b>	<b>35</b>
Strings and Arrays.....	35
<b>Description of the REACT2 system.....</b>	<b>36</b>
Notes on the sizing of the system.....	36
Operating diagram .....	37

Connectivity diagram .....	38
Operating stages of the system .....	39
Functionality and components of the equipment.....	40
Topographic diagram of the equipment .....	42
<b>Safety devices.....</b>	<b>43</b>
Anti-Islanding .....	43
Ground fault of the photovoltaic panels .....	43
REACT2-BATT state of health (SOH) .....	43
Other safeguards .....	43
<b>Safety and accident prevention .....</b>	<b>44</b>
<b>Safety information and instructions .....</b>	<b>44</b>
<b>Hazardous areas and operations .....</b>	<b>45</b>
Environmental conditions and risks .....	45
Signs and labels.....	45
Thermal and electrical hazard .....	46
Clothing and protection of personnel.....	46
Safety precautions relating to REACT2-BATT.....	47
<b>Residual risks .....</b>	<b>49</b>
Table of residual risks .....	49
<b>Lifting and transport.....</b>	<b>50</b>
<b>General conditions .....</b>	<b>50</b>
<b>Storage of equipment.....</b>	<b>51</b>
Special rules for storage of REACT2-BATT .....	51
<b>Lifting .....</b>	<b>52</b>
Equipment weight .....	52
<b>Transport of the equipment.....</b>	<b>53</b>
Road transport of Battery Unit .....	53
<b>Unpacking and checking .....</b>	<b>54</b>
General Handling Information.....	54
List of components supplied .....	54
<b>Installation .....</b>	<b>56</b>
<b>General conditions .....</b>	<b>56</b>
Environmental checks.....	57
Wireless signal environmental checks.....	59
Installations above 2000 metres .....	60
Installations with a high level of humidity .....	60
<b>Mounting instruction - REACT2 system .....</b>	<b>61</b>
<b>Mounting instruction - REACT2 multi battery system .....</b>	<b>65</b>
<b>Connection of the energy meter .....</b>	<b>67</b>
Connection and configuration of the FIMER B21 meter (single-phase) .....	71
Connection and configuration of the REACT-MTR-3PH (three-phase) .....	73
<b>Distribution grid output connection (AC side).....</b>	<b>75</b>
Characteristics and sizing of the line cable .....	75
Load protection switch (AC disconnect switch) .....	76
Installation of the cable on the AC output connector .....	76
Connection for the AC output connector to the inverter .....	78
Installation of the external protective grounding cable .....	79
<b>BACKUP output connection (AC).....</b>	<b>80</b>
Characteristics and sizing of the cable for BACKUP output.....	81
Load protection switch (AC disconnect switch) for BACKUP output.....	81

Connection to AC BACKUP output terminal block .....	81
<b>Preliminary operations for connection of the PV generator .....</b>	<b>82</b>
Checking the correct polarity of the strings .....	82
Checking of leakage to ground of the photovoltaic generator .....	82
Selection of differential protection downstream of the inverter .....	82
<b>Configuration of independent or parallel input channels.....</b>	<b>84</b>
Channel configuration examples .....	85
Independent channel configuration (default configuration) .....	86
Configuration of parallel-connected channels .....	86
<b>Input connection to PV generator (DC side) .....</b>	<b>87</b>
Installation procedure for quick-fit connectors .....	88
<b>Communication and control signal connections .....</b>	<b>92</b>
External backup command connection .....	93
Remote control connection .....	93
+5V output connection .....	94
Connection of RS485 LOGGER serial communication line .....	94
Ethernet connection .....	96
Configurable Relay connection (OUTPUT 1 and OUTPUT 2) .....	98
<b>Instruments.....</b>	<b>97</b>
<b>General conditions .....</b>	<b>97</b>
<b>User interface.....</b>	<b>98</b>
Description of the synoptic.....	98
Embedded Web User Interface .....	98
Aurora Vision Plant Management Platform .....	98
FIMER Ability™ Energy Viewer for solar plants .....	99
Measurement tolerance .....	99
<b>Operation .....</b>	<b>100</b>
<b>General conditions .....</b>	<b>100</b>
<b>Commissioning.....</b>	<b>101</b>
Free@Home protocol activation .....	108
<b>Synoptic icons behaviour.....</b>	<b>109</b>
Red GFI LED.....	110
<b>Description of the Web User Interface .....</b>	<b>111</b>
Access to the Web User Interface .....	111
Web User Interface menu structure.....	114
MAIN section.....	115
SETTING section .....	116
Inverter Log .....	122
USER section.....	123
Connectivity .....	124
Service TOOLS .....	126
Information .....	129
<b>Inverter switch-off.....</b>	<b>130</b>
Operator and maintenance personnel skills/prerequisites .....	130
Switch-off procedure .....	131
<b>Maintenance .....</b>	<b>133</b>
<b>General conditions .....</b>	<b>133</b>
Routine maintenance .....	134
Troubleshooting .....	134
Alarm Messages .....	135

Power limitation messages .....	143
<b>Procedure for dismantling of the REACT2 system .....</b>	<b>145</b>
<b>Registration on website and calculation of Admin Plus password .....</b>	<b>146</b>
<b>Verification of ground leakage .....</b>	<b>149</b>
Behaviour of a system without leakage .....	149
Behaviour of a system with leakage .....	150
<b>Measuring the insulation resistance of photovoltaic generator .....</b>	<b>151</b>
<b>Storage and dismantling .....</b>	<b>152</b>
Storage of the equipment or prolonged stop .....	152
Dismantling, decommissioning and disposal.....	152
<b><i>Attachments</i> .....</b>	<b>153</b>
<b>Port and network services used by the inverter.....</b>	<b>153</b>
IP Network Services.....	153
Network Hosts.....	154
Inverter network configuration .....	154
<b>Contact us .....</b>	<b>156</b>



## Reference number index

01 REACT2-UNO wall bracket	31 Coin cell
02 REACT2-UNO	32 DC input terminal
03 Synoptic	33 Memory card
04 heat sink	34 RS485-METER communication card
05 REACT2-UNO front cover	35 RS485-PC communication card
06 Input connectors MPPT1 (IN1)	36 RS485-LOGGER communication card
07 DC and battery disconnect switch	37 RS485-LOGGER line termination switch
08 Battery communication connector COMM.[A]	38 RS485-PC line termination switch
09 Battery power connector POWER [A]	39 RS485-METER line termination switch
10 REACT2-UNO wall attachment point	40 Communication and control signal screw terminal block
11 REACT2-UNO external protective earth	41 Multifunctional relay screw terminal block
12 Input connectors MPPT2 (IN2)	42 AC output (BACKUP) screw terminal block
13 Service cable gland	43 AC output (GRID) screw terminal block
14 METER connector	44 Cable conduit
15 Wi-Fi antenna connector	50 Meter FIMER B21
16 AC output (BACKUP) cable gland	51 REACT-MTR-1PH
17 AC output (GRID) connector	52 Hole for line cable
20 REACT2-BATT wall bracket	53 AC power supply terminal block
21 REACT2-BATT	54 METER RS485 screw terminal block
22 Battery communication connector COMM.[B]	55 METER FIMER B23, B24
23 Battery power connector POWER [B]	56 Inverter and loads side screw terminal block (B23,B24 meter)
24 REACT2-BATT external protective earth [B]	57 METER RS485 screw terminal block
25 REACT2-BATT external protective earth [A]	58 Grid side screw terminal block (B23,B24 meter)
26 REACT2-BATT wall attachment point	59 Grid side screw terminal block (B21 meter)
30 LAN Ethernet connector (RJ45)	60 Inverter and loads side screw terminal block (B21 meter)

## Graphical representation of references

### REACT2-UNO-3.6/5.0-TL (external view)

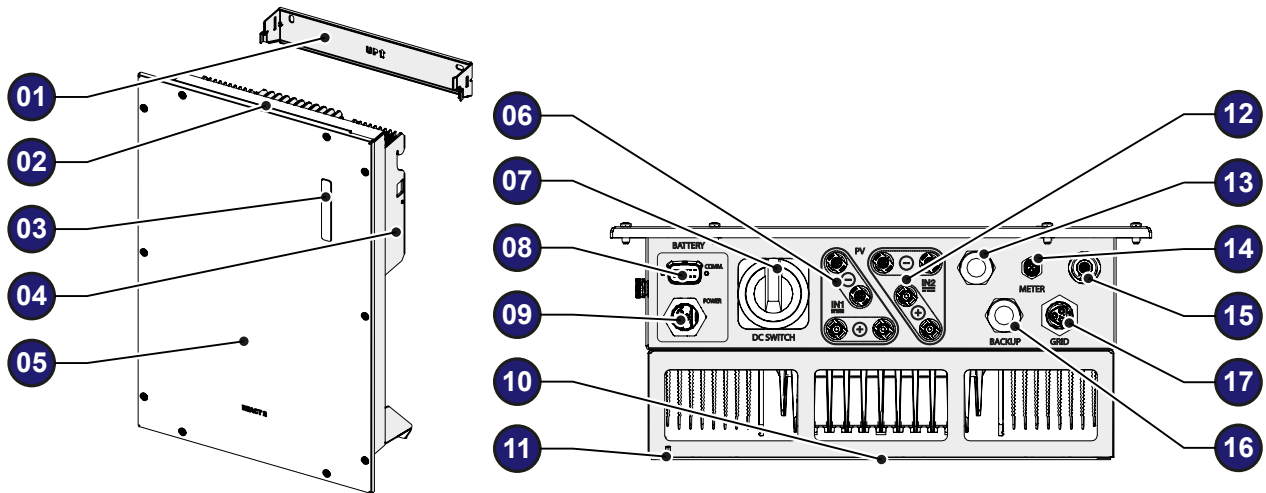

### REACT2-BATT (external view)

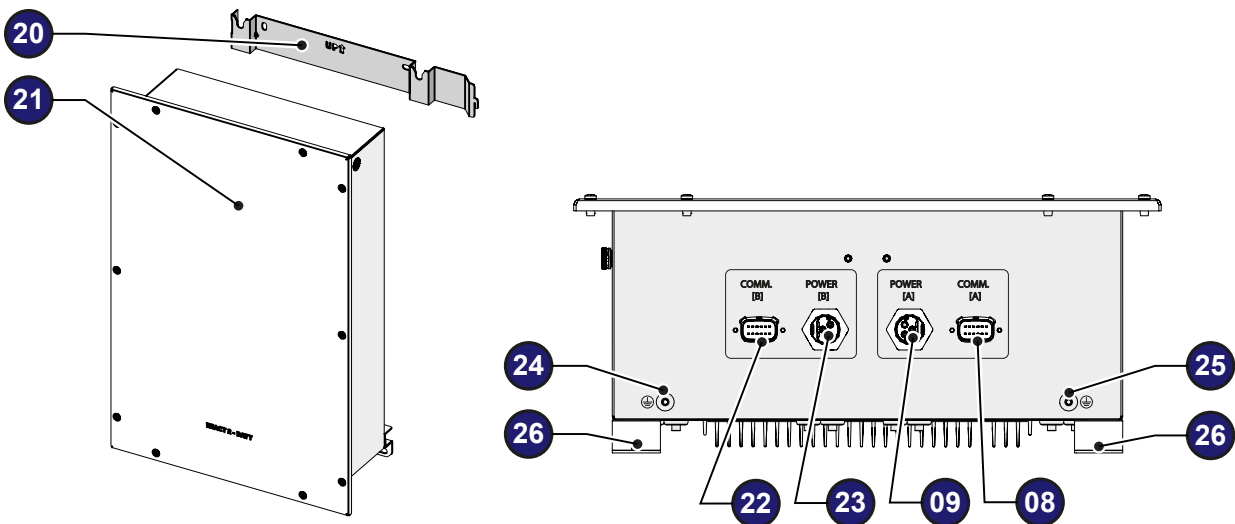

# REACT2-UNO-3.6/5.0-TL (internal view)

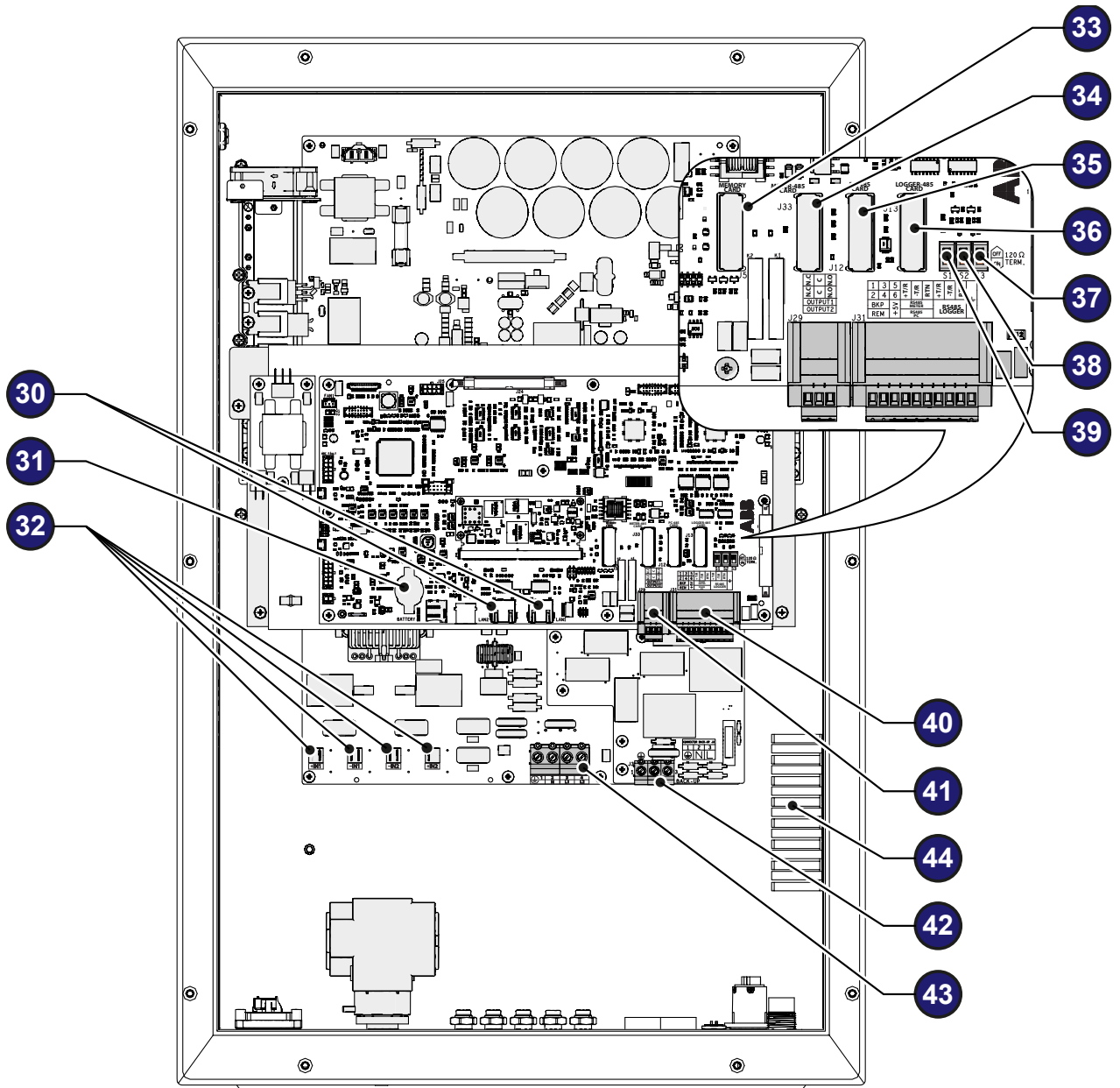

### REACT-MTR-1PH

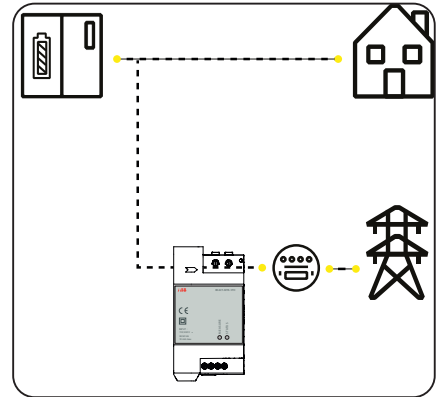
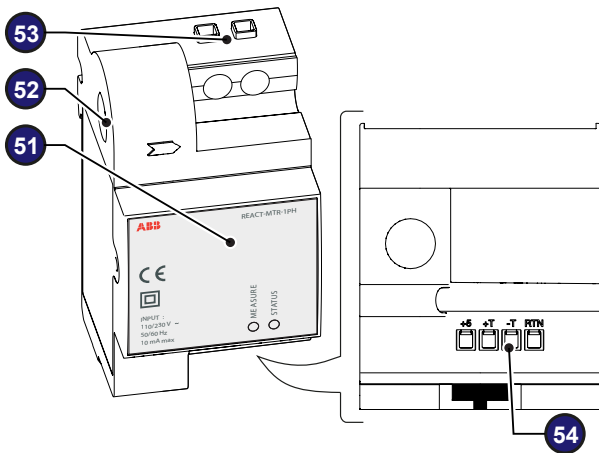

### Meter FIMER B21

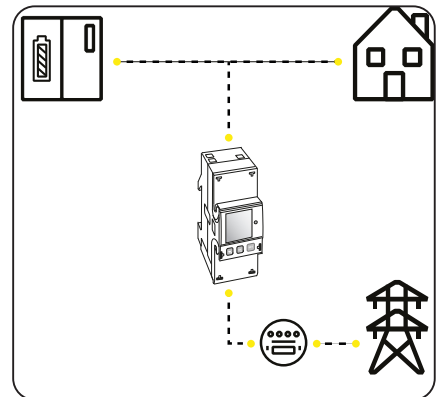
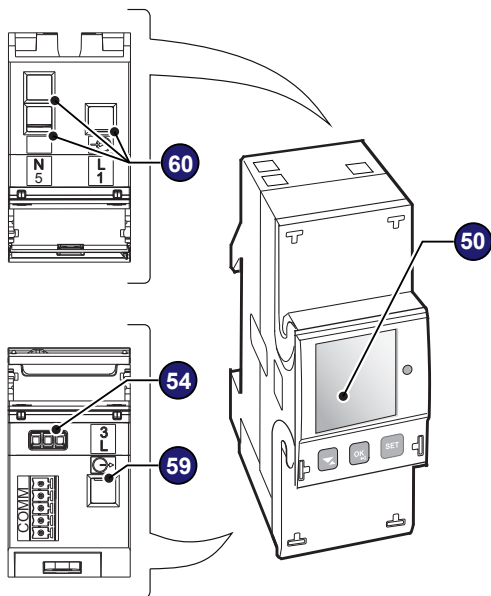

### Meter B23, B24

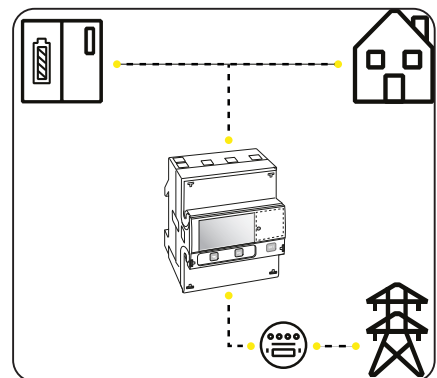
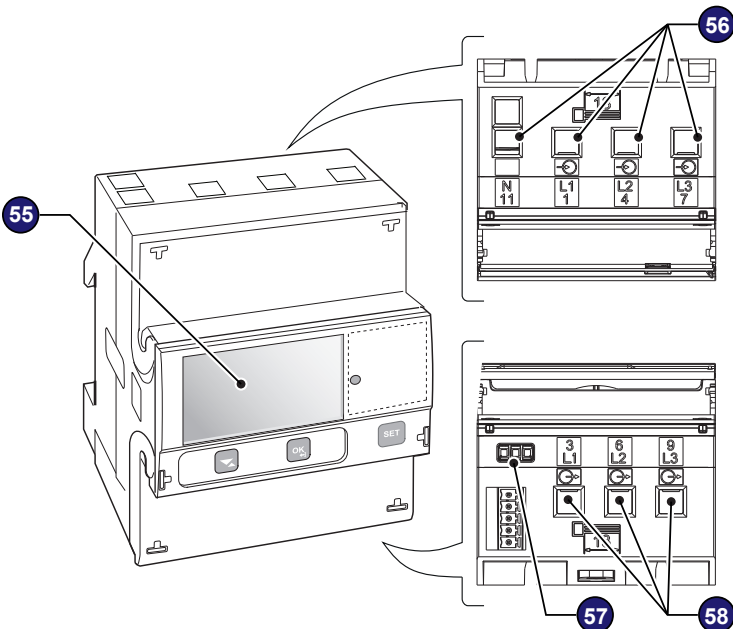

## Scope and target audience

### Purpose and document structure

This operating and maintenance manual is a useful guide that will enable you to work safely and carry out the operations necessary for keeping the equipment in good working order.



*If the equipment is used in a manner not specified in this manual, the protection provided by the equipment may be impaired.*



*The language in which the document was originally written is ITALIAN; therefore, in the event of inconsistencies or doubts please ask the manufacturer for the original document.*

### List of appendix documents

In addition to this user manual and maintenance you can consult (and download) the product documentation by visiting [www.fimercom](http://www.fimercom).

*Part of the information given in this document is taken from the original supplier documents. This document contains only the information considered necessary for the use and routine maintenance of the equipment.*



### Operator and maintenance personnel skills/prerequisites

*Personnel in charge of using and maintaining the equipment must be skilled for the described tasks and must reliably demonstrate their capacity to correctly interpret what is described in the manual.*



*For safety reasons, only a qualified electrician who has received training and/or demonstrated skills and knowledge of the inverter's structure and operation may install the inverter.*



*The installation must be performed by qualified installers and/or licensed electricians in accordance with the existing regulations in the country of installation.*



*Inverter operation and maintenance by a person who is NOT qualified, is intoxicated, or on narcotics, is strictly forbidden.*











*The customer has civil liability for the qualification and mental or physical state of the personnel who interact with the equipment. They must always use the personal protective equipment (PPE) required by the laws of the country of destination and whatever is provided by their employer.*



## Symbols and signs

In the manual and/or in some cases on the equipment, the danger or hazard zones are indicated with signs, labels, symbols or icons.

Symbol	Description
	Indicates that it is mandatory to consult the manual or original document, which must be available for future use and must not be damaged in any way.
	<b>General warning</b> - Important safety information. Indicates operations or situations in which staff must be very careful.
	<b>Dangerous Voltage</b> - Indicates operations or situations in which staff must be very careful with regard to dangerous voltage levels.
	<b>Hot parts</b> - Indicates a risk arising from the presence of hot zones or zones with parts at high temperatures (risk of burns).
	Risk of explosion
	Risk of injury due to the weight of the equipment. Take care during lifting and transport
	Indicates that the area in question must not be accessed or that the operation described must not be carried out.
	Keep out of the reach of children
	Indicates that smoking and the use of naked flames is prohibited.
	Indicates that it is mandatory to carry out the described operations using the clothing and/or personal protective equipment provided by the employer.
	WEEE logo. Indicates that the product is to be disposed of according to current legislation regarding the disposal of electronic components.
	Indicates the protection rating of the equipment according to IEC 70-1 (EN 60529 June 1997) standard.
	Point of connection for grounding protection.
	Indicates the permitted temperature range

Symbol	Description
	Risk of electric shock. The discharge time (quantified in the figure by the number XX) of the stored energy after de-energizing of the Inverter from both DC side and AC side. Warning! Refer to the dedicated procedures in the Instruction Manual before accessing to active parts inside the Inverter.
	Direct Current
	Alternate current
	With isolation transformer
	Without isolation transformer
	Positive pole of the input voltage (DC)
	Negative pole of the input voltage (DC)
	Indicates the centre of gravity of the equipment.
	Indicates the requirement to wear acoustic protection devices in order to prevent damage to hearing

## Field of use, general conditions

FIMER accepts no liability for damage of any kind that may arise from incorrect or careless operations.



*You may not use the equipment for a use that does not conform to that provided for in the field of use. The equipment **MUST NOT** be used by inexperienced staff, or even experienced staff if carrying out operations on the equipment that fail to comply with the indications in this manual and enclosed documentation.*

### Intended or allowed use

The **REACT2** system is designed to optimise self-consumption in residential contexts and consists of

- **REACT2-UNO-3.6/5.0** transforms a direct current (DC) from a photovoltaic generator (FV) into an alternating current (AC) which can be fed into the public distribution grid.
- **REACT2-BATT (battery unit)** temporarily stores unused energy from the photovoltaic generator which will subsequently be used when the energy demand from users is greater than the energy produced by the PV generator
- **Energy meter** which measures energy at the connection point to the grid and communicates with REACT2 in order to maximise energy self-sufficiency by managing the storage system.

### Limits in field of use

---

*The REACT2 system can be used only with photovoltaic modules which do not require the grounding of one of the input poles, unless accessories are installed which are compatible with the inverter and enable this operation to be carried out. In this case you must install an isolation transformer on the AC side of the system.*

---

*Only a photovoltaic generator consisting of class II modules (in accordance with IEC 61730) can be connected as input to the REACT2 system (do not connect batteries or other power sources)*

---

*The REACT2 system can be connected to the electricity grid only in countries for which it has been certified/approved.*

---

*The REACT2 system cannot be connected on the DC side in parallel to other inverters to convert energy from a photovoltaic generator with a power greater than the nominal power of the single inverter.*

---

*The REACT2 system can be used only if all the technical characteristics are observed.*

---

*Batteries other than those approved by FIMER cannot be connected to the REACT2 system*

---



## Improper or disallowed use



IT IS STRICTLY FORBIDDEN TO:

- Install the system in such a way that it is exposed to direct sunlight
- Install the equipment in environments with particular flammability conditions or in environmental conditions (temperature and humidity) other than those specified.
- Use the equipment with safety devices which are faulty or disabled.
- Use the equipment or parts of the equipment by linking it to other machines or equipment, unless expressly provided for.
- Modify operating parameters that are not accessible to the operator and/or parts of the equipment to vary its performance or change its insulation.
- Clean the equipment with corrosive products that may attack parts or generate electrostatic charges.
- Use or install the appliance or parts of it without having read and understood the contents of the user and maintenance manual.
- Warm or dry rags and clothes on parts at temperature. In addition to being hazardous, doing so would compromise component ventilation and cooling.



*For further information on the installation conditions refer to chapter 5 “Installation”*

### General conditions

A description of the equipment characteristics is provided to identify its main components and specify the technical terminology used in the manual.

This chapter contains information about the models, details of the equipment, characteristics and technical data, overall dimensions and equipment identification.



*The customer/Installer takes full responsibility if, when reading this manual, the chronological order of its presentation provided is not observed. All information is provided considering occasional inclusion of information in previous chapters.*



In certain cases, there may be a need to separately document software functionality or attach supplementary documentation to this manual which is intended for more qualified professionals.

## Models and range of equipment

The pieces of equipment which make up the REACT2 system to which this manual is dedicated are:

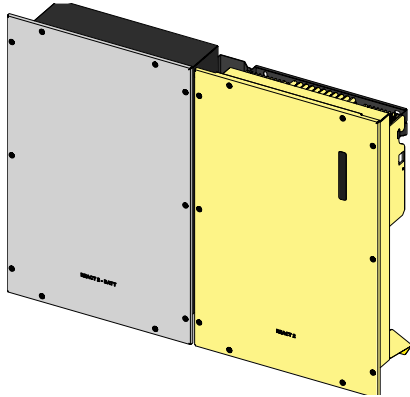

### Single-phase inverter unit:

**REACT2-UNO-3.6-TL** single-phase, maximum output power 3600W

**REACT2-UNO-5.0-TL** single-phase, maximum output power 5000W

Main characteristics

- Number of input channels: 2
- Input connectors: quick fit connectors (2 pairs for each channel)
- DC disconnect switch
- Wireless or LAN communication
- Management of external loads through 2 integrated relays
- AC Backup Output (off grid)

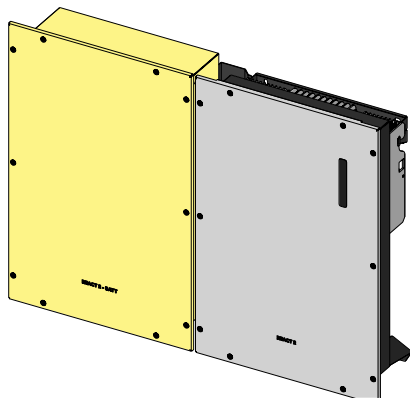

### Battery unit:

**REACT2-BATT** nominal battery capacity 4kWh

In the system up to three REACT2-BATTs can be used (maximum capacity of the system 3x4kWh=12kWh)

### Energy meter:

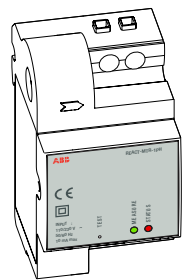

**REACT-MTR-1PH** energy meter for single-phase line

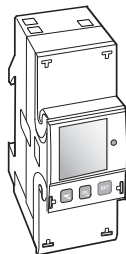

**FIMER B21-212** energy meter for single-phase line

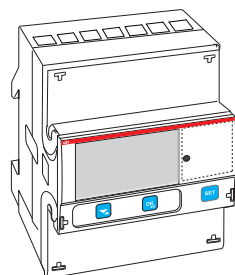

**FIMER B23-212, B24-212** energy meter for three-phase line



*The choice of the components for the system must be made by a qualified technician who knows about the installation conditions, the devices that will be installed outside the inverter and possible integration with an existing system.*

## Identification of the equipment and manufacturer

The technical data provided in this manual does not substitute the data supplied on the labels affixed to the equipment.



The labels affixed to the equipment must NOT be removed, damaged, stained, hidden, etc., for any reason whatsoever.

The approval label contains the following information:

1. Manufacturer
2. Model
3. Rating data
4. Certification marks

**1** **ABB** **4** Made in Italy  
PROTECTIVE CLASS: I

**BATTERY UNIT** MODEL: REACT2-BATT **2**

V <sub>dc</sub> max	575 V
V <sub>dc</sub> operating range	170 - 575 V
I <sub>dc</sub> max (charge)	4.5 A
I <sub>dc</sub> max (discharge)	5.6 A
Whr	4.0 kWh

**3**

-20 to +55 °C (\*)  
-4 to +131 °F (\*)

IP54

**WARNING!**

- Refer to instruction manual for proper installation.
- Do not remove the cover. No user serviceable parts inside.
- Do not expose the unit to heating sources.
- Do not expose the unit to direct solar irradiation.
- Do not install or operate the unit in potentially explosive atmosphere.

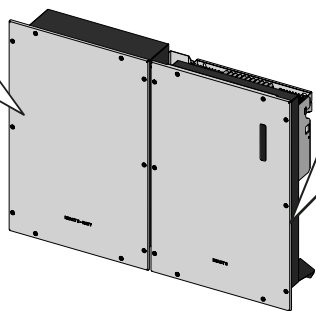

**1** **ABB** **4** Made in Italy  
PROTECTIVE CLASS: I

**SOLARINVERTER** MODEL: REACT2-UNO-3.6-TL **2**

V <sub>dc</sub> max	575 V	V <sub>acr</sub>	230 V 1Ø
V <sub>dc</sub> Operating Range	90 - 575 V	f <sub>r</sub>	50 Hz
V <sub>dc</sub> MPP	160 - 480 V	P <sub>acr</sub> (cos φ=1)	3600 W
I <sub>dc</sub> max	2 x 12 A	P <sub>acr</sub> max	3600 W
I <sub>sc</sub> max	2 x 15 A	P <sub>acr</sub> (cos φ=±0.9)	3200 W
		S <sub>max</sub>	3600 VA
		Adj. cosφ	0.1-1 <sup>III</sup>
		I <sub>acr</sub> max	16 A

(1): Over/Under excited **3**

BATTERY PORT		BACKUP OUTPUT	
V <sub>dc</sub> Operating Range	170 - 575 V	V <sub>acr</sub>	230 V 1Ø
I <sub>dc</sub> max (charge)	13.5 A	f <sub>r</sub>	50 Hz
I <sub>dc</sub> max (discharge)	10 A	I <sub>acr</sub> max	13 A
		S <sub>acr</sub>	3000 VA

**PROTECTIVE EARTHING REQUIRED**

-20 to + 55 °C  
-4 to +131 °F

IP65

**1** **ABB** **4** Made in Italy  
PROTECTIVE CLASS: I

**SOLARINVERTER** MODEL: REACT2-UNO-5.0-TL **2**

V <sub>dc</sub> max	575 V	V <sub>acr</sub>	230 V 1Ø
V <sub>dc</sub> Operating Range	90 - 575 V	f <sub>r</sub>	50 Hz
V <sub>dc</sub> MPP	195 - 480 V	P <sub>acr</sub> (cos φ=1)	5000 W
I <sub>dc</sub> max	2 x 13.5 A	P <sub>acr</sub> max	5000 W
I <sub>sc</sub> max	2 x 15 A	P <sub>acr</sub> (cos φ=±0.9)	4500 W
		S <sub>max</sub>	5000 VA
		Adj. cosφ	0.1-1 <sup>III</sup>
		I <sub>acr</sub> max	22 A

(1): Over/Under excited **3**

BATTERY PORT		BACKUP OUTPUT	
V <sub>dc</sub> Operating Range	170 - 575 V	V <sub>acr</sub>	230 V 1Ø
I <sub>dc</sub> max (charge)	13.5 A	f <sub>r</sub>	50 Hz
I <sub>dc</sub> max (discharge)	14 A	I <sub>acr</sub> max	13 A
		S <sub>acr</sub>	3000 VA

**PROTECTIVE EARTHING REQUIRED**

-20 to + 55 °C  
-4 to +131 °F

IP65



The labels are NOT to be hidden by foreign objects and parts (rags, boxes, equipment, etc.); they must be regularly cleaned and always kept in sight.

In addition to the label showing the inverter data, on the right side of REACT2-UNO there is an additional identification label. The label displays the following information:

The diagram shows a rectangular label with the following fields and callouts:

- MODEL NAME**: Callout to the top left text.
- Inverter model**: Callout to the top left text.
- Inverter Part Number**: Callout to the P/N: P/P/P/P/P/P/P/P field.
- Inverter Serial Number** consisting of:
  - YY = Year of manufacture
  - WW = Week of manufacture
  - SSSSSS = sequential number
 Callout to the SN: YYWWSSSSSS field.
- Week/Year of manufacture**: Callout to the WK: WWYY field.
- Manufacturer**: Callout to the bottom text: POWER-ONE ITALY S.p.A. Via S.Giorgio 642, Terranuova Bracciolini (AR), 52028, Italia.



The officially required information is located on the approval label. The identification label is an accessory label which shows the information necessary for the identification and characterisation of the inverter by FIMER.



The labels are NOT to be hidden by foreign objects and parts (rags, boxes, equipment, etc.); they must be regularly cleaned and always kept in sight.

### Communication identification label

An additional Communication Identification label is applied on the REACT2-UNO. The label displays the following information:

The diagram shows a rectangular label divided by a dashed line. The top part contains:

- SN WLAN: SSSSSSSSS**: Callout to the top left text.
- WLAN embedded board Serial Number**: Callout to the top left text.
- PN WLAN: PPP.PPPPP.PP**: Callout to the middle left text.
- WLAN embedded board Part Number**: Callout to the middle left text.
- MAC address:**
  - To be used to obtain the SSID of the wireless access point created by the inverter: **ABB-XX-XX-XX-XX-XX-XX** (where "X" is a hex digit of the MAC address).
  - To be used to obtain the "Host Name": **http://ABB-XX-XX-XX-XX-XX-XX.local** (where "X" is a hex digit of the MAC address).
  - MAC address it's the only required information to register the inverter with Aurora Vision.
 Callout to the MAC: XX:XX:XX:XX:XX:XX field.

The bottom part contains:

- Inverter Serial Number**: Callout to the SN Inverter: SSSSSSSSS field.
- Product Key:**
  - To be used as wireless access point password, or to be used to access to the Web UI as username and password in case of lost credentials, and to commission inverter using FIMER Installer for Solar Inverters.
 Callout to the PK: KKKK-KKKK-KKKK-KKKK field.

Additional features on the label include a QR code, a small icon of a smartphone, and the text: "Remove and apply on the Quick installation guide".



The Communication Identification label is divided in two separate parts by a dashed line; take the bottom part and apply it on the plant documentation. (it's recommend to create a plant map and apply the Communication Identification label of each inverters in the right position of that map).

## Characteristics and technical data

System components of REACT2 photovoltaic system with storage	REACT2-3.6-TL-OUTD	REACT2-5.0-TL-OUTD
Inverter unit	REACT2-UNO-3.6-TL	REACT2-UNO-5.0-TL
Battery unit	REACT2-BATT	
Energy meter	REACT-MTR-1PH; FIMER B21-212; FIMER B23-212; FIMER B24-212	

Inverter	REACT2-UNO-3.6-TL	REACT2-UNO-5.0-TL
<b>PV port</b>		
Absolute maximum DC input voltage (V <sub>dc</sub> , max)	575 V	
Start-up DC input voltage (V <sub>start</sub> )	200 V (adj. 120...350 V)	
Operating DC input voltage range (V <sub>dcmin</sub> ...V <sub>dcmax</sub> )	0.7 x V <sub>start</sub> ...575 V (min 90 V)	
Rated DC input voltage (V <sub>dcr</sub> )	390 V	
Rated DC input power (P <sub>dcr</sub> )	5000 W	6000 W
Number of Independent MPPT	2	
Maximum DC input power for each MPPT (P <sub>MPPTmax</sub> )	2500W Linear derating [480 V ≤ V <sub>MPPT</sub> ≤ 575 V]	3000W Linear derating [480 V ≤ V <sub>MPPT</sub> ≤ 575 V]
DC input voltage range with parallel configuration of MPPT at P <sub>acr</sub> , not operative battery	160 V...480 V	195 V...480 V
Maximum DC input current (I <sub>dc</sub> max) / for each MPPT (I <sub>MPPTmax</sub> )	24 A / 12 A	27 A / 13.5 A
Maximum input short circuit current for each MPPT (I <sub>scmax</sub> )	15 A	
Maximum Return current (AC side vs DC side)	Negligible in normal operating conditions <sup>(6)</sup>	
Number of DC input connection pairs for each MPPT	2	
DC connection type	Quick-fit PV connector <sup>(1)</sup>	
<b>PV port protection</b>		
Reverse polarity protection	Yes, from current limited source	
Input overvoltage protection for each MPPT - varistor	Yes	
Photovoltaic array isolation control	According to local standard	
DC switch rating for each MPPT	25 A / 575 V	
<b>Output AC port</b>		
AC grid connection type	Single-phase	
Rated AC power (P <sub>acr</sub> @cosφ=1)	3600 W	5000 W <sup>(2)</sup>
Maximum AC output power (P <sub>acmax</sub> @cosφ=1)	3600 W	5000 W <sup>(2)</sup>
Maximum apparent power (S <sub>max</sub> )	3600 VA	5000 VA <sup>(2)</sup>
Rated AC grid voltage (V <sub>ac,r</sub> )	230 V	
AC voltage range	180...264 V <sup>(3)</sup>	
Maximum AC output current (I <sub>ac</sub> ,max)	16 A	22 A
Contributory fault current	16A	22A
Inrush current	Negligible	
Rated output frequency (f <sub>r</sub> )	50 Hz / 60 Hz	
Output frequency range (f <sub>min</sub> ...f <sub>max</sub> )	45...55 Hz / 55...65 Hz <sup>(4)</sup>	
Nominal power factor and adjustable range	> 0.995, adj. ± 0.1 - 1 (over/under excited)	
Total current harmonic distortion	<3%	
AC connections type	Panel connector	
<b>Output AC port protection</b>		
Anti-islanding protection	According to local standard	
Maximum external AC overcurrent protection	20 A	25 A
Output overvoltage protection - varistor	2 (L - N / L - PE)	
<b>Backup output port</b>		
AC grid connection type	Single-phase	
Maximum apparent power (S <sub>max</sub> )	3000 VA	
Rated AC grid Voltage (V <sub>acr</sub> )	230 V	
AC Voltage range	180...264 V <sup>(3)</sup>	
Maximum AC output current (I <sub>ac</sub> max)	13 A	
Rated output frequency (f <sub>r</sub> )	50 Hz / 60 Hz	
Output frequency range (f <sub>min</sub> ...f <sub>max</sub> )	45...55 Hz / 55...65 Hz <sup>(4)</sup>	

Inverter	REACT2-UNO-3.6-TL	REACT2-UNO-5.0-TL
AC connections type	Screw terminal block	
<b>Backup output protection</b>		
Maximum external AC overcurrent protection	16 A	
Output overvoltage protection - varistor	2 (L-N/L-PE)	
<b>Input AC port</b>		
AC voltage range	230 V	
Maximum AC input current (I <sub>ac max</sub> )	16 A	22 A
Inrush current	Negligible	
Rated output frequency (fr)	50 Hz / 60 Hz	
<b>Battery port</b>		
Operating DC input voltage range (V <sub>dcm in</sub> ...V <sub>dcm ax</sub> )	170 V...575 V	
Maximum DC charge current (I <sub>dc,max charge</sub> )	13.5 A	13.5 A
Rated AC grid Voltage (V <sub>acr</sub> )	10 A	10 A
<b>Operating performance</b>		
Maximum efficiency (η <sub>max</sub> )	97.1%	
Weighted efficiency (EURO/CEC)	96.3% / -	96.6% / -
<b>Embedded communication</b>		
Embedded physical interface	Wireless <sup>(6)</sup> , 2 x Ethernet, RS485	
Embedded communication protocols	Modbus TCP (SunSpec), Modbus RTU (SunSpec), FIMER-free@home <sup>®</sup>	
Datalogger data retention	30 days	
Remote monitoring	Mobile app	
Local monitoring	Web server user interface	
<b>Environmental</b>		
Ambient temperature range	-20...+55°C with derating above 50°C	-20...+55°C with derating above 45°C
Relative humidity	4...100 % condensing	
Acoustic noise emission level	< 50 dB (A) @ 1 m	
Maximum operating altitude without derating	2000 m / 6560 ft	
Environmental pollution degree classification for external environments	3	
Environmental class	Outdoor	
Suitable for wet location	Yes	
<b>Physical</b>		
Environmental protection rating	IP65	
Cooling	Natural	
Dimension (H x W x D)	740 mm x 490 mm x 229 mm	
Weight	< 22 kg	
Mounting system	Wall bracket	
Overvoltage rating as per IEC 62109-1	II (DC input) III (AC output)	
<b>Safety</b>		
Safety class	I	
Insulation level	Transformerless	
Marking	CE <sup>(7)</sup>	
Safety and EMC Standards	IEC/EN 62109-1, IEC/EN 62109-2, EN 61000-6-2, EN 61000-6-3, EN 61000-3-2, EN 61000-3-3, EN61000-3-11, EN61000-3-12	
Grid standard (check your sales channel for availability)	CEI 0-21, DIN V VDE V 0126-1-1, VDE-AR-N 4105, G83/2, G59/3, RD 413, AS/NZS 4777.2,C10/11, IEC 61727, IEC 62116	
<b>Other features</b>		
Load manager	Yes, with two integrated relays	
AC backup output, off grid	Yes	
Battery charge from AC	Yes, it can be enabled	
AC-coupled	Yes	

Battery Unit	REACT2 - BATT								
Modules manufacturer	Samsung								
Battery type	Li-Ion								
Total energy	4 kWh								
Maximum battery voltage (Vdc max)	575 V								
Battery voltage range (Vdc operating range)	170...575 V								
Maximum DC charge current (Idc max charge)	4.5 A for each battery installed								
Maximum DC discharge current (Idc,max discharge)	5.6 A for each battery installed								
Deep of discharge (DoD)	95%								
N° of battery unit that can be connected to the REACT2-UNO inverter	1, 2, 3								
Charge power	1.6 kW (1xREACT2-BATT), 3.2 kW (2xREACT2-BATT), 4.8 kW (3xREACT2-BATT)								
Discharge power	<table border="0"> <tr> <td>REACT2-3.6-TL-OUTD</td> <td>REACT2-5.0-TL-OUTD</td> </tr> <tr> <td>2 kW (1xREACT2-BATT),</td> <td>2 kW (1xREACT2-BATT),</td> </tr> <tr> <td>3.6 kW (2xREACT2-BATT),</td> <td>4 kW (2xREACT2-BATT),</td> </tr> <tr> <td>3.6 kW (3xREACT2-BATT)</td> <td>5 kW (3xREACT2-BATT)</td> </tr> </table>	REACT2-3.6-TL-OUTD	REACT2-5.0-TL-OUTD	2 kW (1xREACT2-BATT),	2 kW (1xREACT2-BATT),	3.6 kW (2xREACT2-BATT),	4 kW (2xREACT2-BATT),	3.6 kW (3xREACT2-BATT)	5 kW (3xREACT2-BATT)
REACT2-3.6-TL-OUTD	REACT2-5.0-TL-OUTD								
2 kW (1xREACT2-BATT),	2 kW (1xREACT2-BATT),								
3.6 kW (2xREACT2-BATT),	4 kW (2xREACT2-BATT),								
3.6 kW (3xREACT2-BATT)	5 kW (3xREACT2-BATT)								

### Environmental

Environmental protection rating	IP54 (suggested indoor installation for preserving battery life time)
Ambient temperature range	-20...+55°C (out of 0...+40°C temperature range, battery will be disabled)
Suggested ambient temperature	+5...+30°C
Storage temperature	-20...+25°C (6 months) or -20...+45°C (3 months)
Relative humidity	4...100 % condensing

### Physical

Cooling	Natural
Dimension (H x W x D)	740 mm x 490 mm x 229 mm
Weight	50 kg
Mounting system	Wall bracket

### Safety

Protective class	I
Marking	CE <sup>(7)</sup>
Safety	IEC 62619, UN38.3, UN3480

### Energy meter

REACT-MTR-1PH	Single-phase, 20A
FIMER B21-212	Single-phase, 65A
FIMER B23-212	Three-phase, 65A
FIMER B24-212	Three-phase with external CT (opt.)

- 1) Refer to the document "String inverter – Product Manual appendix" available at [www.fimer.com](http://www.fimer.com) to know the brand and the model of the quick fit connector"
- 2) For VDE-AR-N 4105 setting, maximum active power of 4600 W and maximum apparent power of 4600 VA
- 3) The AC voltage range may vary depending on specific country grid standard
- 4) The Frequency range may vary depending on specific country grid standard
- 5) As per IEEE 802.11 b/g/n standard
- 6) In the event of a fault, limited by the external protection envisaged on the AC circuit
- 7) Hereby, Power-One Italy S.p.A. (A Member of the FIMER Group) declares that the radio equipments (radio module combined with the inverter), to which this user manual refers, are in compliance with the Directive 2014/53/EU. The full text of the EU Declaration of Conformity is available at the following internet address: [www.fimer.com](http://www.fimer.com)

**Remark. Features not specifically listed in the present data sheet are not included in the product**



## Tightening torques

To maintain the IP65 protection of the system and for optimal installation, the following tightening torques must be used:

<b>REACT2-UNO</b>	
AC output (GRID connector 17 cable gland (ring nut fastening)	<b>4...5 Nm</b>
Service cable glands 13 (M25)	<b>7.0 Nm</b>
Screws for REACT2-UNO front cover 05	<b>2.0 Nm</b>
AC BACKUP output screws terminal block 42 - 4 mm <sup>2</sup> Max	<b>0.6 Nm</b>
Communication and control signal screw terminal block 40 1.5 mm <sup>2</sup> Max	<b>0.25 Nm</b>
REACT2-UNO external protective earth 11	<b>4.1 Nm</b>
Multifunction relay screw terminal block 41 1.5 mm <sup>2</sup> Max	<b>0.25 Nm</b>

<b>REACT2-BATT</b>	
REACT2-BATT external protective earth [A] 25	<b>4.1 Nm</b>
REACT2-BATT external protective earth [B] 24	<b>4.1 Nm</b>

<b>REACT-MTR-1PH (Single phase)</b>	
METER RS485 serial screw terminal block 54 1.5 mm <sup>2</sup> Max	<b>0.5 Nm</b>
AC power supply screw terminal block 53 4 mm <sup>2</sup> Max	<b>0.5 Nm</b>

<b>Meter FIMER B21 (Single phase)</b>	
METER RS485 screw terminal block 54 1.5 mm <sup>2</sup> Max	<b>0.5 Nm</b>
AC power supply screw terminal block 53 4 mm <sup>2</sup> Max	<b>0.5 Nm</b>

<b>Meter FIMER B23, B24 (Three phase)</b>	
METER RS485 screw terminal block 57 - 1 mm <sup>2</sup> Max	<b>0.25 Nm</b>
Three-phase connection screw terminal block 56 - 25 mm <sup>2</sup> Max	<b>4.0 Nm</b>

### Overall dimensions REACT2-3.6/5.0-TL-OUTD

The overall dimensions are expressed in millimetres and include the wall installation bracket.

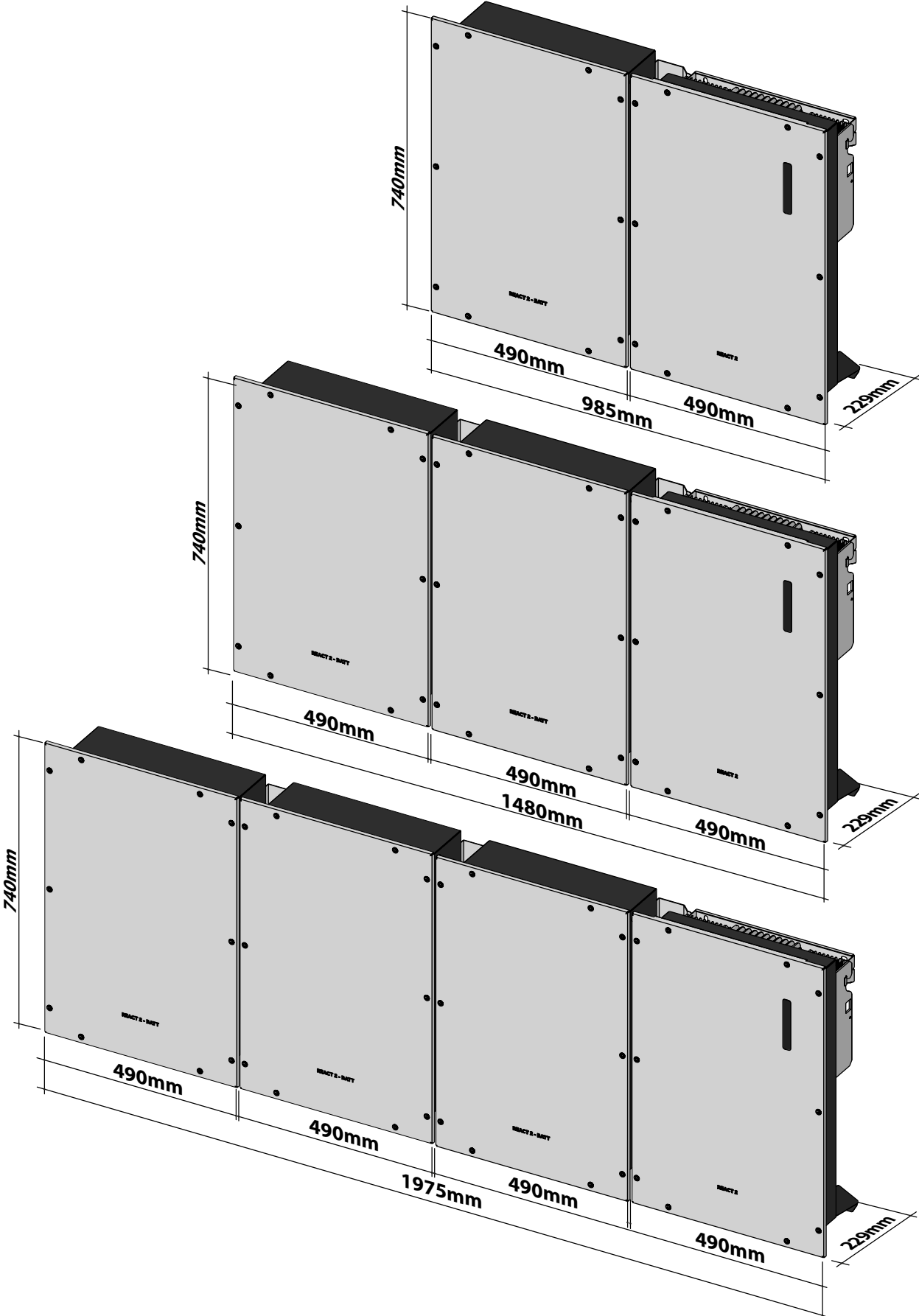

### Overall dimensions REACT-MTR-1PH

The overall dimensions are given in mm.

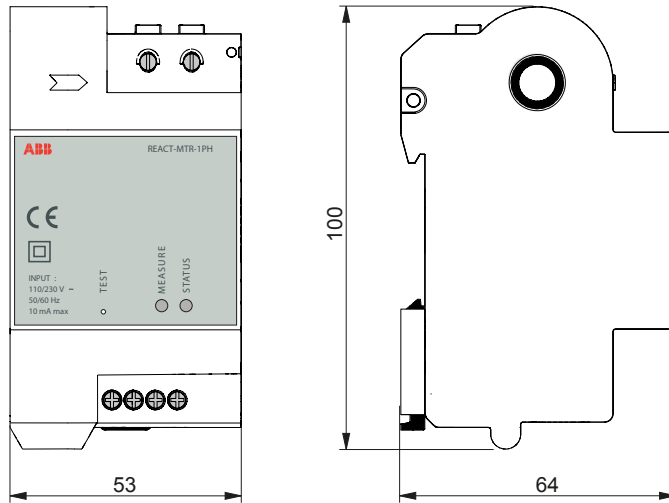

### Overall dimensions Meter FIMER B21

The overall dimensions are given in mm.

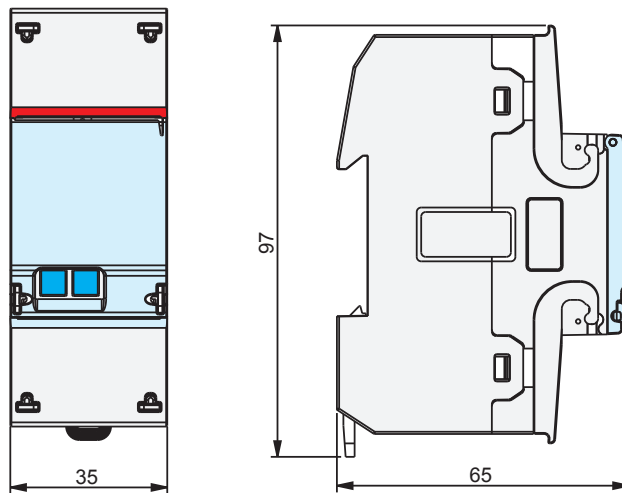

### Overall dimensions Meter FIMER B23, B24

The overall dimensions are given in mm.

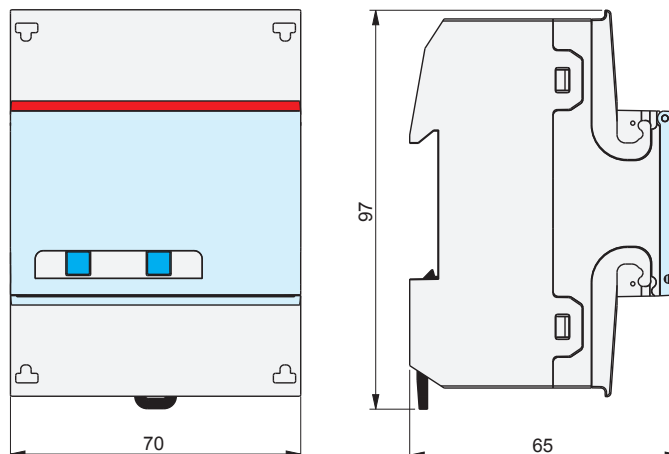

### Dimensions bracket REACT2-UNO-3.6/5.0-TL

The dimensions of the wall mounting bracket are expressed in mm

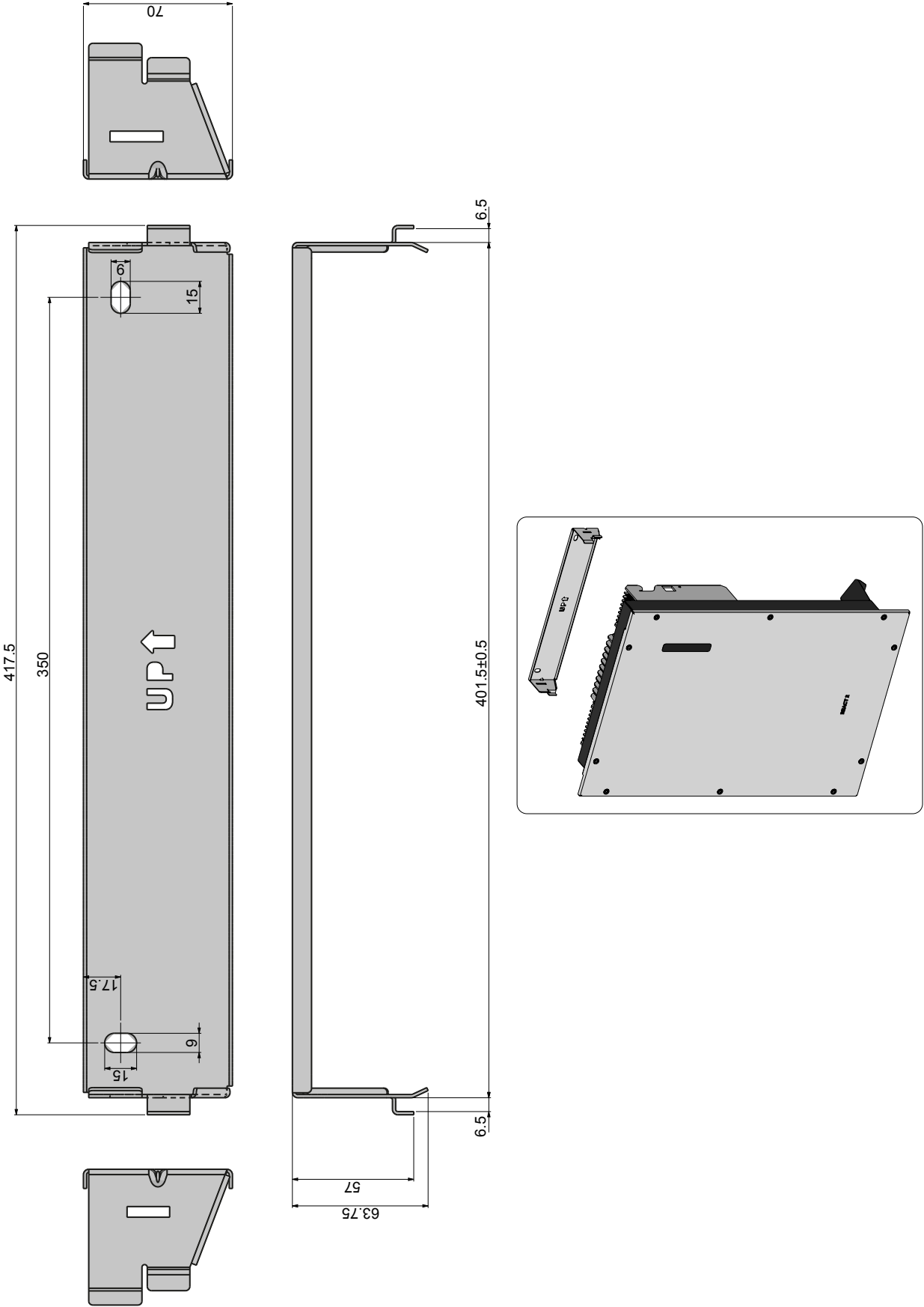

000888AG-F

## Dimensions bracket REACT2-BATT

The dimensions of the wall mounting bracket are expressed in mm

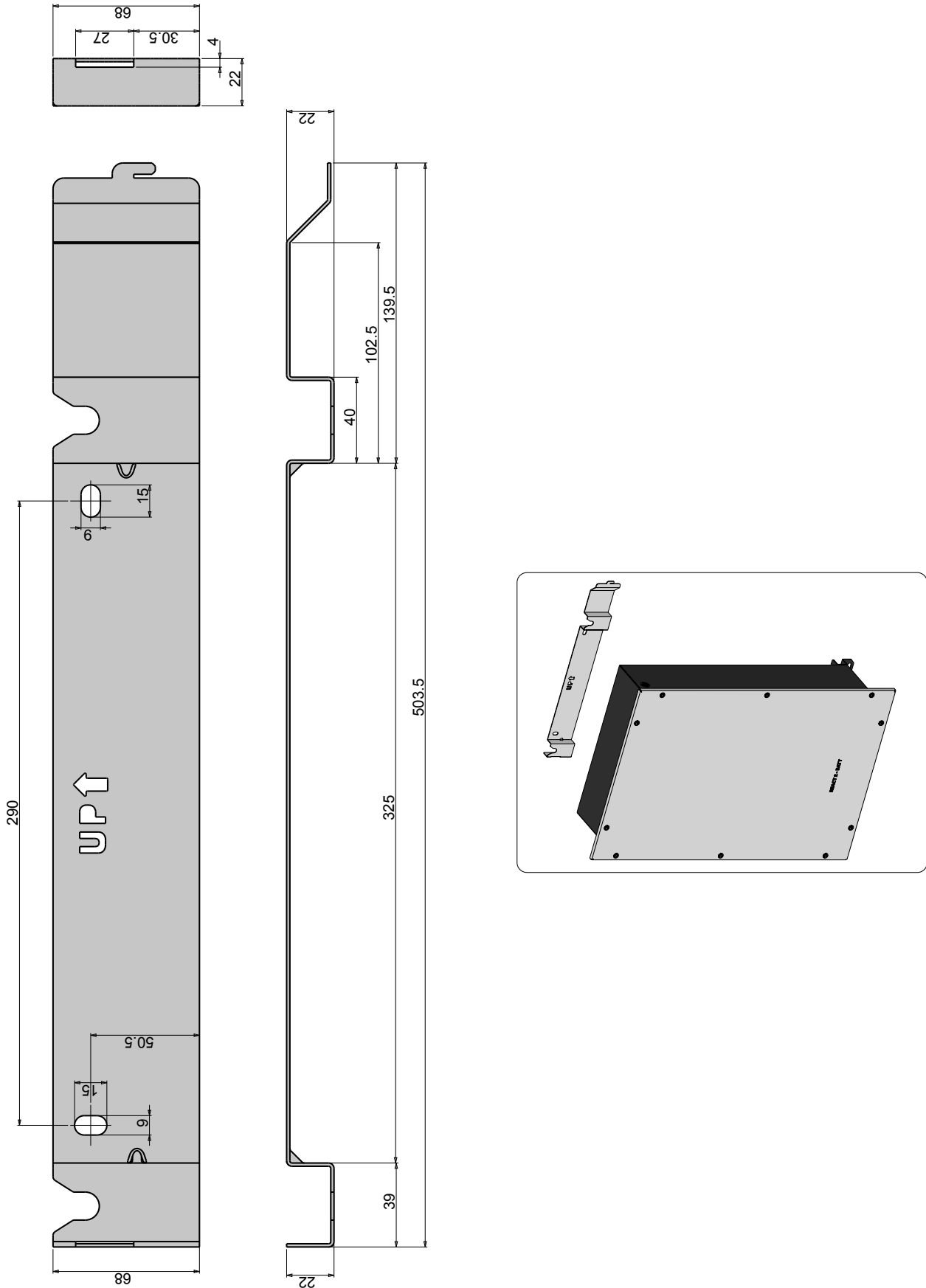

# Efficiency curves

The equipment was designed considering current energy conservation standards, to avoid waste and unnecessary leakage.

Graphs of the efficiency curves of all models of inverter described in this manual are shown below.

*The efficiency curves are linked to technical parameters that are continually being developed and improved and should therefore be considered approximate.*

## REACT2-UNO-3.6-TL

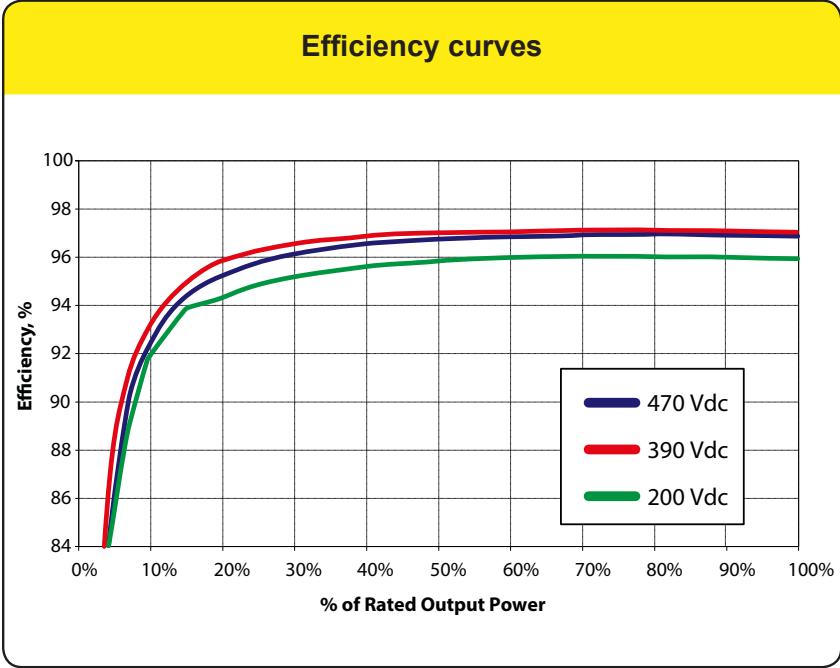

## REACT2-UNO-5.0-TL

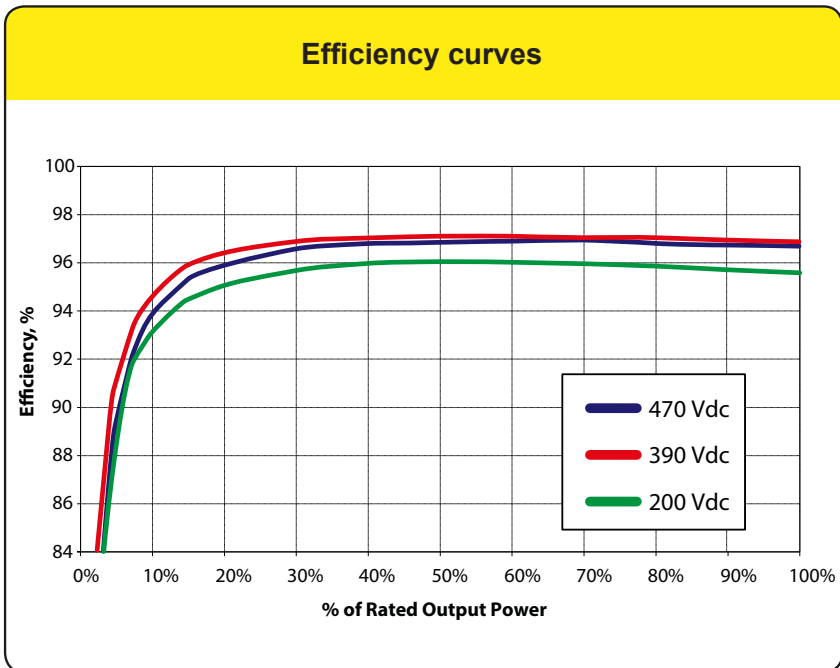

## Power limitation (Power Derating)

In order to allow inverter operation in safe thermal and electrical conditions, the unit automatically reduces the amount of power fed into the grid.

Power limiting may occur due to:

- Adverse environmental conditions (thermal derating)
- Percentage of output power
- Over-frequency of grid voltage
- Grid overvoltage  $U > 10\text{min Der.}$
- Anti-islanding
- Grid undervoltage
- High input voltage values.
- High input current values.

*The aforementioned power limits may vary depending on the grid standard of the country of installation.*

## Power reduction due to environmental conditions

The power reduction value and the inverter temperature at which it occurs depend on the ambient temperature and on many operating parameters. Example: input voltage, grid voltage and power available from the photovoltaic field.

The inverter can therefore reduce the power during certain periods of the day according to the value of these parameters.

In any case, the inverter guarantees the maximum output power even at high temperatures, provided the sun is not shining directly on it.

REACT2-UNO-3.6-TL  
REACT2-UNO-5.0-TL

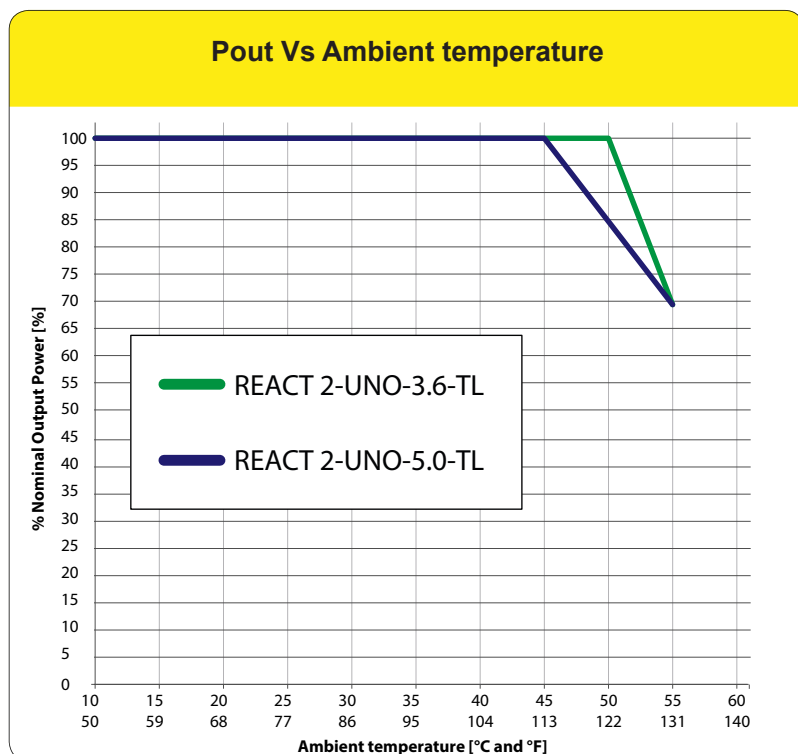

### Power reduction due to the altitude of the installation

The graphs show the automatic reduction of supplied power as a function of the altitude of the installation.

REACT2-UNO-3.6-TL  
REACT2-UNO-5.0-TL

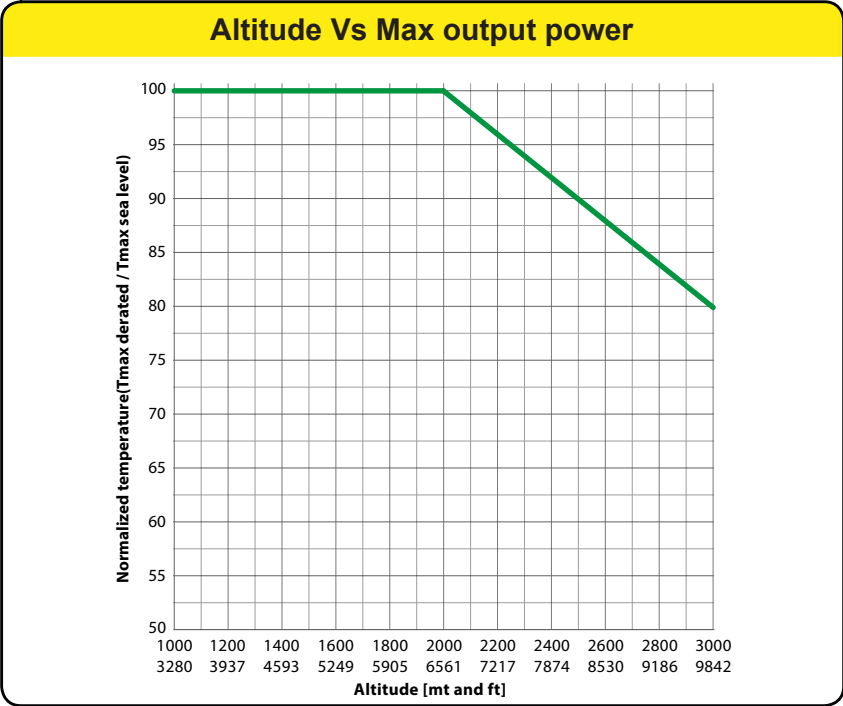

REACT2-UNO-3.6-TL  
REACT2-UNO-5.0-TL

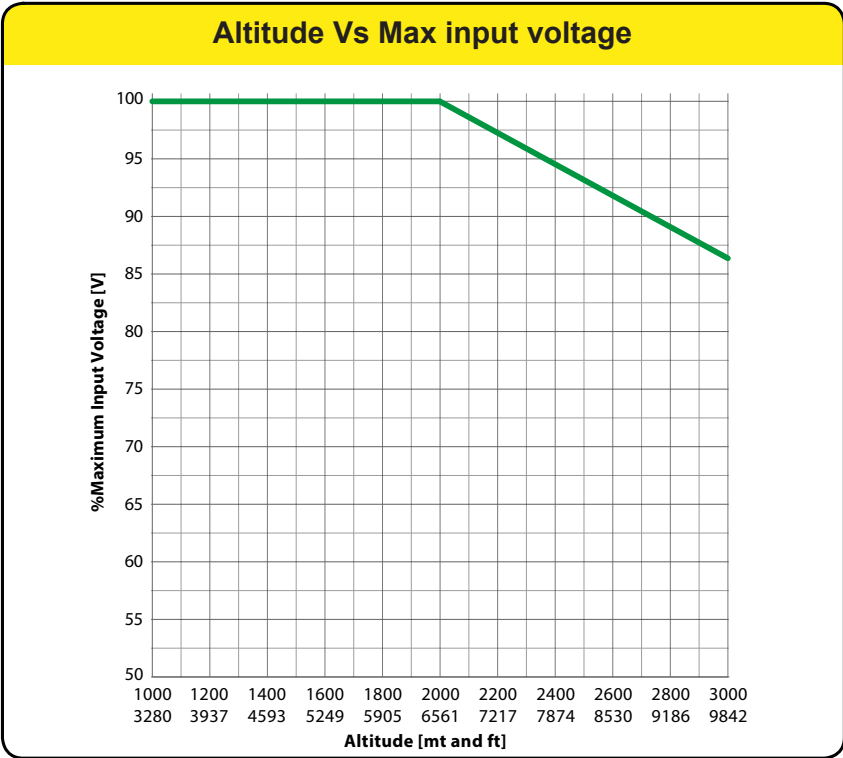



## Output power reduction due to the input voltage

The graphs show the automatic reduction of supplied power when input voltage values are too high or too low.

### REACT2-UNO-3.6-TL

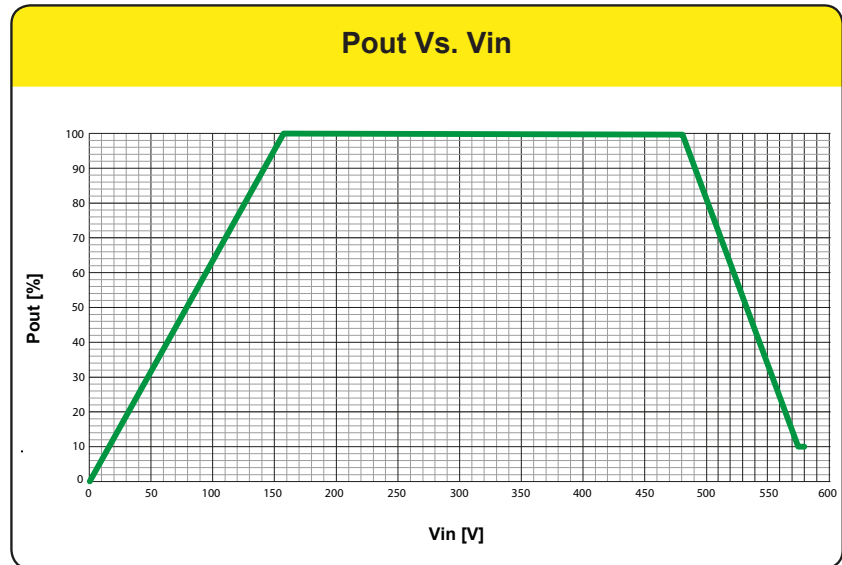

The operating point of REACT2, inside the area of the diagram, depends on the level of charge of the battery/ies, the PV power available and the setting of the control algorithm. For input voltages below 90Vdc, the output power of the inverter could be different from zero should the battery be low.

### REACT2-UNO-5.0-TL

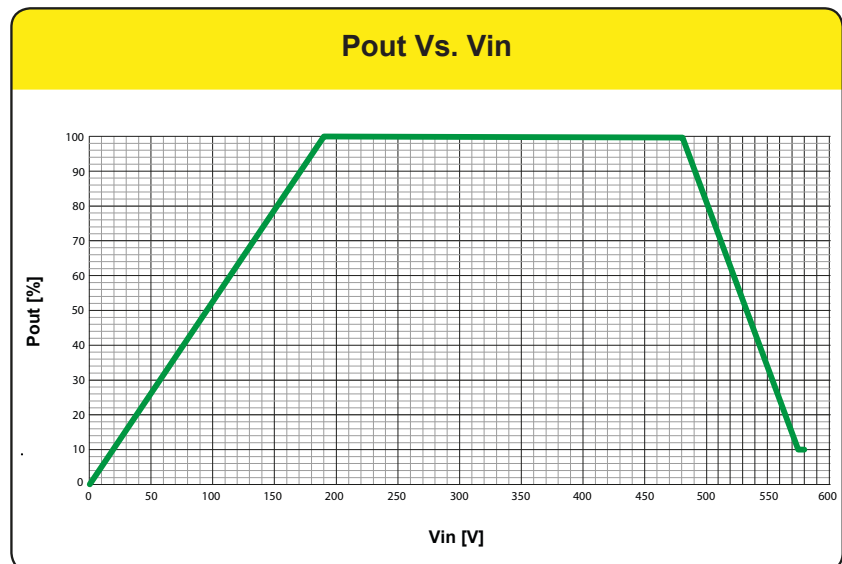

The operating point of REACT2, inside the area of the diagram, depends on the level of charge of the battery/ies, the PV power available and the setting of the control algorithm. For input voltages below 90Vdc, the output power of the inverter could be different from zero should the battery be low.

## Input power reduction due to the input voltage

The graphs show the automatic reduction of supplied power when input voltage values are too high or too low.

### REACT2-UNO-3.6-TL

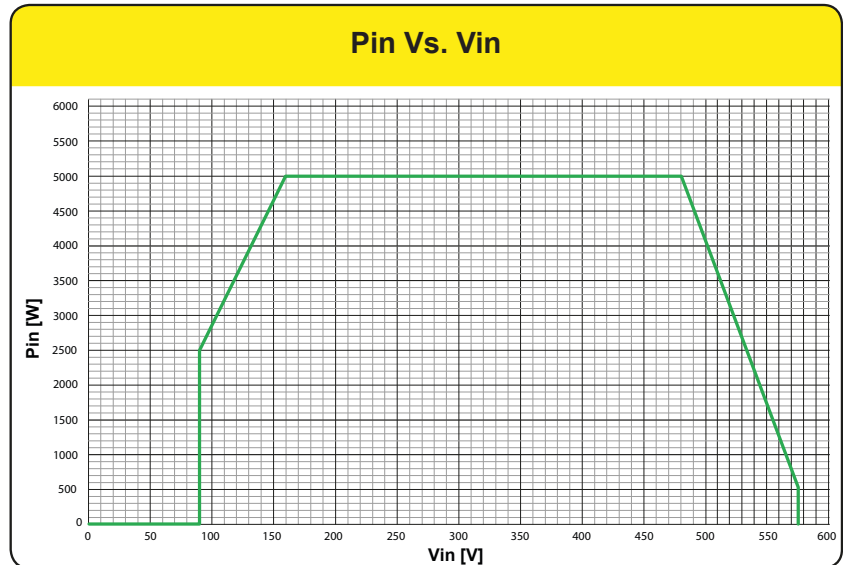

*For input voltages below 90Vdc the batteries can only be charged from the grid, while over 90Vdc the batteries can be charged from the photovoltaic system and/or from the grid at the same time.*

### REACT2-UNO-5.0-TL

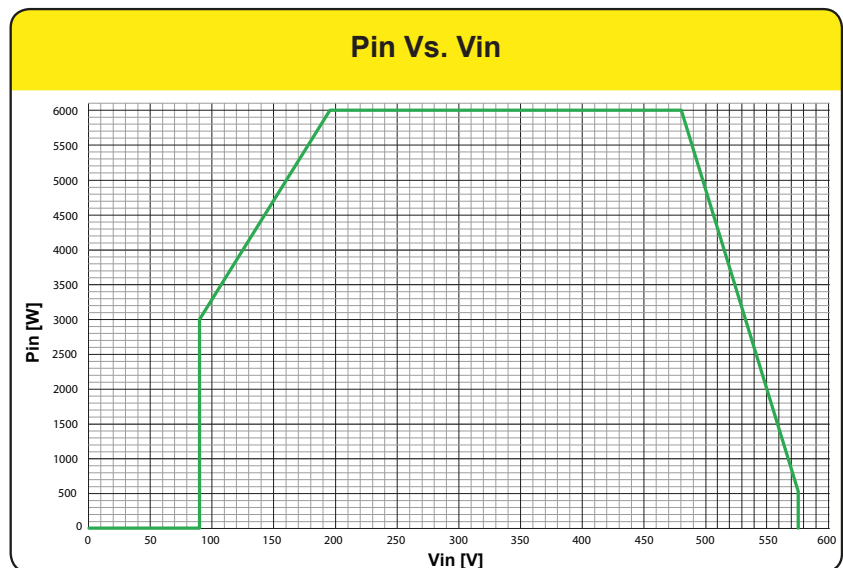

*For input voltages below 90Vdc the batteries can only be charged from the grid, while over 90Vdc the batteries can be charged from the photovoltaic system and/or from the grid at the same time.*

## P- Q curve capability

Based on the country grid standard the P-Q capability curve can be reduced.

Conditions:

### REACT2-UNO-3.6-TL

- Rated output voltage (Un) 230Vac
- Rated active power (Pn) 3600W
- Maximum apparent power (Sn) 3600VA
- Maximum reactive power (Qn) 2200VAR
- Cos -0.1 ... 1 ... +0.1

### REACT2-UNO-5.0-TL

- Rated output voltage (Un) 230Vac
- Rated active power (Pn) 5000W
- Maximum apparent power (Sn) 5000VA
- Maximum reactive power (Qn) 3000VAR
- Cos -0.1 ... 1 ... +0.1

REACT2-UNO-3.6-TL  
REACT2-UNO-5.0-TL

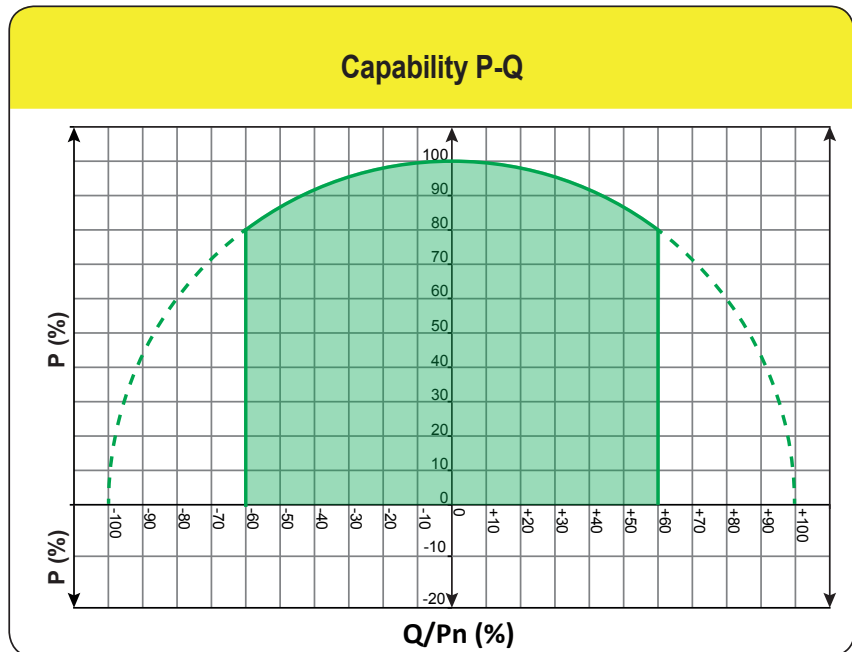

## Characteristics of a photovoltaic generator

A PV generator consists of an assembly of photovoltaic modules that transform solar radiation into DC electrical energy and can be made up of:

**Strings:** number (X) of PV modules connected in series

**Array:** group of X strings connected in parallel

### Strings and Arrays

The string technology was developed to significantly reduce the installation costs of a photovoltaic system, mainly associated to wiring on the DC side of the inverter and subsequent distribution on the AC side. A photovoltaic panel consists of many photovoltaic cells mounted on the same support.

- A string consists of a certain number of panels connected in series.
- An array consists of two or more strings connected in parallel.

Large photovoltaic systems can include multiple arrays connected to one or more inverters.

The greater the number of panels in each string, the lower the cost and the less complex the wiring connections of the system.

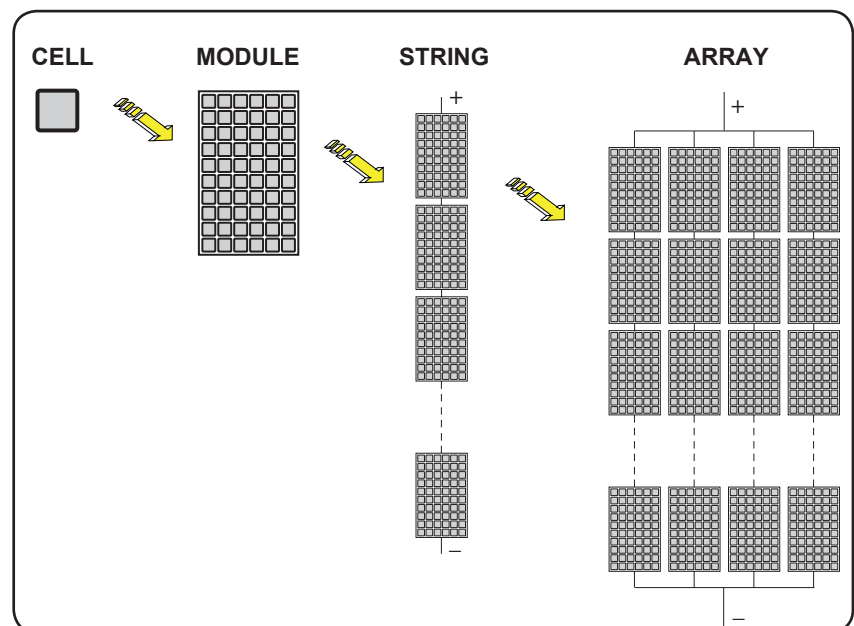

*The current of each array must fall within the limits of the inverter.*

### Description of the REACT2 system

The REACT2 system is designed to optimise self-consumption in residential environments and consists of:

- **REACT2-UNO (inverter)**. It transforms a direct current (DC) from a photovoltaic generator (FV) into an alternating current (AC) which can be fed into the public distribution grid.

In addition, the REACT2-UNO inverter receives data from the FIMER energy meter and performs smart management of energy storage in the REACT2-BATT battery unit in order to maximise self-consumption for domestic utilities.

The configuration and monitoring of the system are made possible by the built-in Wi-Fi/Ethernet logger which enables the sending of the system data to a Wi-Fi/Ethernet router which, in turn, sends the data to the Aurora Vision portal and can be consulted online or through an APP for smartphones/tablets.

- **REACT2-BATT (battery unit)**. It temporarily stores the unused energy from the photovoltaic generator. The energy stored will subsequently be used whenever the demand for energy is greater than that produced by the generator.

- **FIMER energy meter**. It measures the energy at the connection point to the grid and communicates with REACT2 in order to manage the storage system.

Based on of domestic consumption and the level of charge of the batteries it is possible that the maximum limit on active power fed into the grid, set by the operator, may be exceeded; in this case the REACT2 system can automatically limit the feeding of active power into the grid (zero injection).

### Notes on the sizing of the system

Decisions on how to structure a photovoltaic system depend on a series of factors and considerations, such as the type of panels, the available space, the future location of the system, energy production goals over the long term, etc.

*A configuration program that can help to correctly size the photovoltaic system is available on the FIMER website <http://stringsizer.fimer.com>.*

### Operating diagram

#### New installation

REACT 2 is perfect for new installation because it is a PV inverter with an integrated battery allowing simpler installation and best performances

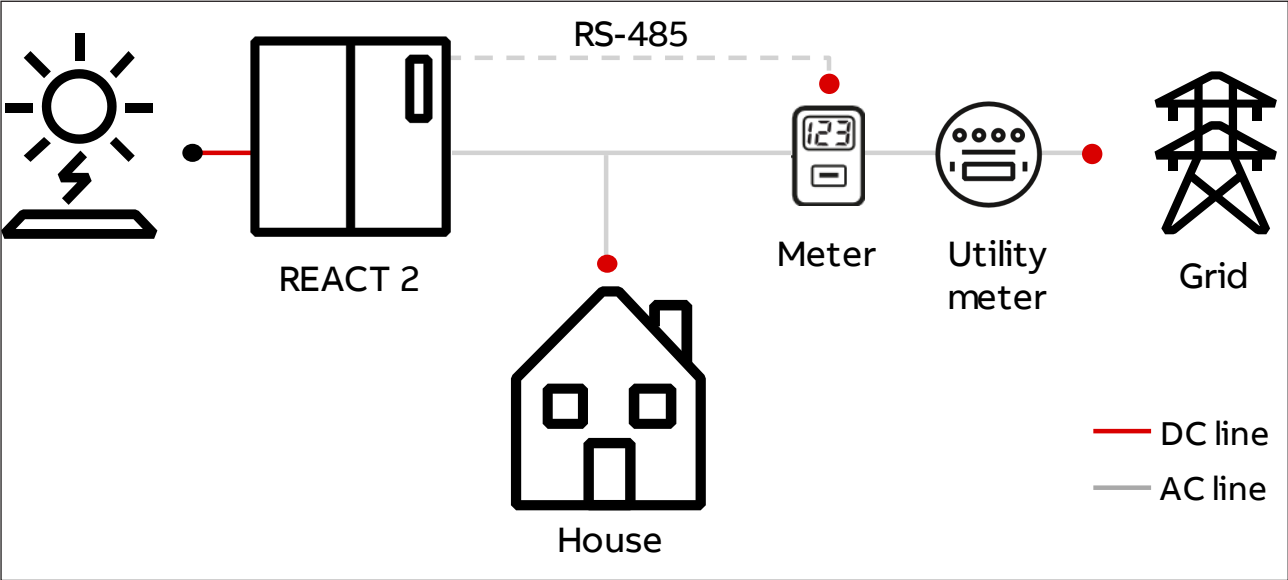

#### Retrofit (existing PV system)

REACT 2 can be installed together with an existing PV inverter on AC side of the home grid, functioning as battery manager only

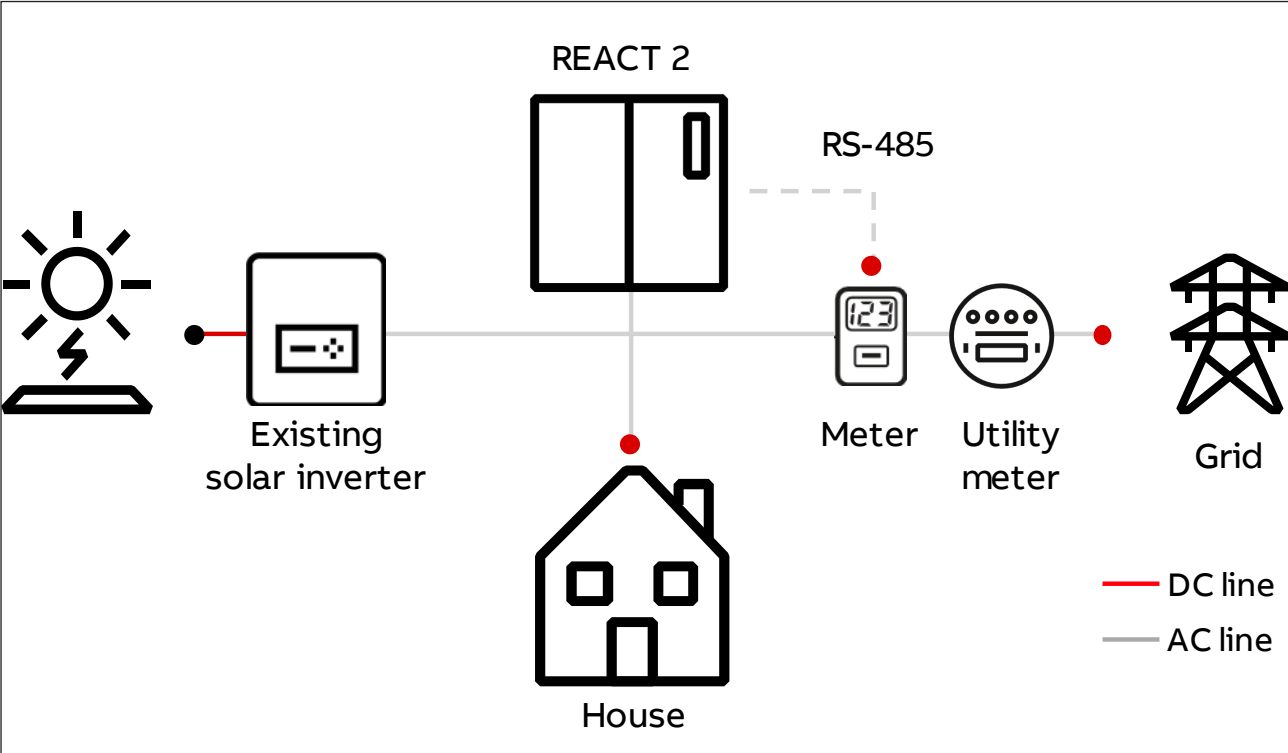

## Connectivity diagram

REACT 2 is equipped with:

- 2 WIFI connections
- 2 Ethernet connections
- Free connection to Aurora Vision cloud
- Dedicated mobile app for home owner

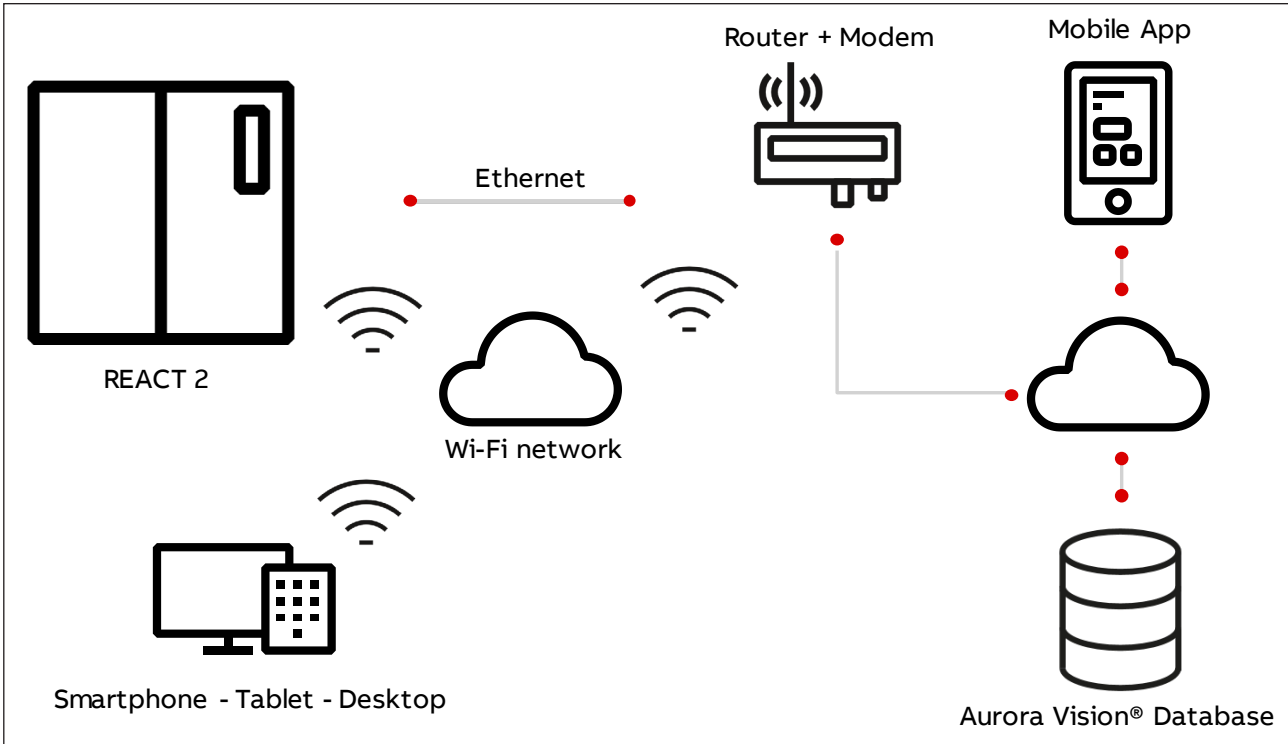

## Operating stages of the system

The REACT2 system enables the storage of unused energy and makes it available during evening hours or times of maximum absorption, enabling self-consumption to be maximised. The main operating stages of the system are:

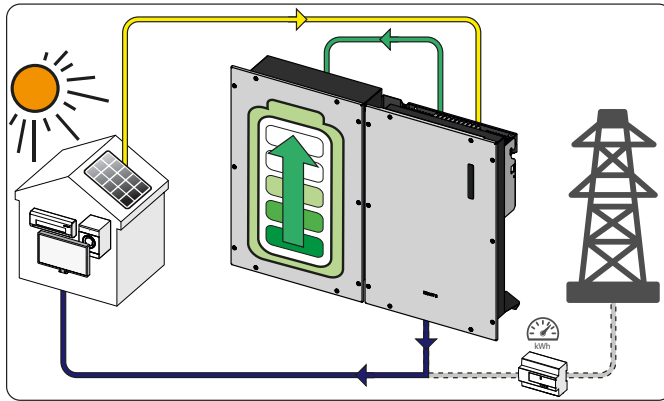

1. The energy from the PV generator is converted by the inverter (REACT2-UNO) and powers the utilities in order to maximise self-consumption. The unused energy produced is stored in the batteries (REACT2-BATT).

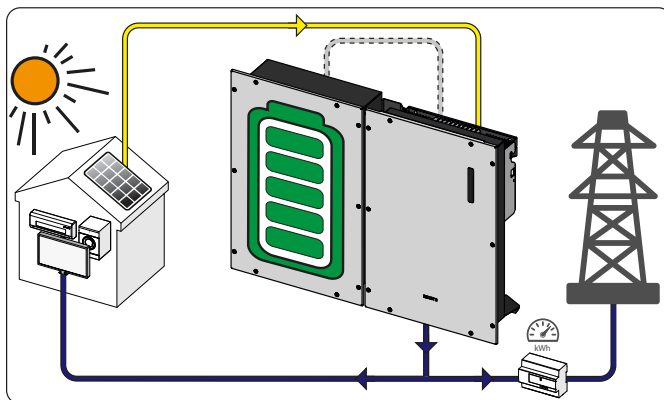

2. Once the batteries are fully charged the system powers the utilities and unused energy is fed into the grid. During this stage it is possible that the maximum limit on active power fed into the grid that was set by the operator may be exceeded; in this case the REACT2 system can automatically limit the feeding of active power to the grid.

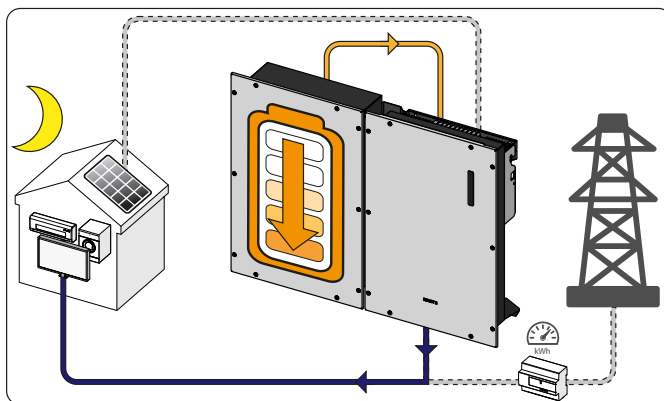

3. When the energy supplied by the PV generator is insufficient to power the utilities, the system supplies the energy stored in the batteries thus enabling greater energy self-sufficiency

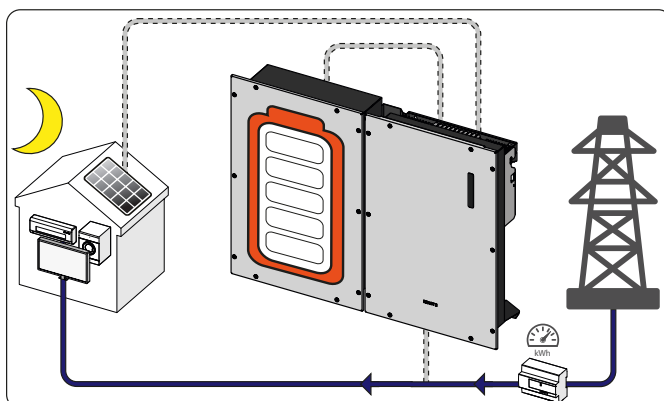

4. When the battery is completely discharged, or if the power supplied by the battery is insufficient, the system will draw energy from the grid



# Functionality and components of the equipment

### Optimisation of self-consumption

REACT2 is equipped with an storage system (4kWh base system, expandable up to 12kWh), which enables use of the photovoltaic energy at different times.

The energy stored in the battery during the day can be used in evening hours or whenever photovoltaic production is not sufficient to meet consumption by domestic utilities.

Compared to a photovoltaic system without storage, self-consumption of photovoltaic energy increases considerably.

### Multi-battery system

Providing a totally flexible solution, REACT2 offers a wide storage capacity, which can be expanded from 4 kWh to 12 kWh, depending on the number of batteries used, and can achieve up to 90 percent energy self-reliance.

The addition of further battery units can take place anytime during the lifetime of the system.

The choice of the storage capacity should be evaluated according to the installation position (irradiation) and according to the domestic consumption.

### Communication and monitoring

REACT2 is equipped with a built-in Wi-Fi/Ethernet logger which enables the configuration and monitoring of the system. The embedded data logger and direct transferring of data to a secure cloud platform allows customers to monitor and keep their system under control through the dedicated mobile app.

The advanced communication interfaces combined with a standard Modbus communication protocol, Sunspec compliant, allow the inverter to be easily integrated within any smart environment and with third party monitoring and control systems.

The system also has an RS-485 serial interface (public communication protocol "Modbus RTU").

### AC BACKUP output - Means of operation

The REACT2 system is equipped with an AC BACKUP output that can be activated in different 2 operating modes:

- Backup Mode: **AUTO**

A necessary condition for activating the backup function is:

- Lack of grid.

- Backup Mode: **External Control**

A necessary condition for activating the backup function is:

- External control (Communication and control signal terminal block , terminal 1-3).

### **Configurable relay (ALARM relay)**

The inverter is equipped with a configurable switching relay, which can be used in different operating configurations. A typical example of its application is closing the contact when an alarm is triggered.



*The relays are not power components (230Vac, 1A Max) and must be used, for example, to control a power relay installed outside the REACT2 system.*

### **Remote switching on and off (Remote ON-OFF)**

This command can be used to switch off/switch on the inverter via an external (remote) command.

This function must be software enabled and, when it is active, switching on the inverter will not only be dictated by the presence of the normal parameters that allow the inverter to connect to the grid, but will also depend on the external on-off command.

### **Reactive power feed into the grid**

The inverter is able to produce reactive power and can feed this power into the grid when the phase factor is set. Managing the feed can be controlled directly by the grid company via a dedicated RS485 serial interface or set by the installer through web server UI.

Power feeding management modes vary according to the country of installation and the grid companies. For detailed information on the parameters and characteristics of this function, please contact FIMER directly.

### **Limiting the active power fed into the grid**

The inverter, if enabled and set using the web server UI, can limit the amount of active power fed into the grid by the inverter to the desired value (expressed as a percentage).

# Topographic diagram of the equipment

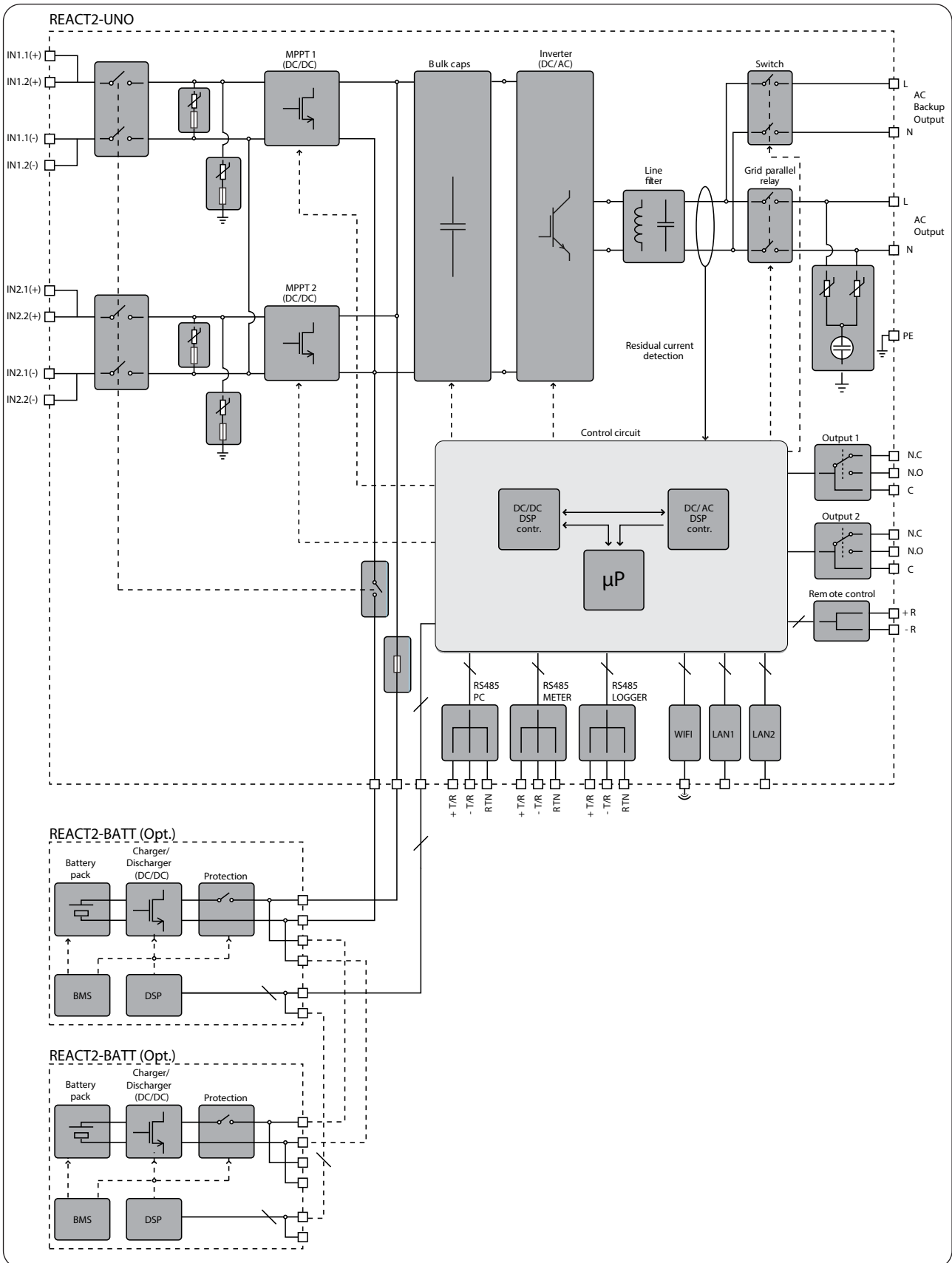

## Safety devices

### Anti-Islanding

In the event of a local grid outage by the electricity company, or when the equipment is switched off for maintenance operations, the inverter must be physically disconnected to ensure the protection of the people working on the grid, in accordance with the relevant national laws and regulations. To prevent possible islanding, the inverter is equipped with an automatic safety disconnection system called "Anti-Islanding".

*Anti-islanding protection mechanisms are different depending on the grid standards, even if they all have the same purpose.*

### Ground fault of the photovoltaic panels

This inverter is to be used with panels connected in "floating" mode, i.e. with no ground connections on the positive and negative terminals. An advanced ground fault protection circuit continuously monitors the ground connection and disconnects the inverter when a ground fault is detected, indicating the fault condition by means of the red "GFI" LED on the front panel.

### REACT2-BATT state of health (SOH)

The state of health (SOH) is defined as the relation between the current capacity and the nominal capacity of the battery (4kWh).

The SOH trend is constantly decreasing for natural aging linked to the use of the battery and is not an indication of its malfunction. The downward inclination of the degradation capacity depends on the actual use and in particular on the number of average daily cycles, and on the environmental working conditions such as temperature and humidity.

The SOH value is automatically measured periodically by the REACT2 system and its value is detectable by the user interfaces. Battery usage will be automatically interrupted when the SOH reaches 60% and displaying Warning (W054).

In case the W054 warning is present, the REACT2 inverter will continue to function as a standard photovoltaic inverter.

### Other safeguards

- Constant monitoring of the grid voltage to ensure that voltage and frequency values remain within operating limits;
- Internal temperature control to automatically limit the power if necessary to prevent overheating of the unit (derating).

*The numerous control systems determine a redundant structure to ensure absolutely safe operations.*

## Safety and accident prevention

# 3

### Safety information and instructions

The equipment has been manufactured in accordance with the strictest accident-prevention regulations and supplied with safety devices suitable for the protection of components and operators.



*For obvious reasons, it is not possible to anticipate the great number of installations and environments in which the equipment will be installed. It is therefore necessary for the customer to appropriately inform the manufacturer about particular installation conditions.*

**FIMER** accepts no liability for failure to comply with the instructions for correct installation and cannot be held responsible for the upstream or downstream equipment.



*It is essential to provide operators with correct information. They must therefore read and comply with the technical information provided in the manual and in the attached documentation.*



The instructions provided in the manual do not replace the safety devices and technical data for installation and operation labels on the product, and they do not replace the safety regulations in force in the country of installation.

The manufacturer is willing to train staff, at its premises or on site, in accordance with conditions agreed to in the contract.



*Do not use the equipment if you find any operating anomalies.*

Avoid temporary repairs. All repairs should be carried out using only genuine spare parts, which must be installed in accordance with their intended use.

Liabilities arising from commercial components are delegated to the respective manufacturers.

## Hazardous areas and operations

### Environmental conditions and risks

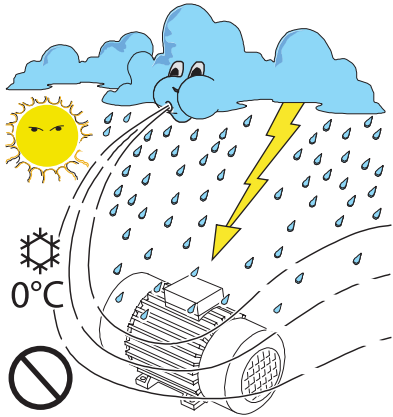

The equipment is to be installed in locations with suitable environmental conditions which observe the safety conditions and do not prevent its regular operation. These conditions are listed in the technical data and in the installation chapter.

FIMER is not responsible for any loss of the equipment, or part of it, which does not take place on the basis of the regulations and laws in force in the country of installation.

The same precautions should be adopted for dismantling the equipment.

The equipment is not designed to operate in environments that are particularly inflammable or explosive.

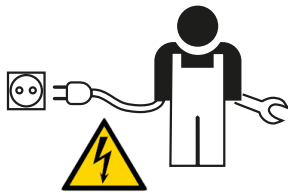

The customer and/or installer must appropriately train operators or anyone who may come into close proximity of the equipment, and highlight, with notices or other means where necessary, the hazardous areas or operations at risk : **magnetic fields, hazardous voltages, high temperatures, possible discharges, generic hazard, etc.**

Keep out of the reach of children



### Signs and labels

The labels affixed on the equipment must strictly NOT be removed, damaged, defaced, hidden, etc.



The labels must be regularly cleaned and kept in sight, i.e. NOT hidden by foreign objects and parts (rags, boxes, equipment, etc.)

The technical data provided in this manual does not in any case replace that shown on the labels affixed on the equipment.

## Thermal and electrical hazard

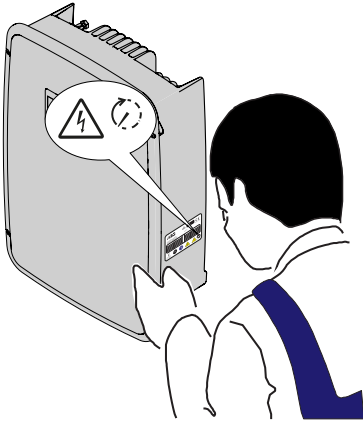

*CAUTION: the removal of guards or covers is permitted by qualified personnel only after the equipment has been put out of service and after the period of time indicated on the label has passed. This is to let the components cool down and allow the internal capacitors to discharge.*

When the equipment has just been switched off, it may have hot parts as a result of overheating of the heated surfaces (e.g.: transformers, accumulators, coils, etc.) so be careful where you touch.

## Clothing and protection of personnel

FIMER has done its best to eliminate sharp edges and corners, but as this is not always possible you are advised always to wear the clothing and personal protection equipment provided by the employer.

*Personnel must not wear clothes or accessories that could start fires or generate electrostatic charges or, in general, clothing that can compromise personal safety.*



All operations on the equipment should be performed with suitably insulated clothing and tools.

E.g.: insulating gloves, class 0, RC category

Maintenance operations may only be performed after the correct procedure for taking the equipment out of service has been carried out.

*Personnel must NOT go near the equipment with bare feet or wet hands.*

The maintenance technician must in any case ensure that no one else can switch on or operate the equipment during the maintenance operations, and should report any anomaly or damage due to wear or ageing so that the correct safety conditions can be restored.

The installer or maintenance technician must always pay attention to the work environment, ensuring that it is well-lit and there is enough room to ensure an escape route.

During installation, consider whether the **noise emitted in that particular environment** might exceed the legal thresholds (less than 80 dBA); if so, suitable ear protection must be worn.



## Safety precautions relating to REACT2-BATT

Battery System provides a safe source of electrical energy when operated as intended and as designed.

Potentially hazardous circumstances such as excessive heat or electrolyte mist may occur under improper operating conditions, damage, misuse and/or abuse. The following safety precautions and the warning messages described in this Part must be observed.



**HIGH VOLTAGE – ELECTRIC SHOCK HAZARD.** Do NOT open any cover of REACT2-BATT

### **Organic Solvent Electrolyte**

Cell components of Battery System contain organic solvent-based electrolyte. Breach of individual cells may allow some electrolyte to be released from the cell. Direct contact with the liquid electrolyte can cause skin irritation.

If contact with the liquid electrolyte occurs, follow the suggestions below to minimize the chance of injury:

- Flush eyes immediately with cold running water for at least 15 minutes.
- Rinse skin immediately with water for at least 15 minutes.
- Remove clothing if soiled.
- Seek immediate medical attention.

### **Electrolyte Vent Product**

Organic solvent electrolyte vent products are flammable. To avoid of flammable products, the following guidelines must be observed:

- Operate the Battery System under conditions only as specified
- Keep sparks, flames and smoking materials away from the Battery
- Do not incinerate, puncture or impact the Battery System.
- Do not solder or weld to the Battery System.



**HAZARD.** The hazard warnings (set out below) are used to indicate risks or unsafe practices that CAN cause serious injury or death.

- DO NOT dismantle or disassemble any parts.
- DO NOT set light to or heat.
- DO NOT use or leave near a naked flame, boiler or heated places (beyond the temperature range indicated in the technical data).
- DO NOT wet with fresh or salt water.
- DO NOT create damaging impacts or drop.
- DO NOT use for other equipment.
- DO NOT touch directly if there is a leak of electrolyte material.
- DO NOT touch if it shows any breaks in the cover where any parts under voltage are visible.
- DO NOT use should a fault or any anomaly (such as in smell, heat, colour, smoke, shape or noise) be found.





*WARNING. The warnings (set out below) are used to indicate risks or dangerous actions which COULD cause serious personal harm or damage to the product or property.*

- *Do not use with other inverter models if not expressly indicated by FIMER.*
- *Do not use if is leaking of electrolyte material.*
- *Do not use if anomalies are present. Should the battery unit have a bad smell, changes in colouring, deformation or other anomalous conditions during use (including charging and storage), do not use it.*



*CAUTION. The caution messages (set out below) are used to indicate risks or dangerous actions which could cause serious harm to people or damage to property.*

- *Do not use or leave exposed to direct sunlight (or in a vehicle which is exposed to the sun). The REACT2-BATT could produce heat, smoke, breakages or flames. In addition, its performance might deteriorate and/or it might have a shorter lifespan.*



*Final installation of the equipment must not hinder access to any externally located disconnection devices.*

## Residual risks



Despite the warnings and safety systems, there are still some residual risks that cannot be eliminated.

These risks are listed in the following table with some suggestions to prevent them.

**Table of residual risks**

RISK ANALYSIS AND DESCRIPTION	SUGGESTED REMEDY
Noise pollution due to installation in unsuitable environments or where staff work permanently.	Reassess the environment or the place of installation.
Suitable local ventilation that does not cause overheating of the equipment and is sufficient not to create discomfort to people in the room.	Restore suitable ambient conditions and air the room.
External weather conditions, such as water seepage, low temperatures, high humidity, etc.	Maintain ambient conditions suitable for the system.
Overheating of surfaces at temperature (transformers, accumulators, coils, etc. ) can cause burns. Also be careful not to block the cooling slits or systems of the equipment.	Use suitable protective equipment or wait for the parts to cool down before switching on the equipment.
Inadequate cleaning: compromises cooling and does not allow the safety labels to be read.	Clean the equipment, labels and work environment adequately.
Accumulation of electrostatic energy can generate hazardous discharges.	Ensure the devices have discharged their energy before working on them.
Inadequate training of staff.	Ask for a supplementary course.
During installation, temporarily mounting the equipment or its components may be risky.	Be careful about and disallow access to the installation area.
Accidental disconnections of the quick-fit connectors with the equipment in operation, or wrong connections, may generate electric arcs	Be careful about and disallow access to the installation area.

## ***Lifting and transport***

# 4

### **General conditions**

Storage, handling and transport must comply with particular rules and regulations indicated in the subsequent paragraphs.

The lifting and transporting of pallets containing the equipment can be done using pallet trucks or forklifts, by picking up the pallet in the area intended for lifting.

The transport of individual boxes containing the equipment must be done using suitable means and with careful supervision by authorised staff.

The accident and safety prescriptions for handling and lifting operations must be complied with.

## Storage of equipment

### Special rules for storage of REACT2-BATT

The storage period of the REACT2-BATT begins from the date, on which the product is produced by FIMER (the production date is indicated on the product label placed on the lateral surface of the chassis and expressed as week of production - Year of production). In order to guarantee the full operation of the system, REACT2-BATT shall be put into service within 6 months at most of the date of delivery by FIMER to the recipient of the goods.

In order to reduce risks during storage of the REACT2-BATT it must be considered that:

- Do not stack more than 4 REACT2-BATT boxes.
- Keep the boxes upright. Do not store upside down or on the sides.
- Storage temperature shall be in the range of -20 to +25°C (6 month storage time) or -20 to +45°C (3 month storage time).
- Storage humidity shall be less than 80% RH non-condensing.
- Capacity degradation will occur depending on storage time, temperature, and humidity.
- To minimize capacity degradation, storing in a dry place with temperature less than 25°C.

For the rules on storing the battery, refer to the regulations in force in the country concerned. In addition to the regulations in force in the Country of interest, the following recommendations should be followed:

- Store the Battery Unit in its original packing (including the pallet), in a dry, cool, well-ventilated environment and away from water.
- Do not open/tamper with the original packing.
- Do not crush/deform the packing.
- Equip the storage environment with appropriate PPE.
- Never leave the REACT2-BATT in places where these may be accidentally hit and damaged.
- Never leave the REACT2-BATT in areas with high fire risk or in high-temperature areas.
- In the static position, the strapped batteries can be stacked up to a maximum of 4 units.
- Handling and loading onto means of transport is only allowed with a stack of maximum 2 units.

## Lifting

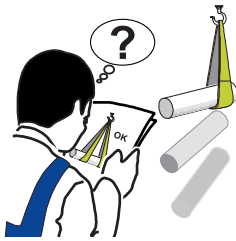

FIMER usually stores and protects individual components by suitable means to make their transport and subsequent handling easier. Nonetheless, as a rule, it is necessary to turn to the experience of specialised staff to take charge of loading and unloading components. Where indicated and/or available, eyebolts or handles, which can be used as anchorage points, are inserted and/or can be inserted.



*The number of required operators necessary to lift the equipment must be in accordance to local regulations relating lifting limits per operator.*



*The ropes and means used for lifting must be suitable for bearing the weight of the equipment.*

Do not lift several units or parts of the equipment at the same time, unless otherwise indicated.

## Equipment weight

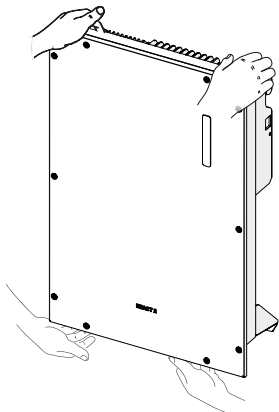
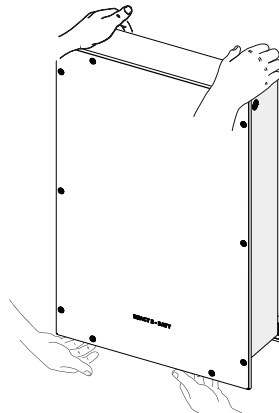

*Risk of injury due to the weight of the equipment. Take care during lifting and transport*

Device	Weight (kg/lb)	Lifting points
REACT2-UNO-3.6/5.0-TL	< 22 kg	4 (suggested in case of 2 operators) 
REACT2-BATT	50 kg	4 (suggested in case of 2 operators) 

## Transport of the equipment

Transportation of the equipment, especially by road, must be carried out using appropriate vehicles and methods to protect the components (particularly electronic components) from violent shocks, humidity, vibration, etc.



*Note for REACT2-BATT: the road transport is regulated by the ADR international agreement.*



*During handling, do not make any sudden or fast movements that can create dangerous swinging.*

## Road transport of Battery Unit

The road transport of dangerous goods is regulated by the ADR international agreement.

The Battery Unit is identified in the ADR document by the number UN 3480 (LITHIUM-ION BATTERIES) in hazard CLASS 9. The battery unit, in its original packing, is compliant for road transport.

The ambient temperature allowed for transport is from -5°C to +40°C. The manufacturer guarantees the characteristics of the REACT2-BATT only if the aforementioned condition is respected.

### Transport of new batteries

The transport of Battery Units must comply with the general application of the ADR. For any exemptions, please refer to paragraphs 1.1.3.1 and 1.1.3.6 of the ADR document.

### Transport of end-of-life batteries

Besides complying with the general application of the ADR, Battery Units which are transported for disposal must comply with the following guidelines:

- Be packed in accordance with packing instruction P909 of 4.1.4.1 (original package of REACT2-BATT)
- The packages shall bear the following indication: "LITHIUM BATTERIES FOR DISPOSAL", in addition to other labels and indications provided for in the ADR.



*For further details, please refer to the ADR document: "European Agreement concerning the International Carriage of Dangerous Goods by Road", special regulation 377.*



*Contact FIMER for further details regarding the correct battery unit disposal procedures.*

## Unpacking and checking

Bear in mind that the packaging elements (cardboard, cellophane, staples, adhesive tape, straps, etc.) may cause cuts and/or injuries if not handled with care. They should be removed by suitable means and not left in the hands of individuals who are not responsible (e.g. children).



*The packaging components must be disposed of in accordance with the regulations in force in the country of installation.*

When you open the package, check that the equipment is undamaged and make sure all the components are present.

If any defect or damage is detected, please stop, contact the carrier and also promptly inform the FIMER Service .

## General Handling Information

*When the REACT2-BATT is out of the package, pay attention to:*



- Do not short circuit the positive (+) and negative (-).
- Avoid contacting between the metals and the battery unit.
- Do not use seriously scarred or deformed battery unit.
- Do not damage sheath of connectors.

## List of components supplied



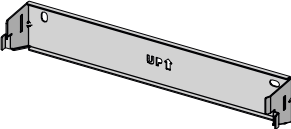
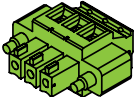
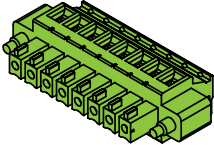
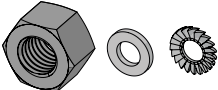
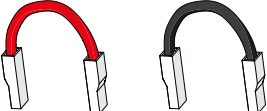

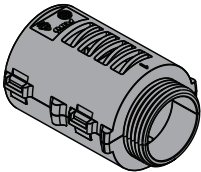
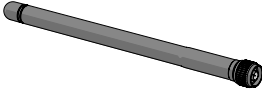
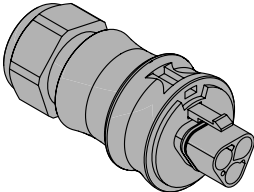
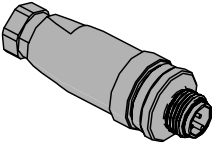

Inside the package the following components required to correctly install the inverter are supplied

Components supplied together with the inverter **REACT2-UNO**:

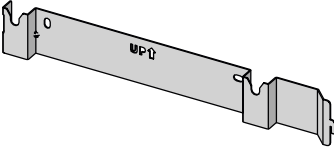
Components available for REACT2-UNO	Quantity	
	Bracket for REACT2-UNO wall mounting	1
	Connector for connection of the multifunctional relay	2
	Connector for connecting the communication and control signals	1
	M5 hex nuts , M5 flat washer and M5 serrated lock washers for protective earth cable installation	1 + 1 + 1
	Jumpers for configuration of the parallel input channels	1 (red) + 1 (black)

Components available for REACT2-UNO		Quantity
	EMI filter for AC output (BACKUP) cable gland 16	1
	Wi-Fi antenna	1
	AC output (GRID) connector 17 counterpart	1
	METER connector 14 counterpart	1
	Technical documentation	1

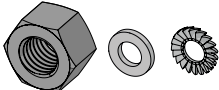
Components supplied together with the inverter **REACT2-BATT**:

Components available for REACT2-BATT		Quantity
	Bracket for REACT2-BATT wall mounting	1
	REACT2-BATT power connection cable	1
	REACT2-BATT signal connection cable	1
	Cable lug for earth cable	2
	M5 hex nuts , M5 flat washer and M5 serrated lock washers for protective earth cable installation	1 + 1 + 1
	Technical documentation	1



## General conditions

*The device is installed depending on the system and the place where the device is installed. Its performance therefore depends on the correctness of the connections.*

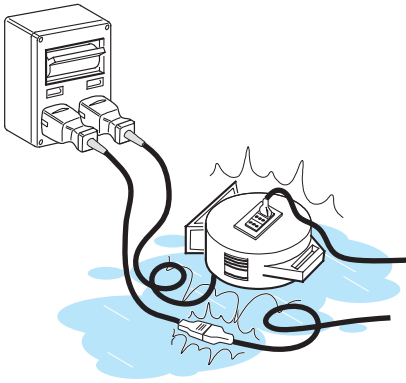

Staff authorised to carry out the installation must be specialised and experienced in this job. They must also have received suitable training on equipment of this type.

The operation must be carried out by qualified personnel and it is advisable to adhere to the indications provided in this manual, the diagrams and the enclosed documentation.



*For safety reasons, only a qualified electrician who has received training and/or demonstrated skills and knowledge on the structure and operation of the unit may install the inverter.*



*The installation must be performed by qualified installers and/or licensed electricians in accordance with the existing regulations in the country of installation.*



*The removal of the inverter panels/covers allows access to the area dedicated to service personnel (the operator is not authorized to access this area)*



*Connection of the photovoltaic system to an electric installation connected to the distribution grid must be approved by the electricity provider.*



*The installation must be carried out with the equipment disconnected from the grid (power disconnect switch open) and with the photovoltaic panels shaded or isolated.*



*When the photovoltaic panels are exposed to sunlight they provide continuous DC voltage to the inverter.*

## Environmental checks

- See characteristics and technical data paragraph to check the required environmental conditions (protection rating, temperature, humidity, altitude, etc.).
- The installation location shall be easily accessible.
- Prevent access to the installation location by children.
- Installation of the unit in a location exposed to solar rays makes the warranty void as it may cause:
  - power limitation phenomena in the inverter and in the battery unit.
  - premature wear of the electrical/electromechanical components.
  - premature wear of the mechanical components (gaskets) and of the user interface (synoptic).
  - reduction in performance, lifetime and possible damage of the battery unit.

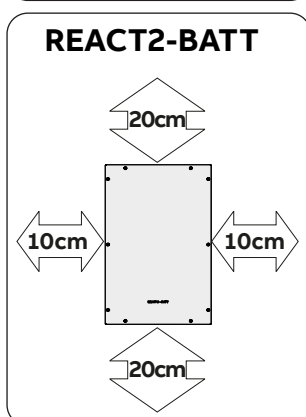
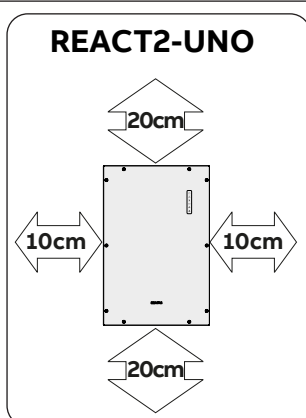
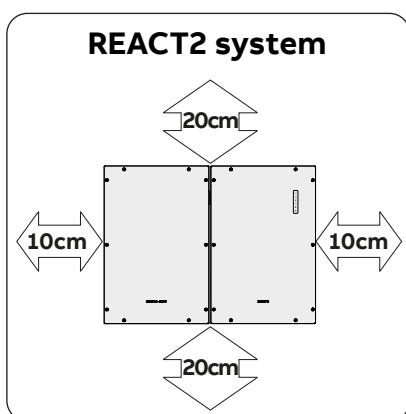

- Do not install in small closed rooms where air cannot circulate freely.
- Always ensure that the flow of air around the inverter is not blocked so as to prevent overheating.
- Do not install in locations where flammable substances or gases may be present.
- Do not install on wooden walls or near flammable substances.
- Do not install in locations with a constant presence of water and/or high humidity level.
- Respect the minimum distances from objects around the REACT2-UNO and REACT2-BATT that could prevent the inverter installation and restrict or block the air flow.
- The installation must take account of any electrical devices (e.g. lamps, switches, etc.) which must be at least 20cm from the equipment. These distances must be maintained also to facilitate the circulation of the air needed to cool the unit and to facilitate the operations to install/maintain hardware and software which is done by dismantling the covers placed on the front.
- Install vertically with a maximum inclination of 5° (forward or backward).
- Do not install in rooms where people live or where the prolonged presence of people or animals is expected, because of the noise that the system produces during operation. The level of the sound emission is heavily influenced by where the appliance is installed (for example: the type of surface around the inverter, the general properties of the room, etc.) and the quality of the electricity supply.

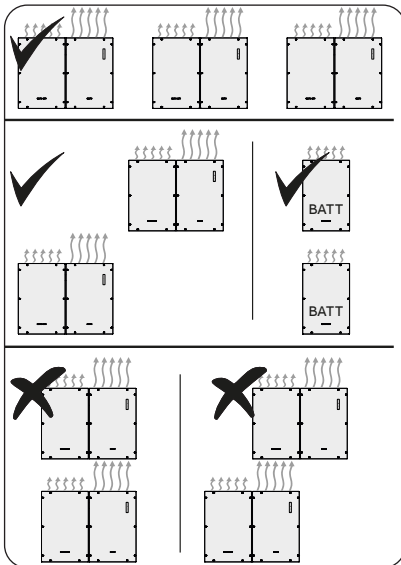

- Avoid electromagnetic interference that can compromise the correct operation of electronic equipment, with the consequent hazards.

- For a multiple installation, position the inverters side by side. If the space available does not allow this arrangement, position the inverters in a staggered arrangement (as shown in the figure) so that heat dissipation is not affected by other inverters.
  - Two or more REACT2-BATT can be installed one above the other.
  - Do not install the REACT2-BATT above the REACT2-UNO.

- The ambient temperature of the installation location should be between 5°C and 30°C to guarantee the optimal operation of the battery unit (REACT2-BATT). Here below are the functions available from the system on the basis of the ambient temperature:
  - T1 - Optimal operation of the REACT2 system
  - T2 - Correct operation of the REACT2 system with possible reduction of power
  - T3 - Operation limited to the inverter part only. Management of the battery is disabled.

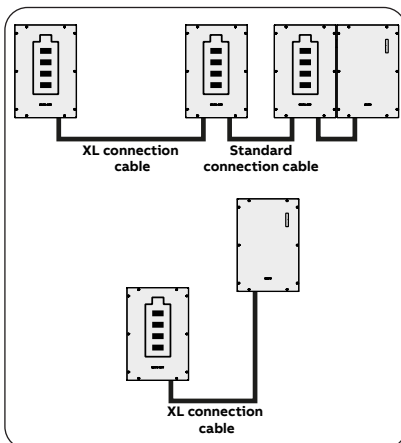
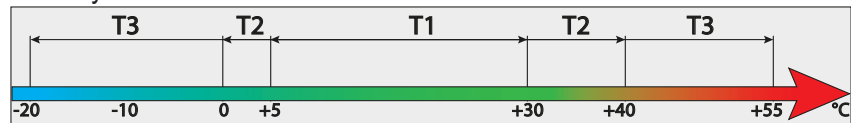

- The REACT2-UNO and REACT2-BATT can be installed separately using the standard cable. Moreover in case of greater distances, the installation is possible using the “REACT2-XL-CABLE-KIT” cable kit (2 meter cables length).

- Hardware and software maintenance on REACT2-UNO entails opening the front cover. Check that the correct installation safety distances are observed in order to allow routine check and maintenance operations.
- Install on a wall or strong structure suitable to bear the weight.
- Install at a height which takes into consideration the weight of the appliance and in a position which is suitable for servicing, unless suitable means are provided to carry out the operation.
- If possible, install at eye-level so that the synoptic can be seen easily.

## Wireless signal environmental checks

The wireless communication is used to perform commissioning and monitoring on the inverter. The WLAN board of the inverter uses radio waves to transmit and receive data, it is therefore important to assess this factor in order to have optimal installation.

- Walls in reinforced cement and surfaces covered in metal (doors, shutters, etc.) can markedly reduce the reach of the device which even in optimal conditions, should be of approximately 50 metres in free space.
- It is therefore recommended that before installing the inverter, the strength of the wireless signal is checked, using a mobile device (smartphone, tablet or notebook) and connecting to the wireless router from a position which is close to the installation site of the inverter.

The radio signal level between the inverter and the wireless router can be improved in a number of ways:

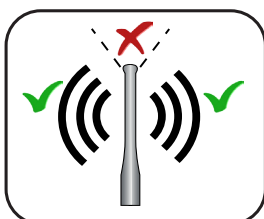

1. Change the direction of the antenna.

The antenna has a dead zone at its tip, which should not be positioned facing the wireless router, as shown in the figure.

2. Find a new position for the router considering the different types of materials which the radio signal will have to pass through:

Material	Relative signal reduction
Open field	0% (strength of approximately 50 metres)
Wood / Glass	From 0 to 10%
Stone / Plywood	From 10 to 40%
Reinforced concrete	From 60 to 90%
Metal	Up to 100 %

The quality of the RF signal can be assessed during the installation stage where the signal is displayed in dBm.

3. Install a wireless signal repeater and place it in an area between the inverter and the router, trying to make sure that the most critical obstacles are avoided.

## Installations above 2000 metres

On account of the rarefaction of the air (at high altitudes), particular conditions may occur that should be considered when choosing the place of installation:

- Less efficient cooling and therefore a greater likelihood of the device going into derating because of high internal temperatures.
- Reduction in the dielectric resistance of the air which, in the presence of high operating voltages (DC input), can create electric arcs (electrical discharges) that may damage the device.

As the altitude increases, the failure rate of some electronic components increases exponentially.



*The inverter operates normally up to 2000 meters.  
Above 2000 meters the inverter works in derating (second curve derating by altitude).*

## Installations with a high level of humidity



*Never open the inverter in the case of rain, snow or a level of humidity >95%.  
Always carefully seal all unused openings.*

Even though the device is equipped with an anti-condensation valve, air with extremely high levels of humidity can lead to the creation of condensation inside the inverter.

As the inverter is almost completely insulated from the outside, condensation can also form after installation in certain weather conditions.

## Mounting instruction - REACT2 system

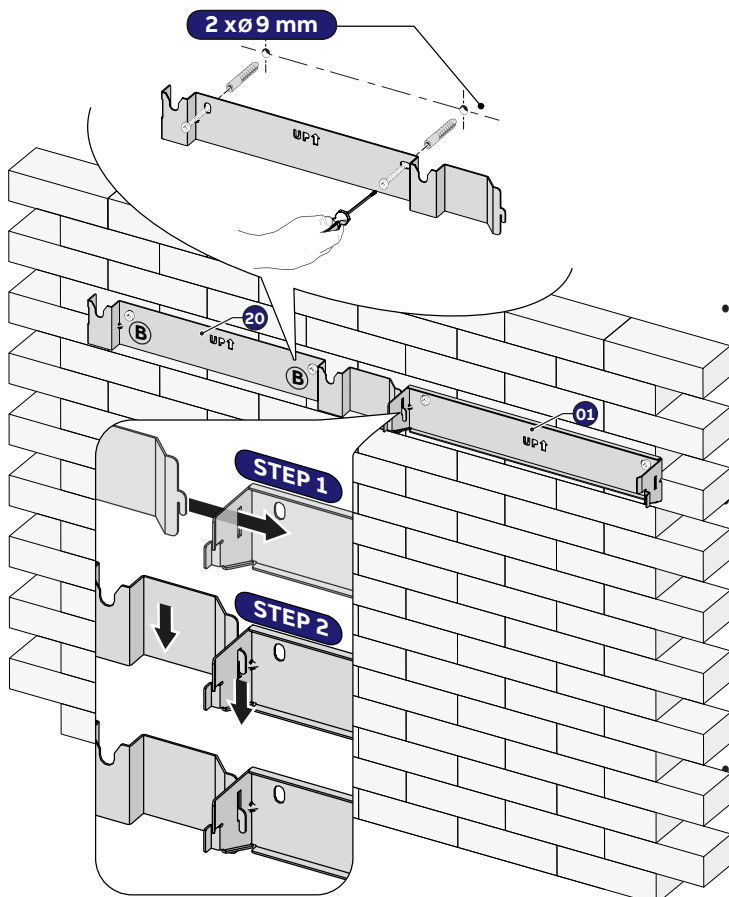
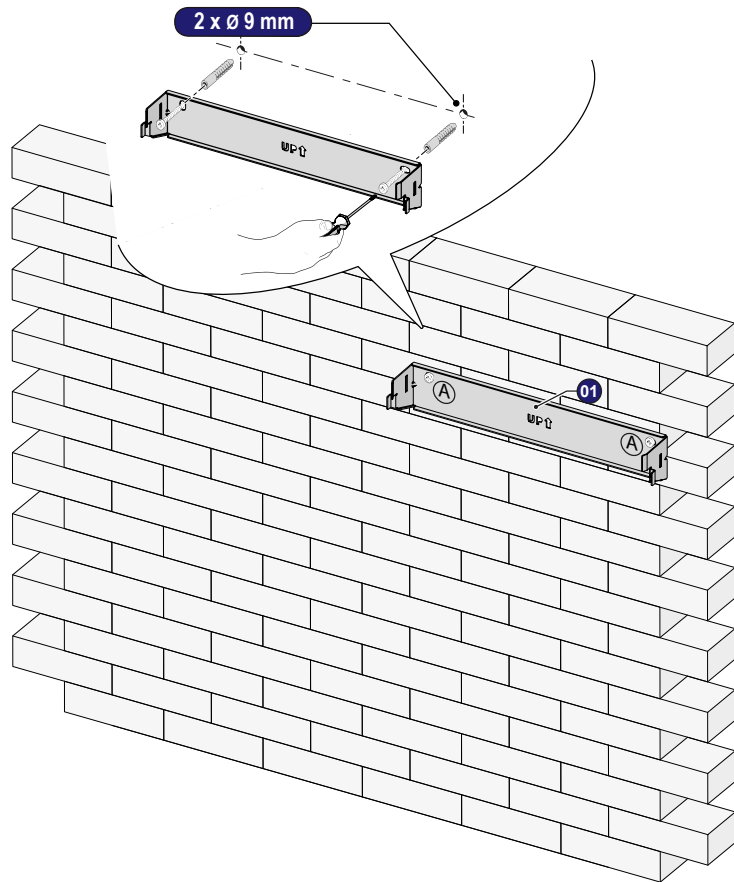

- Position the REACT2-UNO bracket **01** so that it is perfectly level on the wall and use it as a drilling template.
- It is the installer's responsibility to choose an appropriate type of screw anchors for the attachment points. The choice must be based on the type of support (wall, frame or other support), the type of anchors to be used, and their ability to support 4 times the inverter's weight (4x22Kg=88Kg). Depending on the type of anchor chosen, drill the required 2 holes **A** to mount the bracket.
- Fix the REACT2-UNO bracket **01** to the support.



The underlying procedure is related to the side-by-side installation of REACT2-BATT. Alternatively, it is possible to install the REACT2-BATT separately and at greater distances using the "REACT2-XL-CABLE-KIT" cable kit (2 meter cables length).





- Position the REACT2-BATT bracket **20** so that it is perfectly level on the wall and use it as a drilling template. To align the two brackets use the reference point and follow the steps as in the picture.
- It is the installer's responsibility to choose an appropriate type of screw anchors for the attachment points. The choice must be based on the type of support (wall, frame or other support), the type of anchors to be used, and their ability to support 4 times the inverter's weight (4x50Kg=200Kg).
- Depending on the type of anchor chosen, drill the required 2 holes **B** to mount the bracket.
- Fix the REACT2-BATT bracket **20** to the support.

- Lift the REACT2-BATT up to the bracket and insert the heads of two anchor points (present on the back of the battery unit) into the slots  on the bracket .

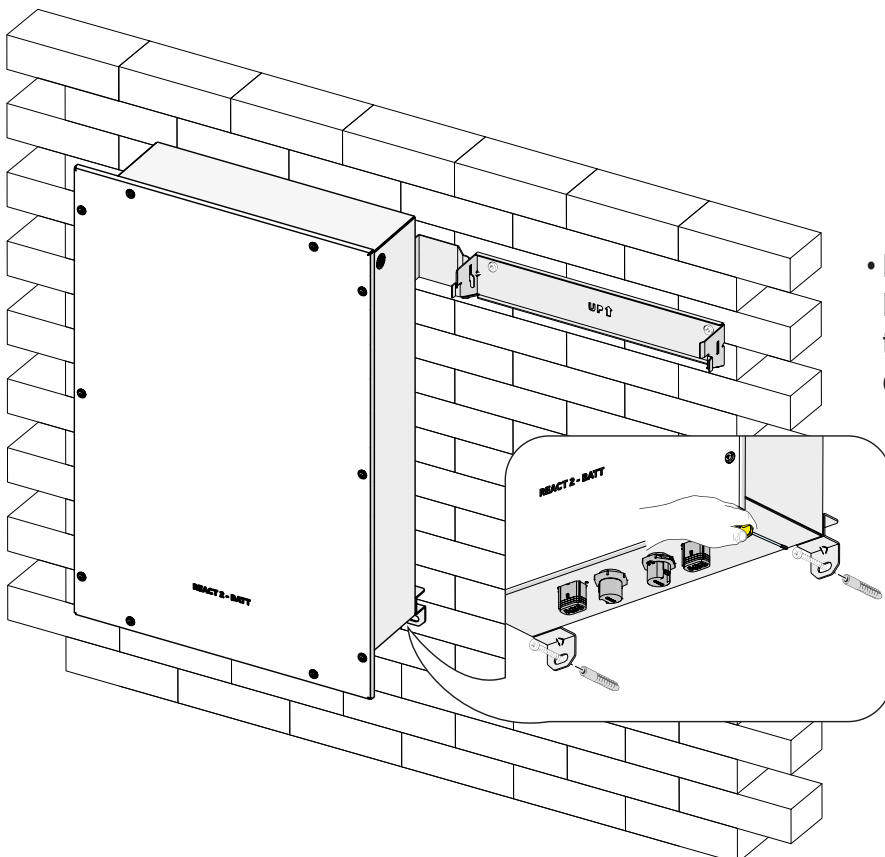
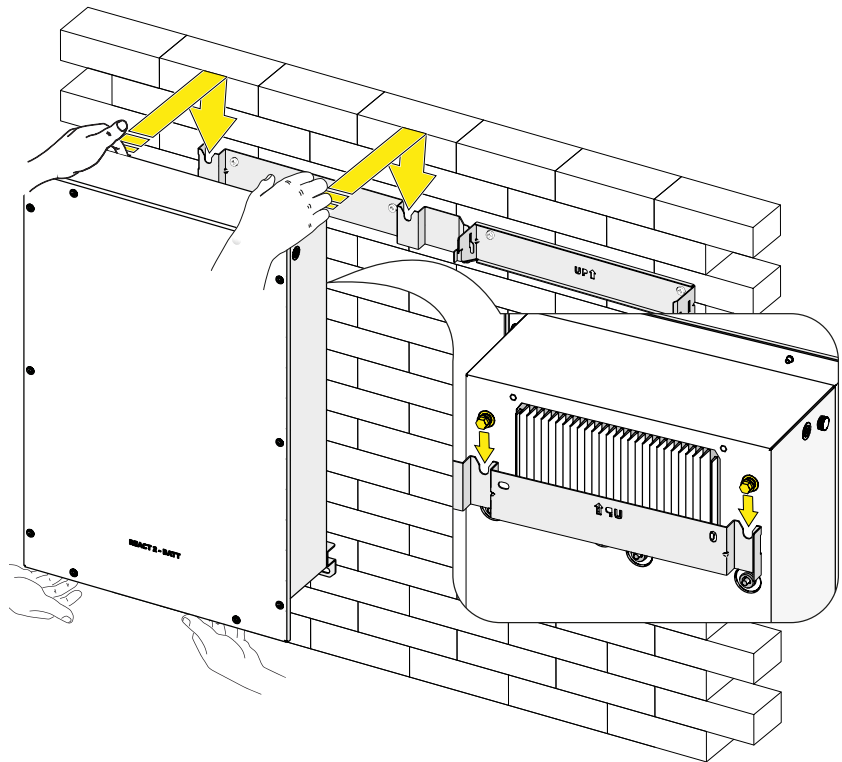

Risk of injury due to the heavy weight of the equipment.



- Hang up the lower part of the REACT2-BATT to the wall using the two anchor points  (holes diameter 11 mm).

- Carefully lift the REACT2-UNO and hook it to the bracket 01 by inserting the two supports in the slots on the inverter.



Risk of injury due to the heavy weight of the equipment.

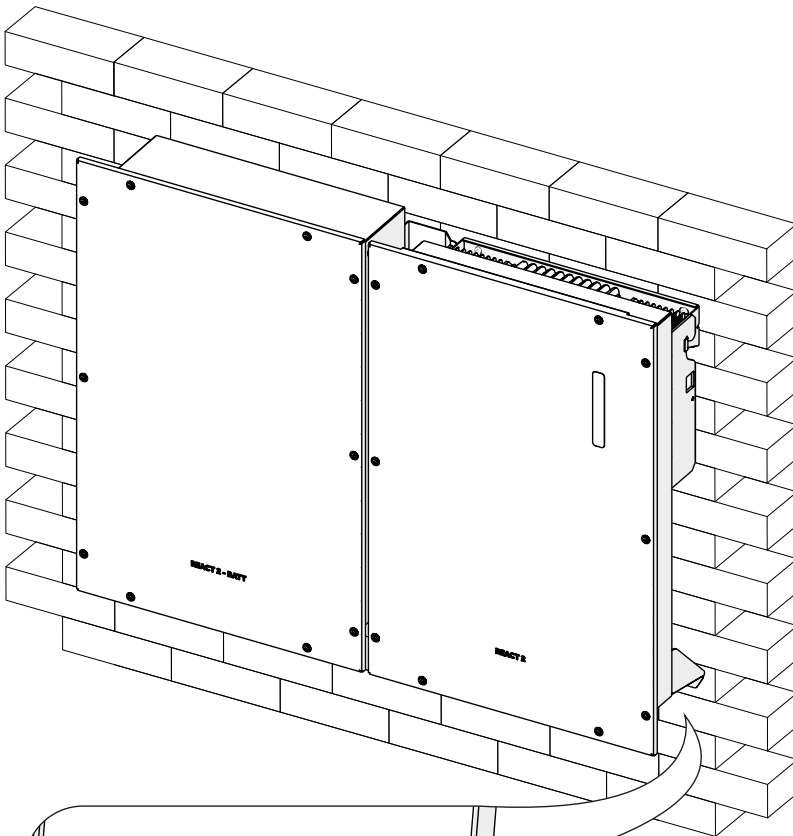
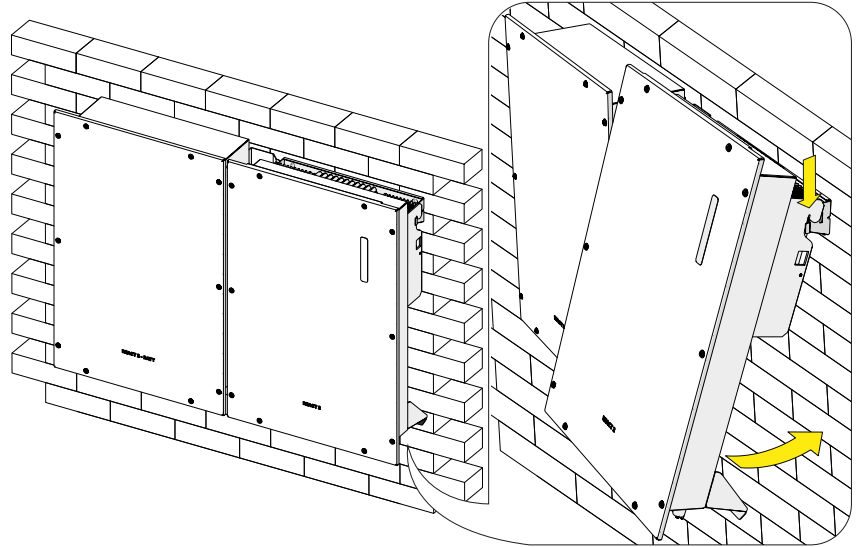

- Hang up the lower part of the REACT2-UNO to the wall using the one anchor point (hole diameter 11mm).

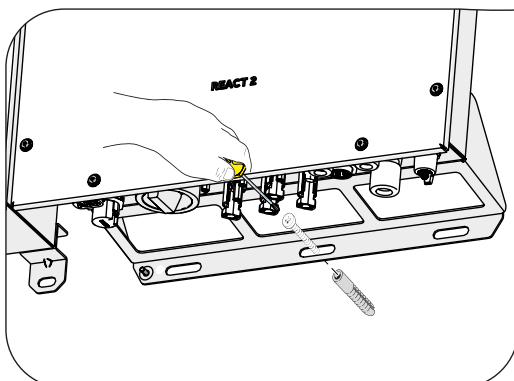



- Remove the caps from the battery connectors:
  - To remove the battery signal connectors 08 simply pull it.
  - To remove the battery power connectors 09 press the latch (highlighted in red) and pull it off.

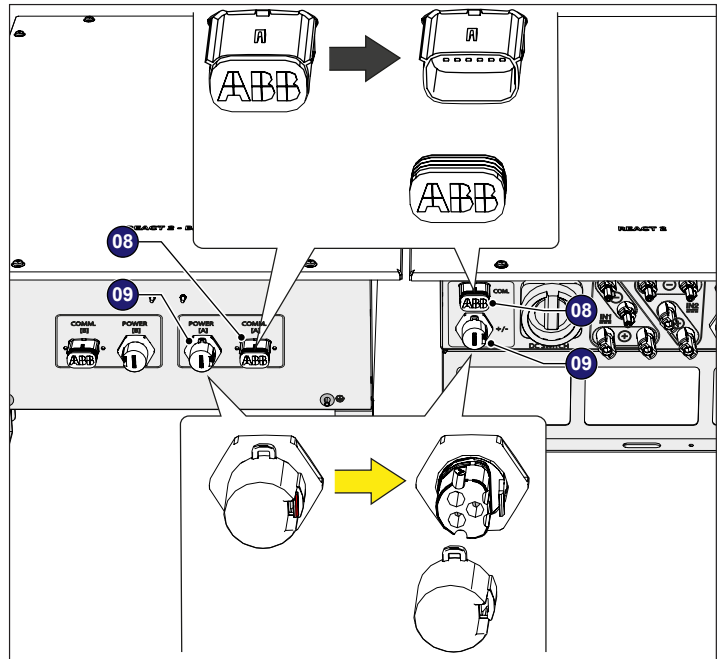

To avoid risks of electrical shock and battery damage (notified by E097 error), all wiring operations must be carried out with AC disconnected and DC switch in OFF position. Faulty units are considered out of warranty.

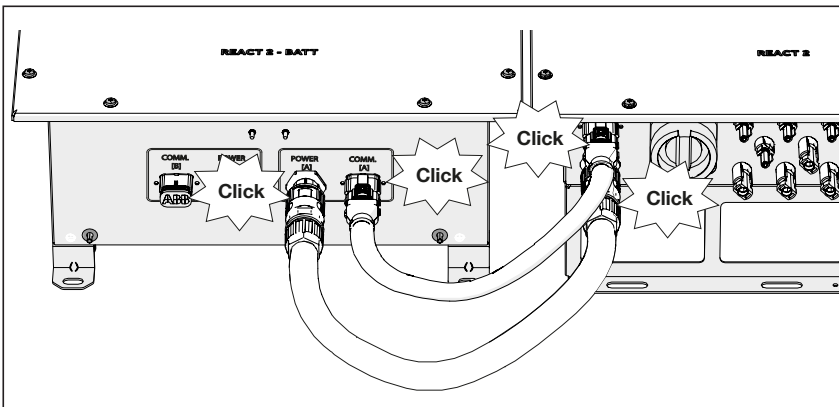

- Connect the two battery cables between inverter and battery unit (supplied inside the REACT2-BATT box).
- Give each cable a pull test to confirm the connection is secure.

- Remove the protective cover from the connector of the Wi-Fi antenna 22 located on the lower part of the REACT2-UNO 02 and install the Wi-Fi antenna (supplied inside the REACT2-UNO box) by screwing it into the specific connector.

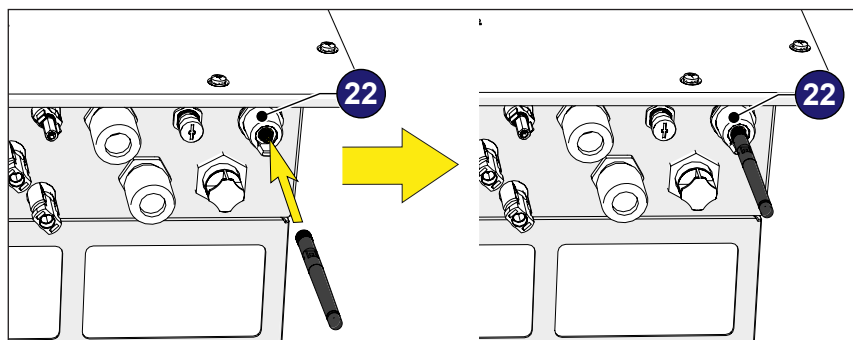

- Make the electric connections using personal protective clothing and/or equipment, such as insulating gloves.
- Proceed with installation of the FIMER energy meter.

## Mounting instruction - REACT2 multi battery system



The underlying procedure is related to the side-by-side installation of REACT2-BATT. Alternatively, it is possible to install the REACT2-BATT separately and at greater distances using the “REACT2-XL-CABLE-KIT” cable kit (2 meter cables length).

- Position the REACT2-BATT bracket 20 of the second REACT2-BATT so that it is perfectly level on the wall and use it as a drilling template. To align the brackets of the two REACT2-BATT (in case of side-by-side installation) use the reference point and follow the steps as in the picture.
- It is the installer’s responsibility to choose an appropriate type of screw anchors for the attachment points. The choice must be based on the type of support (wall, frame or other support), the type of anchors to be used, and their ability to support 4 times the inverter’s weight (4x50Kg=200Kg).
- Fix the REACT2-BATT bracket 20 to the support.
- Lift the REACT2-BATT up to the bracket and insert the heads of two anchor points (present on the back of the battery unit) into the slots T on the bracket 20.

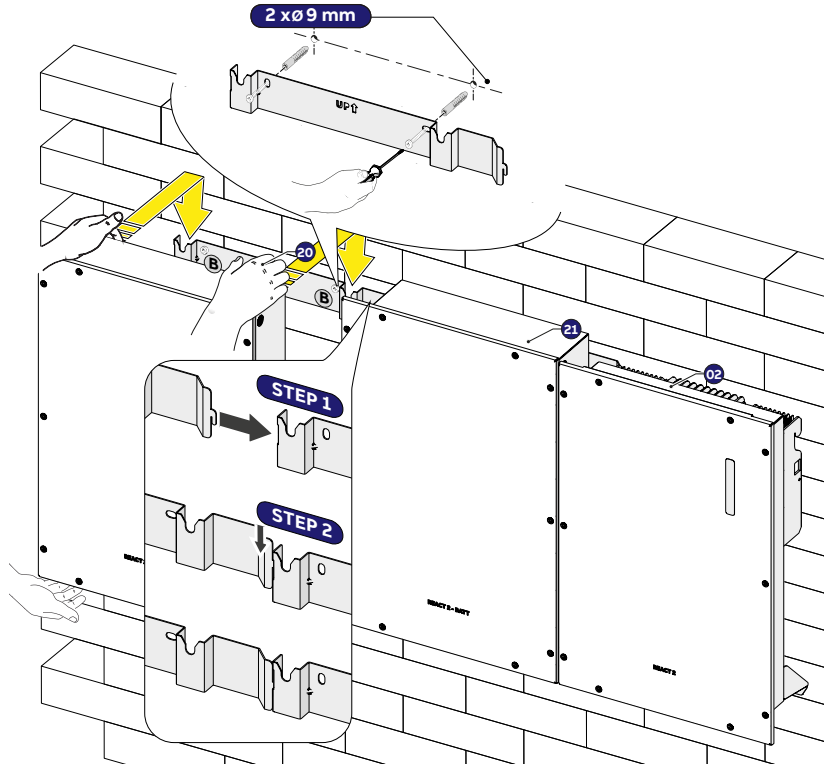

Risk of injury due to the heavy weight of the equipment.

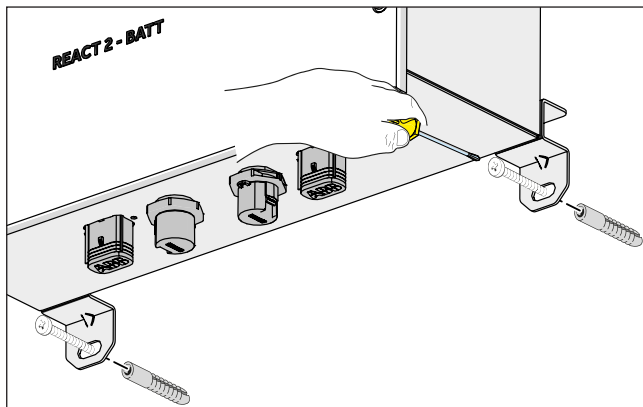

- Hang up the lower part of the REACT2-BATT to the wall using the two anchor points 26 (holes diameter 11 mm).



To avoid risks of electrical shock and battery damage (notified by E097 error), all wiring operations must be carried out with AC disconnected and DC switch in OFF position. Faulty units are considered out of warranty.

- Remove the caps from the battery connectors:
  - To remove the battery signal connectors 08 22 simply pull it.
  - To remove the battery power connectors 09 23 press the latch (highlighted in red) and pull it off.

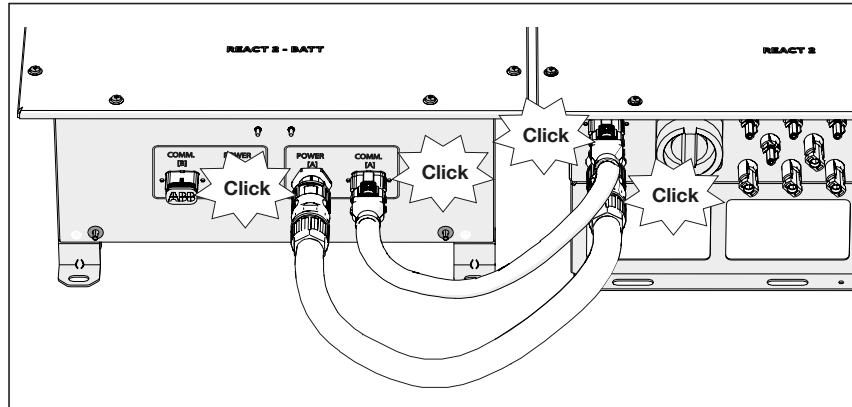

- Connect the two battery cables between inverter and battery unit (supplied inside the REACT2-BATT box).
- Give each cable a pull test to confirm the connection is secure.

- Install an earth cable between the protective grounding connection points on the two REACT2-BATTs  
 To execute all external grounding connection, follow the procedure described below:
  1. From among the components supplied, find the M5 nut, M5 flat washer and M5 serrated lock washer and two cable lugs.  
 Make a jumper earth cable using the two cable lugs supplied (minimum cross-section not less than 4mm<sup>2</sup>). The cable must be long enough to connect the REACT2-BATT external protective earth [B] 24 to the REACT2-BATT external protective earth [A] 25
  2. Connect the cable on REACT2-BATT external protective earth [B] 24 of the first REACT2-BATT installed.
  3. Connect the other side of the cable on REACT2-BATT external protective earth [A] 25
 For both connection follow the below installation sequence

**Installation sequence:**

- knurled washers
- jumper earth cable (other side)
- flat washers
- M5 nut (torque of 4.1 Nm)

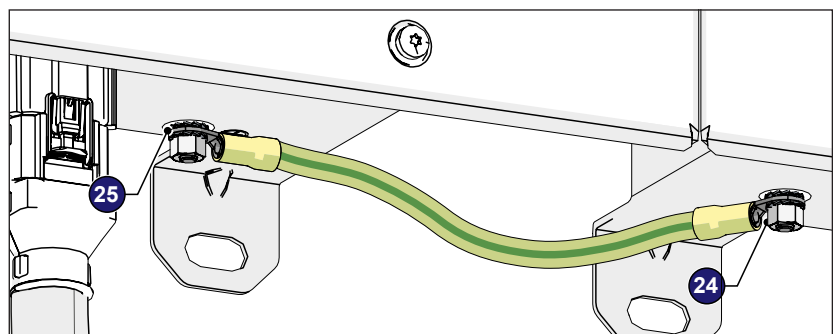

## Connection of the energy meter



*Warning – The meter must always be protected by fuses or circuit breakers on the incoming side. It is recommended that the input voltage sensing is protected by fuses rated 6A (gL–gG type) or by circuit breakers rated 6A (B/C type) installed near the meter.*



*To avoid risks of electrical shock, all wiring operations must be carried out with the AC disconnect switch (or the supply meter) upstream of the meter disconnected.*



*The indications set out below are necessary to connect the REACT-MTR to the REACT system. Always refer to the specific documentation supplied with the REACT-MTR.*

Management of the storage system in order to optimise the energy self-consumption and self-sufficiency of the REACT2 system is based on the reading of the power by the meter. On the basis of the type of electric supply the following are available:

- REACT-MTR-1PH <sup>54</sup> for single-phase grid up to 30 A.
- FIMER B21 <sup>40</sup> for single-phase grid up to 65 A.
- FIMER B23 <sup>58</sup> for three-phase grid up to 65 A (it can be used for single-phase grid if correctly installed).
- FIMER B24 <sup>58</sup> for three-phase supplies with an external current transformer (it can be used for mono-phase supplies if correctly installed).

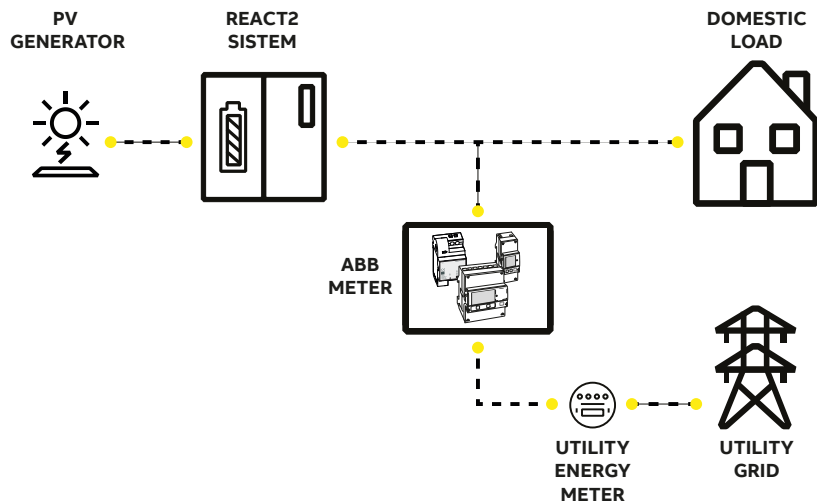

The energy meter will communicate with the REACT2 through a dedicated serial line (RS485 METER).

*If the energy meter is not installed or not communicating, the REACT2 system will manage the functions connected to energy storage in provisional mode; where power is available from the sun, REACT2 charges the battery with 300 W. The rest of the power is fed into the grid. This mode makes it possible, even if there is no meter, to charge the battery.*

The connection of the RS485 METER line to the REACT2-UNO must be

made using the dedicated METER connector <sup>14</sup>.

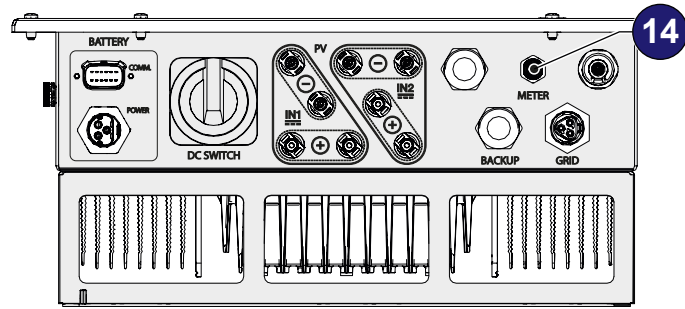

In the picture below are described the components of the counterpart connector and the relative torques:

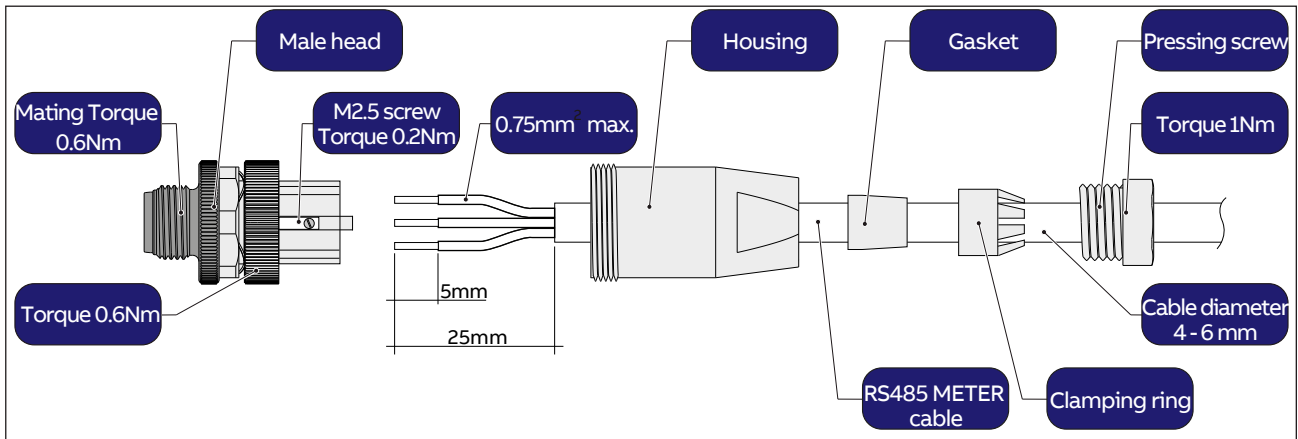

Follow the procedure to connect the RS485 cable to the counterpart (supplied) of the METER connector <sup>14</sup>:

1. Disassembly the counterpart connector
2. Install all components on the RS485 cable
3. Strip the cable as indicated in the picture
4. Install the wire on the head of the connector following the indication below:

Screw terminal on the counterpart connector	RS485 METER signal
1	-T/R
3	+T/R
4	RTN

- Turn the M2.5 screw with suitable screwdriver (torque 0.2Nm)
5. Install connector housing (torque 0.6Nm)
  6. Install seal, pinch ring, pressing screw
  7. Pressing screw should be tightened with torque 1Nm
  8. Install the counterpart on the METER connector <sup>14</sup> by screwing the metallic ferrule (torque 0.6Nm).
  9. Give each cable a pull test to confirm the connection is secure.



*The cable of the cable assembly must remain perpendicular to the connector and avoid an excessively sharp bend radius and loading. The minimum bend radius of a cable is  $\pm 10^\circ$ .*

## Connection of the REACT-MTR-1PH (single-phase)



The indications set out below are necessary to connect the REACT-MTR-1PH to the REACT2 system. Always refer to the specific documentation supplied with the REACT-MTR-1PH.

The energy meter REACT-MTR-1PH **51** is a DIN rail device (3 modules) and must be installed where the electricity supply is single-phase.



To avoid risks of electrical shock, all wiring operations must be carried out with the AC disconnect switch (or the supply meter) upstream of the REACT-MTR-1PH disconnected.

- Ensure that the AC line has been correctly disconnected upstream from the REACT-MTR-1PH. Check that there is no voltage by using a multimeter.
- Strip 8/10mm of sheathing from the connection cables of the AC power supply and connect the phase (L) and neutral (N) on the specific terminal block **53** set on the upper side of the meter; each individual terminal of the terminal block takes a cable with a maximum section from 0.5 to 4mm<sup>2</sup> (tightening torque of 0.5Nm).
- Connect the cables of the serial line (+T, -T and RTN) on the terminal block **54** (on the lower part of the REACT-MTR-1PH) respecting the correspondence between the signals of the serial line.

Serial line terminal block of the REACT-MTR-1PH <b>54</b>	Screw terminal on the counterpart connector
-T	1 (-T/R)
+T	3 (+T/R)
RTN	4 (RTN)

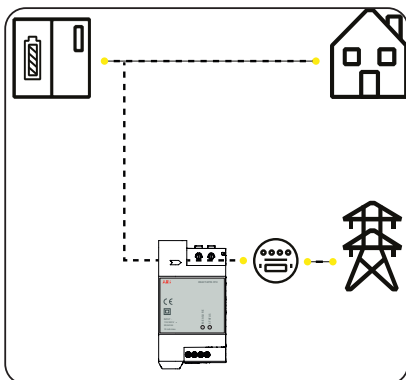
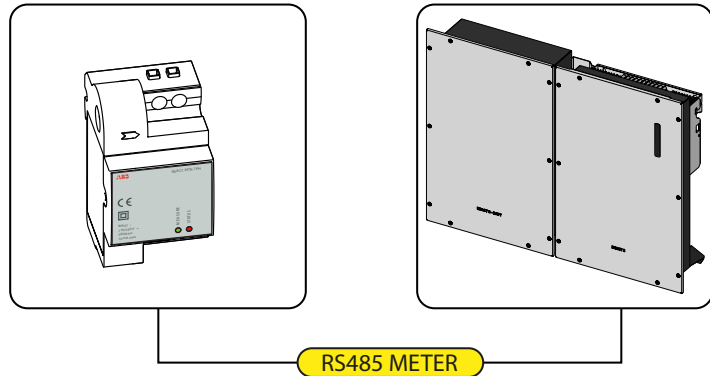

Each individual terminal of the terminal block takes a cable with a section from 0.14 to 1.5mm<sup>2</sup> (tightening torque of 0.5Nm).

- Subsequently the other side of the cable must be connected to the REACT2-UNO METER connector **14**
- Install the device on the DIN rail and ensure to trigger the fixing system on it
- Disconnect the phase cable (L) of the electric supply
- Insert the phase cable (L) through the hole (Ø8mm) on the REACT-MTR-1PH **51**. The arrow corresponding to the hole for the feeding of the line cable **52**, indicates the direction of insertion which must be complied with for correct measurement of the current; in fact the direction of the arrow indicates the supply point of the electric energy (as indicated in the diagram).

- Checks for correct meter position:

1 - Turn off DC switch of REACT 2

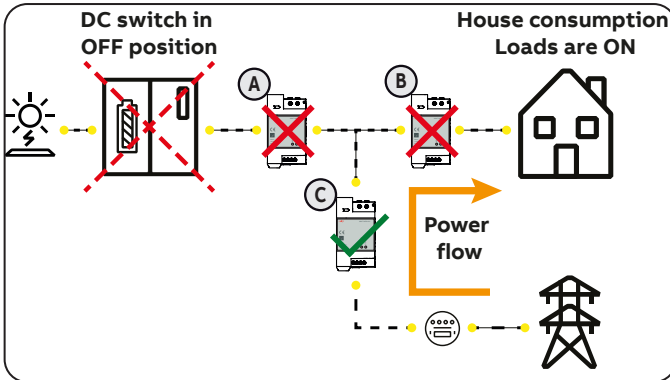

Turn off REACT 2 DC switch.  
 House consumption shall be greater than 50 W.  
 Webserver user interface shall show power coming from grid (negative value, eg: - 1250 W).  
 - If power is shown, FIMER Meter can be in position **B** or **C** (if power sign is negative go to step 2 otherwise adjust meter orientation)  
 - If No power is shown (0 W). Meter is in position **A**. Please install meter in the right place with correct orientation.

2 - Turn OFF all house loads

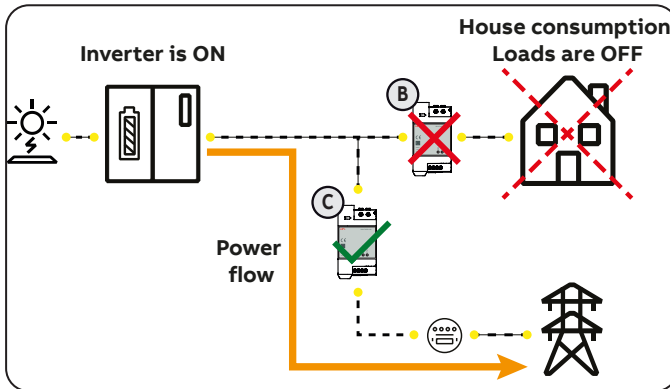

Turn ON DC switch of REACT 2  
 Turn off all the house loads.  
 Webserver user interface shall show power flow to the grid with positive value (eg: + 1000 W) or power flow to charge battery.  
 - If No Power is shown (0 W). Meter is in position **B** (WRONG). Install meter in the right one **C**.  
 - If power is shown with positive sign (red LED MEASURE is permanently ON) the meter is in the right position **C**.

Here below is set out the behaviour of LEDs on the REACT-MTR-1PH:

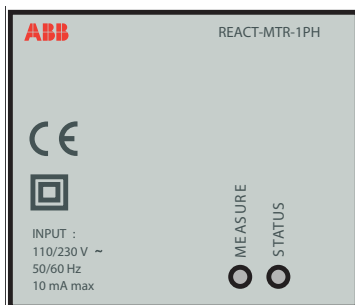

MEASURE LED	description
Permanent Green	Serial communication absent or malfunctioning
Flashing	Serial communication present

STATUS LED	description
Permanent red	Drawing of energy from the grid
Green (steady)	Self-consumption (maximum exchange $\pm 20W$ )
Flashing red and green	Feeding of energy from the grid

## Connection and configuration of the FIMER B21 meter (single-phase)



The indications set out below are necessary to connect the meter to the REACT2 system. Always refer to the specific documentation supplied with the FIMER B21.

The energy meter FIMER B21 <sup>50</sup> is a DIN rail device (2 modules) and must be installed where the electricity supply is single-phase.

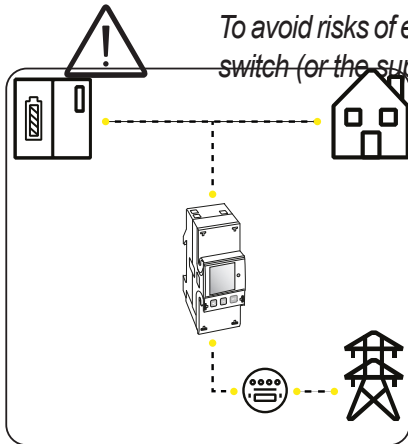

To avoid risks of electrical shock, all wiring operations must be carried out with the AC disconnect switch (or the supply meter) upstream of the meter disconnected.

- Disconnect the AC disconnect switch upstream of the meter.
- Strip the insulation of the cable for the length which is indicated on the meter (13mm).
- Connect the cables of the single-phase line in accordance with the layout printed on the meter (L and N) to the AC connection terminal block <sup>53</sup> and tighten the screws (tightening torque 3.0 Nm).
- Connect the cables of the serial line A (37), B (36) and C (37) (set on the rear of the FIMER B21 <sup>50</sup>) respecting the correspondence between the signals of the serial line and tighten the screws (torque 0.25 Nm):

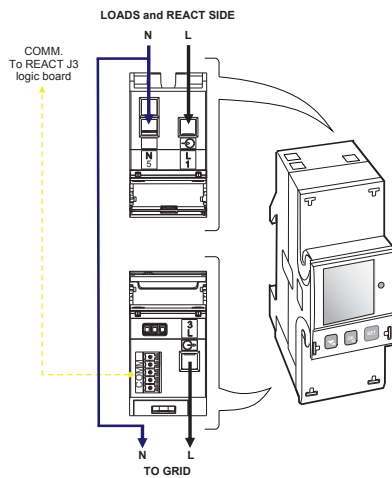

Serial line terminal block of the meter FIMER B21 <sup>54</sup>	Screw terminal on the counterpart connector
A (37)	1 (-T/R)
B (36)	3 (+T/R)
C (35)	4 (RTN)

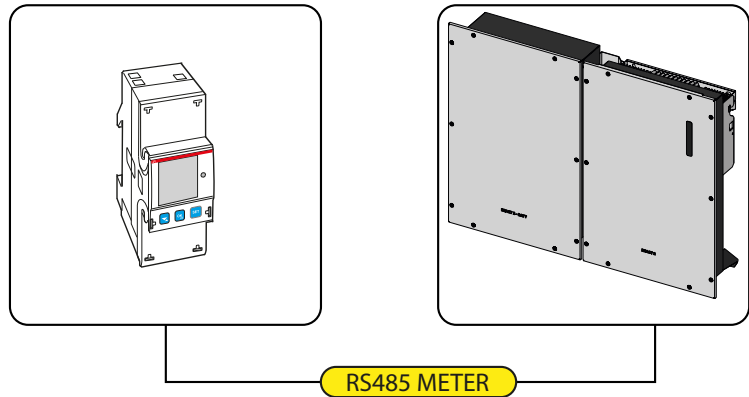

- Subsequently the other side of the cable must be connected to the REACT2-UNO METER connector <sup>14</sup>
- Install the meter on the DIN rail and ensure to trigger the fixing system on it
- Once the phase of mechanical installation of the METER is finished, it is necessary to configure the METER in order to make it compatible with the REACT2 system. Set the parameters of the meter as set out in the table:

Parameter	Settings
Address	1
Protocol	MODBUS
Baud rate	19200



Parity	EVEN
--------	------

The settings are made by using the keypad and the display on the meter:

1. Press for two seconds **OK** to access the setup menu of the meter.
2. Press repeatedly **↵** until the display shows “Set”.
  - Press **OK** to confirm.
3. Press repeatedly **↵** until the display shows “RS-485”.
  - Press **OK** to confirm.
4. Press repeatedly **↵** until the display shows “Protocol”.
  - Press **OK** to access.
  - Press **SET** to enable the change in the value.
  - Press repeatedly **↵** until the display shows “Modbus”.
  - Press **OK** to confirm the change.
  - Press for two seconds **OK** to return to the RS485 menu.
5. Press repeatedly **↵** until the display shows “Baud rate”.
  - Press **OK** to access.
  - Press **SET** to enable the change in the value.
  - Press repeatedly **↵** and select 19200.
  - Press **OK** to confirm the change.
  - Press for two seconds **OK** to return to the RS485 menu.
6. Press repeatedly **↵** until the display shows “Address”.
  - Press **OK** to access.
  - Press **SET** to enable the change in the value.
  - Press repeatedly **↵** and select 1.
  - Press **OK** to confirm the change.
  - Press for two seconds **OK** to return to the RS485 menu.
7. Press repeatedly **↵** until the display shows “Modbus”.
  - Press **OK** to access.
  - Press **SET** to enable the change in the value.
  - Press repeatedly **↵** and select even.
  - Press **OK** to confirm the change.

Checks for correct meter position

1 - Turn off DC switch of REACT 2

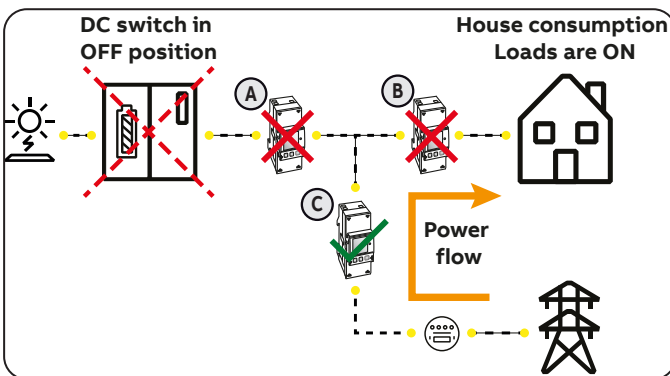

Turn off REACT 2 DC switch.

House consumption shall be greater than 50 W. Webserver user interface and meter display shall show power coming from grid (negative value, eg: -1250W).

- If power is shown, FIMER Meter can be in position **B** or **C** (if power sign is negative go to step 2 otherwise adjust meter orientation)
  - If No power is shown (0 W). Meter is in position **A**.
- Please install meter in the right place with correct orientation.

2 - Turn OFF all house loads

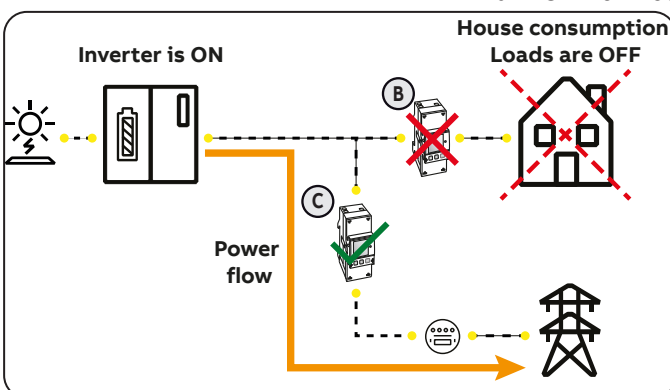

Turn ON DC switch of REACT 2

Turn off all the house loads.

Webserver user interface shall show power flow to the grid with positive value (eg: +1000 W) or power flow to charge battery.

- If No Power is shown (0 W). Meter is in position **B** (WRONG). Install meter in the right one **C**.
- If power is shown with positive sign the meter is in the right position **C**.

## Connection and configuration of the REACT-MTR-3PH (three-phase)



The indications set out below are necessary to connect the meter to the REACT2 system. Always refer to the specific documentation supplied with the meter.

The energy meter <sup>55</sup> is a DIN rail device (4 modules) and must be installed where the electricity supply is three-phase.



To avoid risks of electrical shock, all wiring operations must be carried out with the AC disconnect switch (or the supply meter) upstream of the meter disconnected.

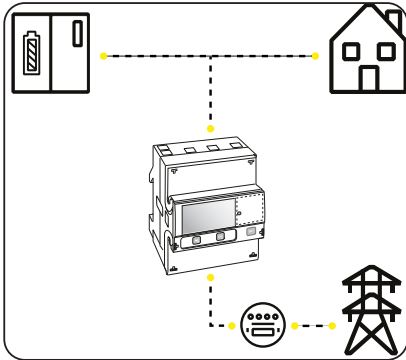

- Disconnect the AC disconnect switch upstream of the meter.
- Strip the insulation of the cable for the length which is indicated on the meter (13mm).
- Connect the cables of the three-phase line in accordance with the layout printed on the meter (L1, L2, L3 and N) to the three-phase connection terminal block <sup>56</sup> and tighten the screws (tightening torque 2.0 Nm).



Take note of the phase to which the REACT2 system is connected; this information will be requested when the system is commissioned.

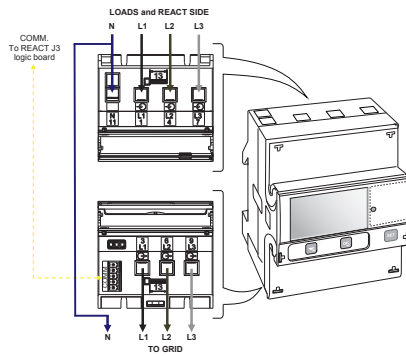

- Connect the cables of the serial line A(37), B(36) and C(37) on the terminal block <sup>57</sup> set on the rear of the meter <sup>55</sup> respecting the correspondence between the signals of the serial line and tighten the screws (torque 0.25 Nm) and tighten the screws (tightening torque 0.25 Nm):

Serial line terminal block of the meter FIMER B23, B24 <sup>60</sup>	Screw terminal on the counterpart connector
A (37)	1 (-T/R)
B (36)	3 (+T/R)
C (35)	4 (RTN)

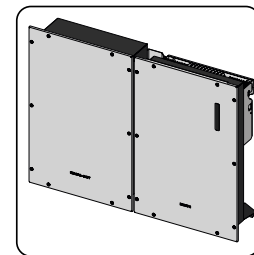
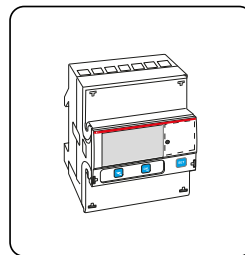





























RS485 METER

- Subsequently the other side of the cable must be connected to the REACT2-UNO METER connector <sup>14</sup>
- Install the device on the DIN rail and ensure to trigger the fixing system on it
- Once the phase of mechanical installation of the METER is finished, it is necessary to configure the METER in order to make it compatible with the REACT2 system. Set the parameters of the meter as set out in the table:

Parameter	Settings
Address	1
Protocol	MODBUS
Baud rate	19200
Parity	EVEN

The settings are made by using the keypad and the display on the meter:

1. Press for two seconds  to access the setup menu of the meter.
2. Press repeatedly  until the display shows "Set".
  - Press  to confirm.
3. Press repeatedly  until the display shows "RS-485".
  - Press  to confirm.
4. Press repeatedly  until the display shows "Protocol".
  - Press  to access.
  - Press  to enable the change in the value.
  - Press repeatedly  until the display shows "Modbus".
  - Press  to confirm the change.
  - Press for two seconds  to return to the RS485 menu.
5. Press repeatedly  until the display shows "Baud rate".
  - Press  to access.
  - Press  to enable the change in the value.
  - Press repeatedly  and select 19200.
  - Press  to confirm the change.
  - Press for two seconds  to return to the RS485 menu.
6. Press repeatedly  until the display shows "Address".
  - Press  to access.
  - Press  to enable the change in the value.
  - Press repeatedly  and select 1.
  - Press  to confirm the change.
  - Press for two seconds  to return to the RS485 menu.
7. Press repeatedly  until the display shows "Modbus".
  - Press  to access.
  - Press  to enable the change in the value.
  - Press repeatedly  and select even.
  - Press  to confirm the change.

Checks for correct meter position

1 - Turn off DC switch of REACT 2

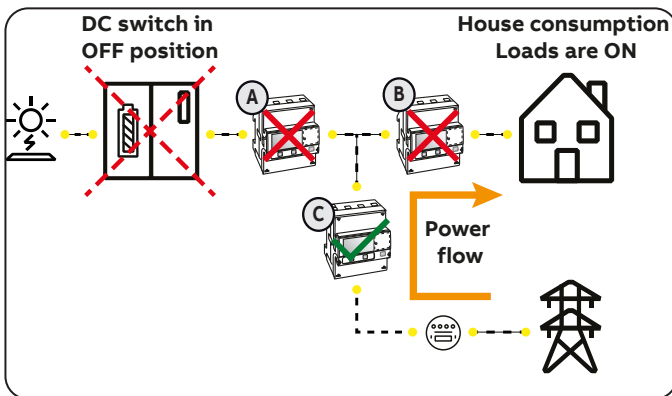

Turn off REACT 2 DC switch.

House consumption shall be greater than 50 W.

Webserver user interface and meter display shall show power coming from grid (negative value, eg: - 1250 W).

- If power is shown, FIMER Meter can be in position **B** or **C** (if power sign is negative go to step 2 otherwise adjust meter orientation)

- If No power is shown (0 W). Meter is in position **A**. Please install meter in the right place with correct orientation.

2 - Turn OFF all house loads

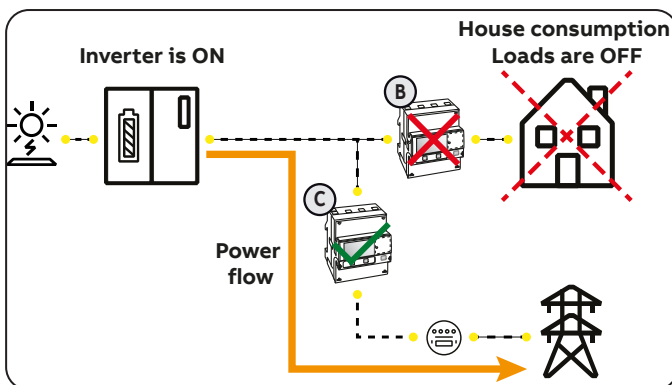

Turn ON DC switch of REACT 2

Turn off all the house loads.

Webserver user interface shall show power flow to the grid with positive value (eg: + 1000 W) or power flow to charge battery.

- If No Power is shown (0 W). Meter is in position **B** (WRONG). Install meter in the right one **C**.

-If power is shown with positive sign the meter is in the right position **C**.

## Distribution grid output connection (AC side)

To connect the inverter to the grid you need 4 connections: ground, neutral, phase and external grounding protection **In any case, connection of the inverter to ground is mandatory.**



*Any failure of the inverter when it is not connected to ground through the appropriate terminal (AC connector) and to the metal frame (external grounding protection) is not covered by the warranty.*

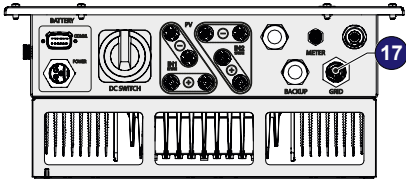

The connection of the grid cable to the inverter is realised through the dedicated AC output connector 17 by carrying out the following operations:

- Characteristics and sizing of the line cable
- Installation of the cable on the AC output connector counterpart
- Connection of the AC output connector to the inverter

### Characteristics and sizing of the line cable

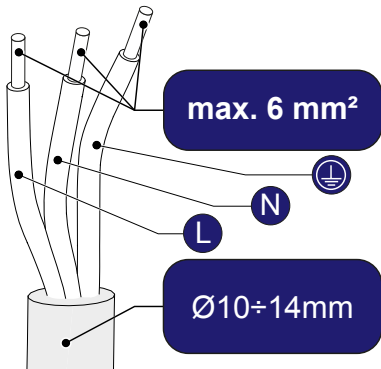

The cross-section of the AC line conductor must be sized in order to prevent unwanted disconnections of the inverter from the grid due to high impedance of the line that connects the inverter to the power supply; If the impedance is too high it causes an increase in the AC voltage which, on reaching the limit set by the standards in the country of installation, causes the inverter to switch off.

In order to allow installation of the grid cable inside the AC output connector 17, the sizings indicated in the figure must be observed.

The table shows the maximum line conductor length in relation to the section of the conductor itself:

Line conductor cross section (mm <sup>2</sup> )	Line conductor maximum length (m)	
	REACT2-UNO-3.6	REACT2-UNO-5.0
1.5	5 m	/
2.5	10 m	6 m
4	16 m	10 m
6	24 m	16 m



*The values are calculated in nominal power conditions, considering:*

- loss of power along the line no greater than 1%
- use of copper cable, with HEPR rubber insulation and positioned in open air

## Load protection switch (AC disconnect switch)

To protect the inverter and the AC connection line, a device must be installed to protect against maximum current and leakage to ground, with the following characteristics:

	REACT2-UNO-3.6	REACT2-UNO-5.0
Type	Automatic circuit breaker with thermal-magnetic protection	
Voltage rating	230 Vac	
Current rating	25 A	32 A
Magnetic protection characteristic	B/C	

In case of installation of a residual current protection device must meet the following characteristics:

	REACT2-UNO-3.6	REACT2-UNO-5.0
Differential protection type	A/AC	
Differential sensitivity	300 mA	
Number of poles	2	

## Installation of the cable on the AC output connector



To avoid risks of electrical shock, all wiring operations must be carried out with the disconnect switch downstream of the inverter (grid side) opened and applying LOTO procedure on it.

- Remove the head of the connector by pressing on the two holding clips and subsequently loosen the cable gland.

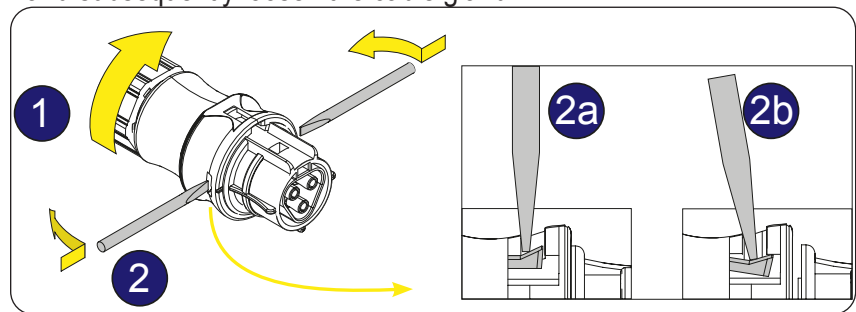

- Feed the cable through the connector and cut the cable to size. Ensure that the cable's radius of curvature is more than 4 times the diameter of the cable.

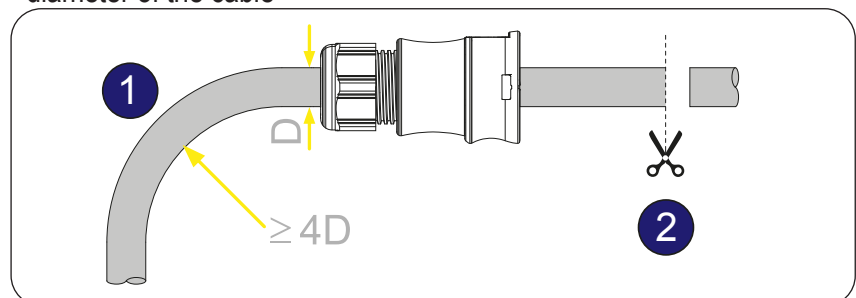

- Prepare the cable respecting the following measurements. It's possible to

use both stranded or solid wire but the requirements are different.

The use of stranded wire with a conductor section values between 1.5 - 4 mm<sup>2</sup> are only allowed with the mandatory use of properly crimped ferrules.

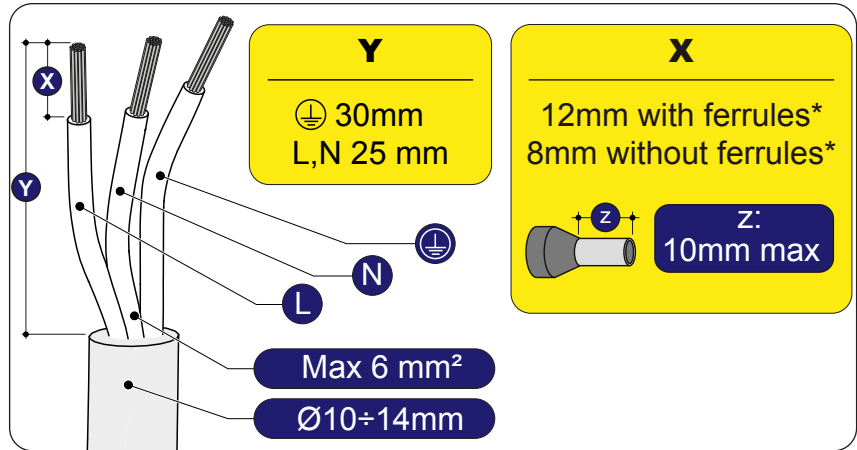

- Install the single wires (phase, neutral and ground) on the head of the connector respecting the indications printed on each of the three connection terminals (tightening torque 0.8...1Nm)

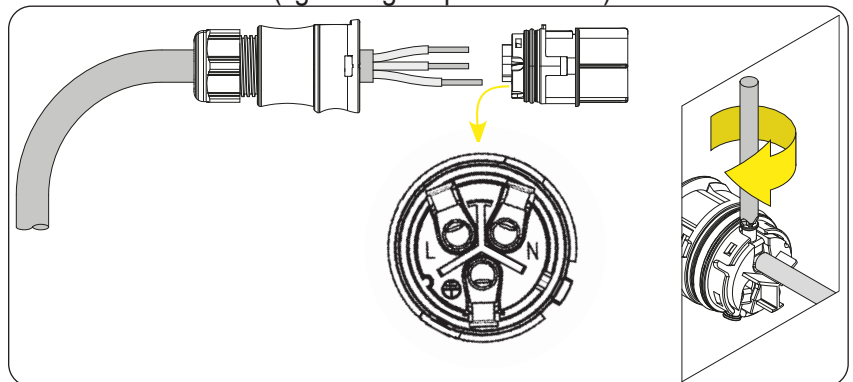

- Close the connector and tighten the cable gland respecting the tightening torque (4+1Nm) in order to guarantee the IP65 protection level

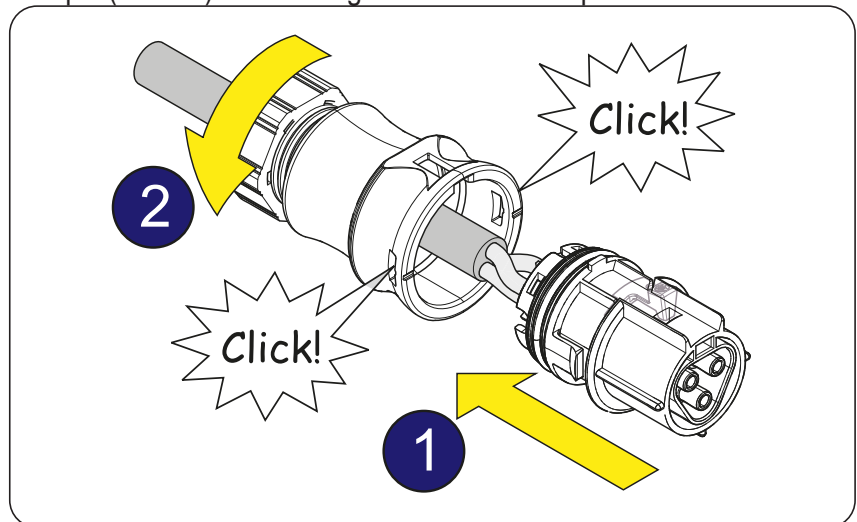

## Connection for the AC output connector to the inverter



To avoid risks of electrical shock, all wiring operations must be carried out with the disconnect switch downstream of the inverter (grid side) opened and applying LOTO procedure on it.

For all inverter models, connection to the electrical grid is carried out using the AC output connector ⑰.

1. Remove the pre-installed protective cover on the inverter by pressing on the the latch with a flat screwdriver.
2. Insert the counterpart in the AC output (GRID) connector ⑰ being careful to align the reference points (present on both connectors) which prevent connection errors.
3. Push the counterpart until you hear “click”
4. Give a pull test to confirm the connection is secure.

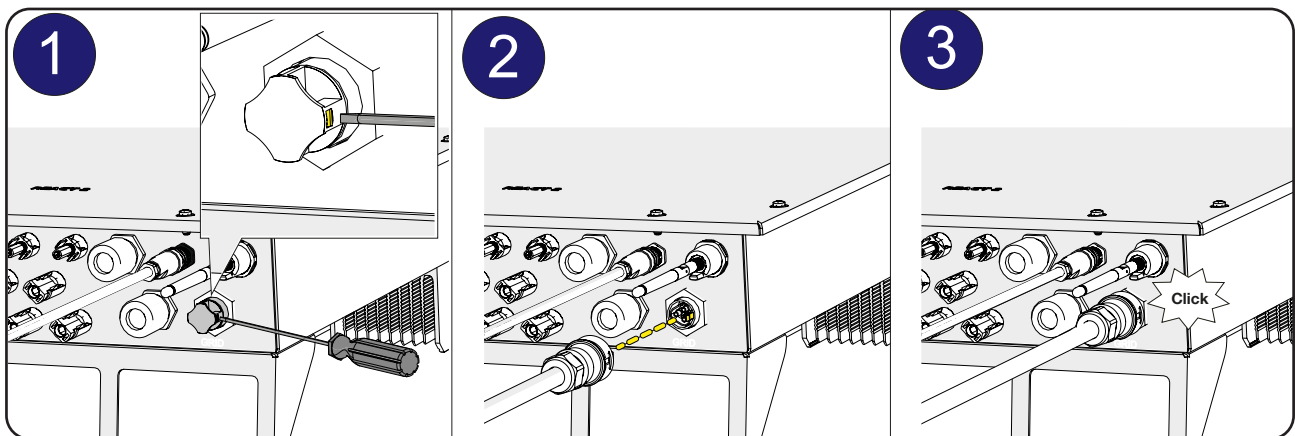

In addition, the connector must not be subject to tensile forces (examples: do not connect weights to the AC cable, do not leave excess cable windings hanging, etc).



In order to maintain the inverter's level of IP protection, the corresponding part must be installed with the AC cable connected or the protective cover, on the AC output connector.

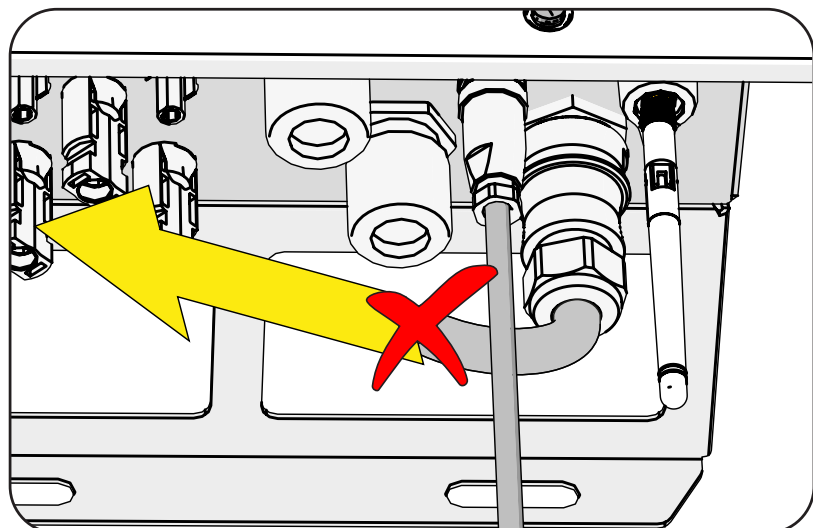

## Installation of the external protective grounding cable

In addition to the grounding protection previously connected to the AC output connector 17 is necessary to:

- install a second protective grounding cable to the dedicated connection point on the metal frame (lower part) of the REACT2-UNO.
- install a jumper between the protective grounding connection points on REACT2-UNO and REACT2-BATT

To execute all external grounding connection, follow the procedure described below:

1. Make a jumper earth cable using the two cable lugs supplied (minimum cross-section not less than 4mm<sup>2</sup>). The cable must be long enough to connect the REACT2-UNO external protective earth 11 to the REACT2-BATT external protective earth [A] 25.
2. Fit a proper cable lug on the protective earth cable (minimum cross-section not less than the phase cable and in any case not less than 4mm<sup>2</sup>).
3. From among the components supplied, find the M5 nut, M5 flat washer and M5 serrated lock washer.
4. Install the earth cables following the below installation sequence

### Installation sequence:

- knurled washers
- external protective earth cable
- jumper earth cable
- flat washer
- M5 nut (torque of 4.1 Nm)

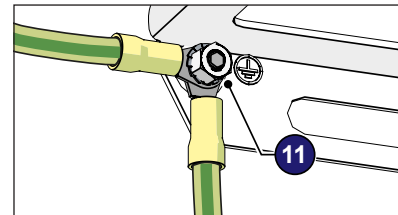

5. Connection on REACT2-BATT external protective earth [A] 25.  
Follow the below installation sequence

### Installation sequence:

- knurled washers
- jumper earth cable
- flat washer
- M5 nut (torque of 4.1 Nm)

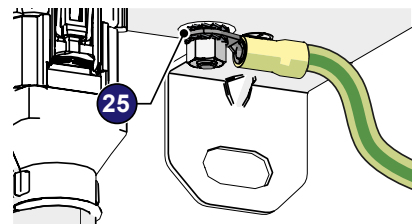

The below illustration shown the installation of all external PE connection.

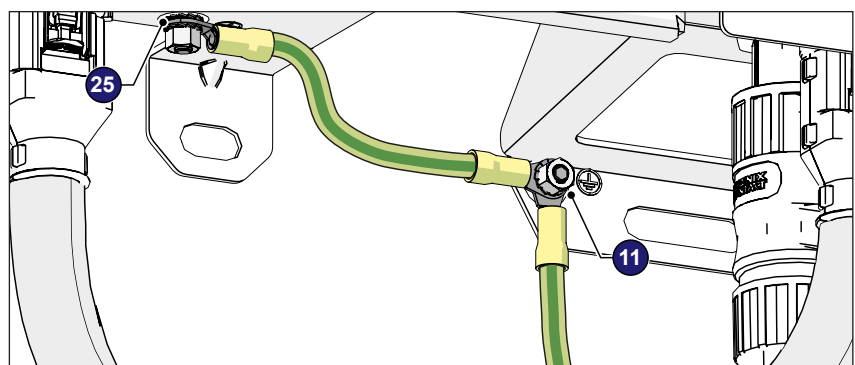



## BACKUP output connection (AC)

To connect the BACKUP output of the inverter, 3 connections are necessary: ground, neutral and phase. **In any case, connection of the inverter to ground is mandatory.**



*Any failure of the inverter when it is not connected to ground through the appropriate terminal (AC connector) and to the metal frame (external grounding protection) is not covered by the warranty.*



*The BACKUP output must never be connected to the public power supply, but only have dedicated loads isolated from the grid.*

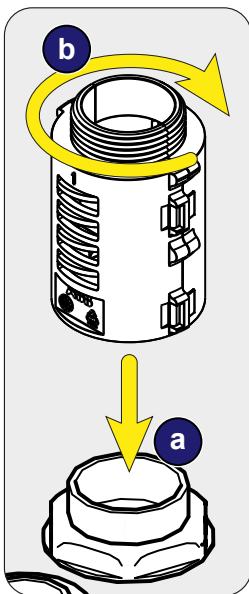

Install the filter (supplied with the inverter) on the internal side of AC output (BACKUP) cable gland **16** (side inside the REACT2-UNO).

The installation is carried out:

- **a** position the filter on the internal side of the cable gland
- **b** Screw the filter on the thread of the cable gland

Insert the backup cable into the REACT2 using the AC output (BACKUP) cable gland **16** (M25 with toroid) and make the connections to the AC output (BACKUP) screw terminal block **42**.

Use a properly sized tripolar cable and check the tightness of the AC output (BACKUP) cable gland **16** at the end of the installation.

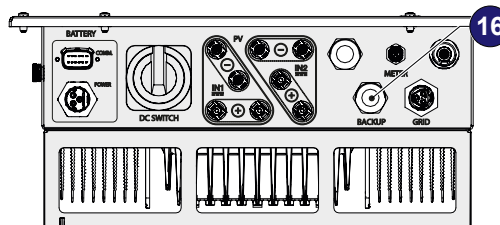

The REACT2 system is equipped with an AC BACKUP output that can be activated in different 2 ways:

### - Backup Mode: AUTO

Automatic activation in case of loss of main (blackout).

### - Backup Mode: External Control

An External command/signal is used for activating the output (Communication and control signal terminal block **16**, terminal 1-3).

The selection of the backup mode is performed during the commissioning wizard.



See the “REACT2-Backup output use” document on the FIMER site for more information

## Characteristics and sizing of the cable for BACKUP output

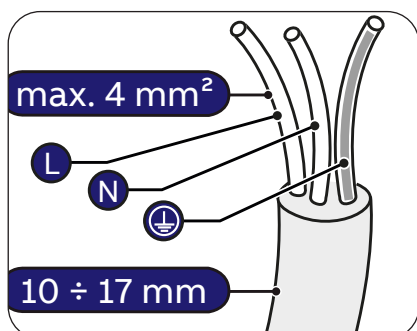

Three-pole cable required. The cross-section of the AC line conductor must be sized in order to prevent unwanted disconnections of the inverter from the grid due to high impedance of the line that connects the inverter to the power supply point.

The table shows the maximum length of the line conductor based on the cross-section of this conductor:

Conductor cross-section of line (mm <sup>2</sup> )	Maximum length of the line conductor (m)
1.5	6 m
2.5	11 m
4	19 m

The values are calculated in nominal power conditions, considering:

- loss of power along the line no greater than 1%
- use of copper cable, with HEPR rubber insulation and positioned in open air

## Load protection switch (AC disconnect switch) for BACKUP output

To protect the AC BACKUP connection line of the inverter, a device must be installed to protect against maximum current and leakage to ground, with the following characteristics:

	REACT2-3.6-TL	REACT2-5.0-TL
Type	Automatic circuit breaker with differential thermal magnetic protection	
Voltage rating	230 Vac	
Current rating	32 A	
Magnetic protection type	B/C	
Type of differential protection	A/AC	
Differential sensitivity	30 mA	
Number of poles	2	

## Connection to AC BACKUP output terminal block



**To avoid risks of electrical shock, all wiring operations must be carried out after the Inverter switch-off.**

Strip 10mm of sheathing from the cables and then insert into the inverter the cable, making it pass through the AC output (BACKUP) cable gland **16**; the maximum diameter of the cable accepted by the cable gland is from 10 to 17 mm<sup>2</sup>.

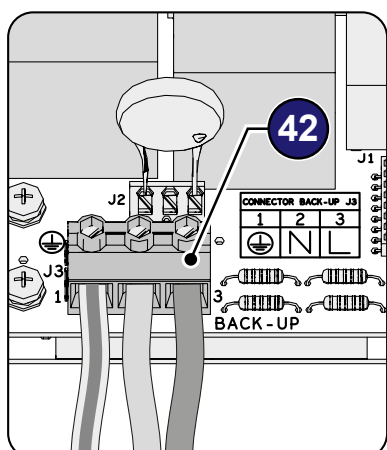

Connect on the AC output (BACKUP) screw terminal block **42** the ground cable (yellow-green) to protect against contact marked by the symbol  $\perp$ , the neutral cable (usually blue) to the terminal marked by the letter **N** and the phase cable to the terminal marked by the screen-print **L**; every individual terminal of the terminal block accepts a cable with maximum section of 4 mm<sup>2</sup> (It is necessary to fix the AC cables to the terminal block with a tightening torque of at least 1,5 Nm).

Once the connection to the terminal block has been made, firmly screw the cable gland (7.5 Nm tightening torque) and check the tightness.

## Preliminary operations for connection of the PV generator

### Checking the correct polarity of the strings

Using a voltmeter, check that the voltage of each string has the correct polarity and falls within the input voltage limits of the inverter (see technical data).



*Polarity inversion can cause serious damage.*

If the open circuit voltage of the string is near the maximum value accepted by the inverter, consider that low ambient temperatures cause an increase in the string voltage (different according to the photovoltaic module used). In this case it is necessary to carry out a check of the sizing of the system and/or a check on the connections of the modules of the system (e.g.: number of modules in series higher than the design number).

*A configuration program that can help to correctly size the photovoltaic system is available on the FIMER website <http://stringsizer.fimer.com>.*

### Checking of leakage to ground of the photovoltaic generator

Measure the voltage present between the positive and negative pole of each string with respect to ground, as described in the section on "Verification of leakage to ground".

*Do not connect the strings if a leakage to ground has been detected, as the inverter might not connect to the grid.*



### Selection of differential protection downstream of the inverter

All FIMER string inverters marketed in Europe are equipped with a device for protection against ground faults in accordance with the safety standard IEC 62109-2, sections 4.8.2 and 4.8.3 of the Standard (equivalent to Standard DIN V VDE V 0126-1:2006, section 4.7). In particular, FIMER inverters are equipped with a redundancy on the reading of the ground leakage current sensitive to all components of both direct and alternating current. Measurement of the ground leakage current is carried out at the same time and independently by 2 different processors: it is sufficient for one of the two to detect an anomaly to trip the protection, with consequent disconnection from the grid and stopping of the conversion process.

There is an absolute threshold of 300 mA of total leakage current AC+DC with protection tripping time at a max. of 300 msec.

In addition, there are another three tripping levels with thresholds respectively at 30 mA/sec, 60 mA/sec and 150 mA/sec to cover the "rapid" changes in fault current induced by accidental contact with leaking live parts. The max. tripping times are progressively shortened as the speed of change in the fault current increases and, starting from the 300 msec/

max for the 30 mA/sec change, they are shortened respectively to 150 msec and 40 msec for 60 mA and 150 mA changes.

It should in any case be noted that the integrated device only protects the system against ground faults that occur upstream of the AC terminals of the inverter (namely towards the DC side of the photovoltaic system and consequently towards the photovoltaic modules). The leakage currents that can occur in the AC section between the draw/feed and the inverter are not detected and require an external protection device.

**For protection of the AC line**, on the basis of the information above with regard to the differential protection integrated in **FIMER** inverters, **it is not necessary to install a type B differential switch**.

*In accordance with article 712.413.1.1.1.2 of Section 712 of IEC Standard 64-8/7, we hereby declare that, because of their construction, FIMER inverters do not inject ground fault direct currents.*



*The use of an AC type circuit breaker with differential thermal magnetic protection with tripping current of 300 mA is advisable so as to prevent false tripping, due to the normal capacitive leakage current of photovoltaic modules.*



*In the case of systems which consist of several inverters connected to a single switch with differential protection it is recommended that a device is installed which allows the adjustment of the tripping value and the tripping time.*

## Configuration of independent or parallel input channels

All versions of the inverter are equipped with two input channels (therefore with double maximum power point tracker MPPT) independent of each other, which can however be connected in parallel using a single MPPT.

Each channel must be connected with strings of PV modules having the same type and number of panels in series; they must also have the same installation conditions (in terms of orientation and inclination).

When connecting the two input channels in parallel, you must comply with the above requirements in order to benefit from the ability to leverage the full power of the inverter output on a single channel.

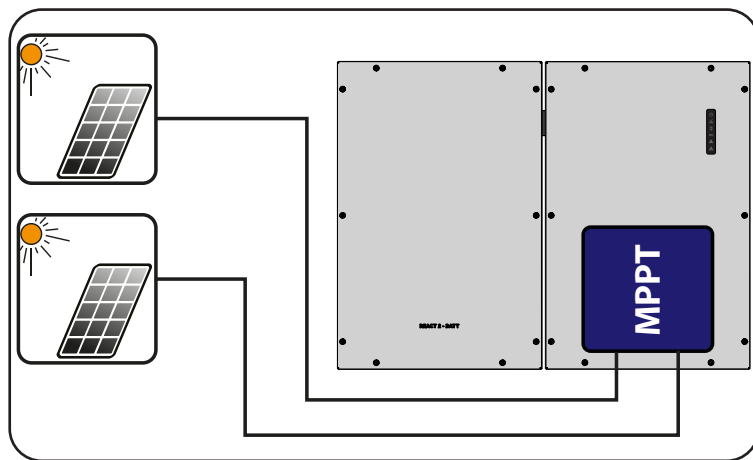

The dual MPPT structure however allows management of two photovoltaic generators which are independent of each other (one for each input channel), and which may differ between themselves with regard to installation conditions, type and number of photovoltaic modules connected in series. A necessary condition for the two MPPT to be used independently is that the photovoltaic generator connected to each of the inputs has a lower power than the power limit of the single input channel and a maximum current lower than the current limit of the single input channel.

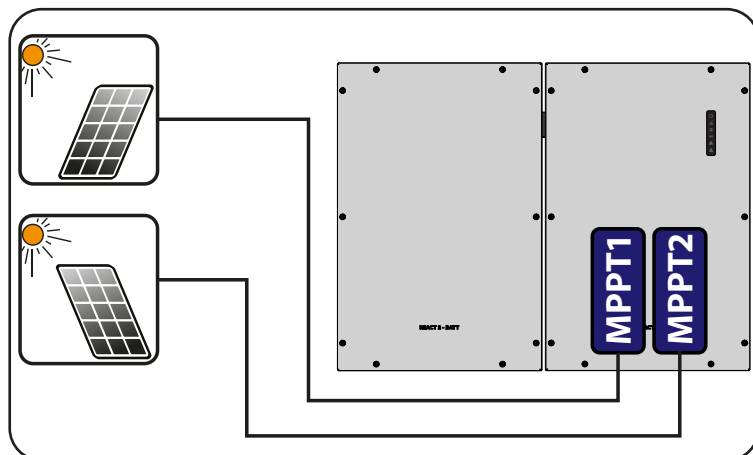

*All input parameters that must be met for correct inverter operation are shown in the “technical data” table.*

## Channel configuration examples

Characteristics of PV generator	MPPT configuration	Notes
<p>The photovoltaic generator is made up of strings with <b>differing</b> series modules numbers.</p> <p>The photovoltaic generator is made up of strings which have installation conditions which are <b>different</b> to each other.</p>	MPPT configuration <b>has to be INDEPENDENT</b>	A <b>NECESSARY</b> condition for the two MPPT to be used independently is that the photovoltaic generator connected to each of the inputs has a <b>lower</b> power than the power limit of the single input channel <b>AND</b> a maximum current <b>lower</b> than the current limit of the single input channel.
<p>The photovoltaic generator is made up of strings with <b>identical</b> series modules numbers.</p> <p>The photovoltaic generator is made up of strings which have the <b>same</b> installation conditions, that is, all the strings have the <b>same</b> inclination angle in relation to the horizontal plane and the <b>same</b> orientation to SOUTH.</p> <p>The photovoltaic generator connected to each of the inputs has a <b>lower</b> power than the power limit of the single input channel <b>AND</b> a maximum current <b>lower</b> than the current limit of the single input channel.</p>	<p>Possibility of choosing between the configuration with <b>INDEPENDENT MPPT or PARALLEL</b></p>	<p>A <b>NECESSARY</b> condition for the two MPPT to be used independently is that the photovoltaic generator connected to each of the inputs has a <b>lower</b> power than the power limit of the single input channel <b>AND</b> a maximum current <b>lower</b> than the current limit of the single input channel. An <b>ADVISABLE</b> condition (*) in order that the two MPPT may be parallel, is that the photovoltaic generator connected to the two inputs is made up of strings created from the <b>same</b> number of modules in series and that all the modules have the <b>same</b> installation conditions.</p>
(*) The condition is advisable from a system energy production viewpoint, not from the point of view of the operation of the inverter.		
<p>The photovoltaic generator is made up of strings with <b>identical</b> series modules numbers.</p> <p>The photovoltaic generator is made up of strings which have the <b>same</b> installation conditions, that is, all the strings have the <b>same</b> inclination angle in relation to the horizontal plane and the <b>same</b> orientation to SOUTH.</p> <p>The photovoltaic generator connected to each of the inputs has a <b>greater</b> power than the power limit of the single input channel <b>OR</b> a maximum current <b>greater</b> than the current limit of the single input channel.</p>	MPPT configuration <b>PARALLEL</b> mandatory	<p>A <b>SUFFICIENT</b> condition (*) for the two MPPT to be used in parallel is that the photovoltaic generator connected to each of the inputs has a <b>higher</b> power than the power limit of the single input channel <b>OR</b> a maximum current <b>greater</b> than the current limit of the single input channel. An <b>ADVISABLE</b> condition (**) in order that the two MPPT may be parallel, is that the photovoltaic generator connected to the two inputs is made up of strings created from the same number of modules in series and that all the modules have the same installation conditions.</p>
(*) The condition is sufficient from a system energy production viewpoint, not from the point of view of operation of the inverter.		
(**) The condition is advisable from a system energy production viewpoint, not from the point of view of operation of the inverter.		

## Independent channel configuration (default configuration)

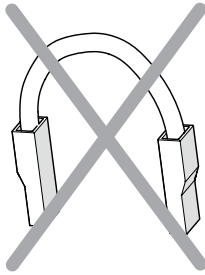

This configuration uses the two input channels (MPPT) independently.

This means that the jumper (supplied) between the positive poles of the DC (IN1 and IN2) connectors <sup>32</sup> must not be installed and that the mode which must be selected during the guided setup for commissioning the system is "INDEPENDENT".

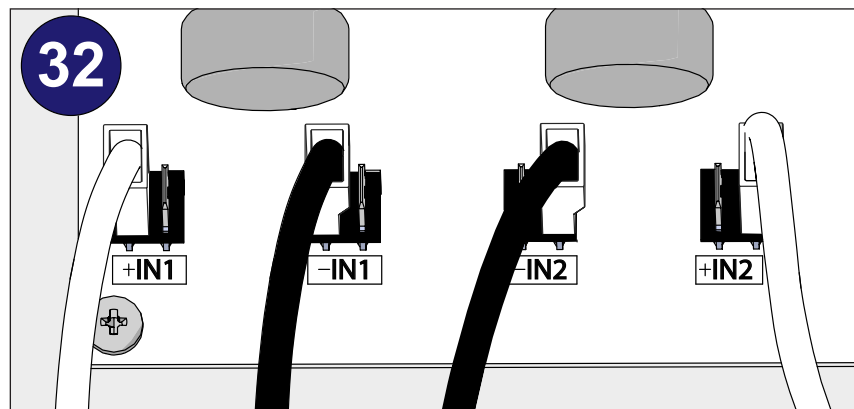

## Configuration of parallel-connected channels

This configuration uses the two input channels (MPPT) connected in parallel. This means that the jumper (supplied) between the positive poles of the DC (IN1 and IN2) connectors <sup>32</sup> must be installed and that the mode which must be selected during the guided setup for commissioning the system is "PARALLEL".

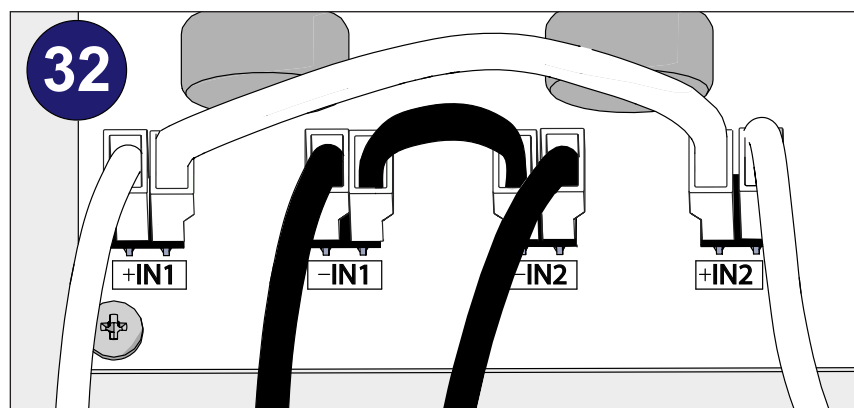

## Input connection to PV generator (DC side)

Once preliminary checks have been carried out and no problems found with the photovoltaic system, and the channel configuration has been selected (parallel or independent) you may connect the inputs to the inverter.



*Check for correct polarity in the input strings and absence of any leakage to ground in the PV generator. When exposed to sunlight, the PV panels supply DC direct voltage to the inverter. The inside of the inverter may only be accessed after the equipment has been disconnected from the grid and from the photovoltaic generator.*



*Warning! The inverters to which this document relates to are WITHOUT ISOLATION TRANSFORMER (transformer-less). This type involves the use of insulated photovoltaic panels (IEC61730 Class A Rating) and the need to maintain the photovoltaic generator floating with respect to earth: no pole of the generator must be connected to earth.*

*To avoid risks of electrical shock, all wiring operations must be carried out with the DC disconnect switch internal and external (if present, applying LOTO procedures on it) to OFF position and with the external AC disconnect switch to OFF position (applying LOTO procedures on it).*

For the connections of the strings the quick fit connectors (one for each pole of each string) located on the lower side of the REACT2-UNO are used.

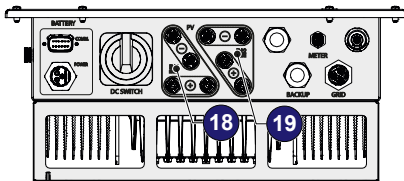

- Connect all the strings required by the system, always checking the seal of the connectors.  
The number of connections for each input channel is 2 pairs of connectors.
- Give a pull test to confirm the connection is secure.



*Connect directly the individual input strings to the REACT2-UNO. Should it be necessary to make parallel strings outside the inverter, the maximum current allowed by the individual quick fit connector must be respected, which is 18A.*



*Polarity inversion can cause serious damage. Check polarity before connecting each string! According to the system configuration, check the correct setting of the channels to independent or in parallel mode. An incorrect setting of the input channels can lead to loss of energy production.*

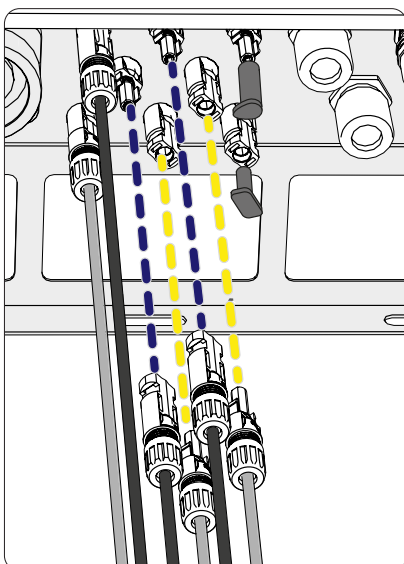

- If any string inputs are not required, you must ensure that covers are installed to the connectors, and install any which are missing. This is necessary both for the inverter grade IP seal, and to avoid damage to the free connector which may be used at a later time.



## Installation procedure for quick-fit connectors

In the inverter models, where the quick-fit connectors are used, is possible to find one of the following four types:

- Weidmüller PV-Stick
- Weidmüller WM4
- MultiContact MC4
- Amphenol H4.

Please refer to the document “*String inverters – Product manual appendix*” available at [www.fimer.com](http://www.fimer.com) for information on the quick-fit connector brand and model used in the inverter.

The model of connectors installed on your inverter must be matched by the same model of the respective corresponding parts to be used (checking the conforming corresponding part on the manufacturer's website or with FIMER).



Using corresponding parts that are not compliant with the quick-fit connector models on the inverter could cause serious damage to the unit and lead to invalidation of the warranty.



**CAUTION:** To avoid damage to the equipment, when attaching cables, pay particular attention to polarity.

### 1. WEIDMÜLLER PV-Stick quick-fit connectors

Installation of Weidmüller PV-Stick connectors does not require any special tooling.

- Strip the cable to which you want to apply the connector (after verifying that it complies with the connector limits).

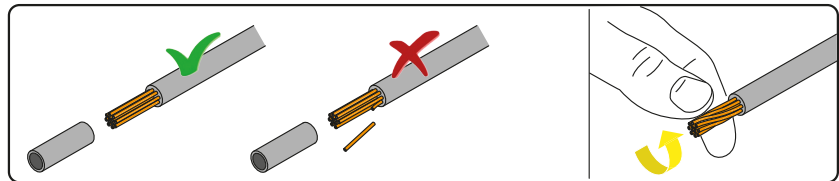
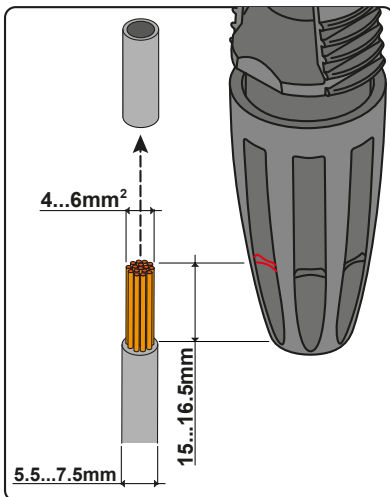

- Insert the wire into the connector until you hear a locking "click".

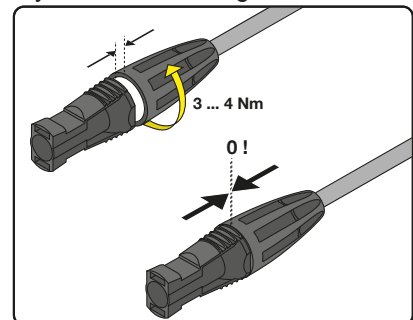
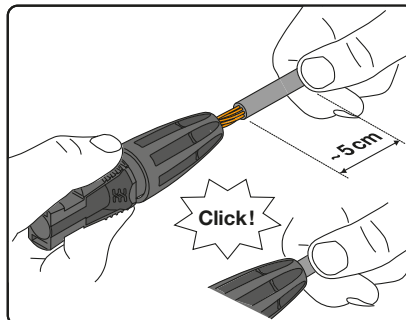

- Tighten the knurled ring nut for optimal clamping.

## 2. WEIDMÜLLER WM4 quick-fit connectors

Installation of Weidmüller WM4 connectors requires crimping to be carried out with suitable equipment.

- Strip the cable to which you want to apply the connector (after verifying that it complies with the connector limits).

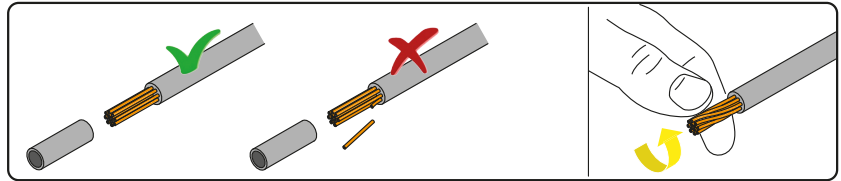
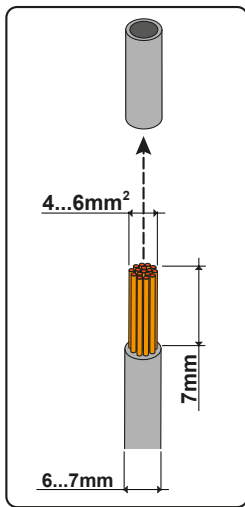

- Apply the terminal to the conductor using the designated pliers.

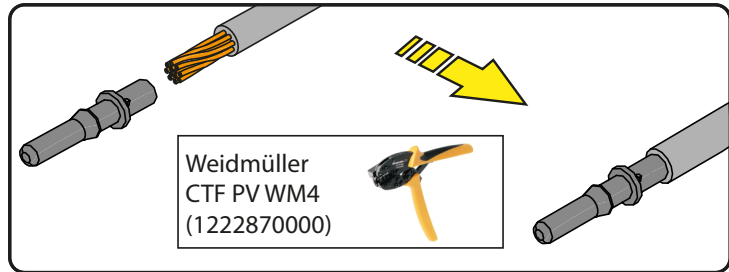

- Insert the cable with the terminal into the interior of the connector, until you hear the click indicating that the terminal is locked inside the connector.

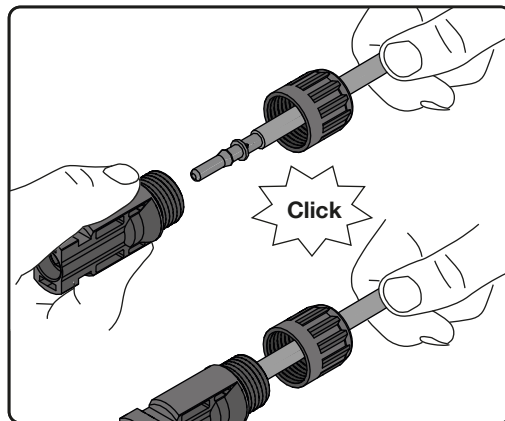

- Firmly tighten the cable gland using the relevant tool to finish the operation.

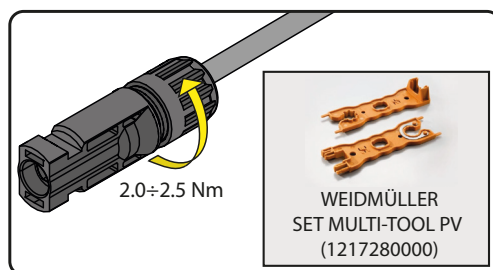

### 3. MULTICONTACT MC4 quick-fit connectors

Installation of Multicontact MC4 connectors requires crimping to be carried out with suitable equipment.

- Strip the cable to which you want to apply the connector (after verifying that it complies with the connector limits).

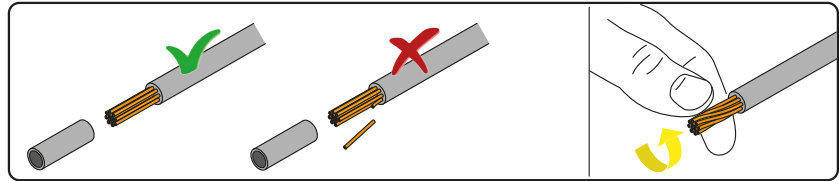
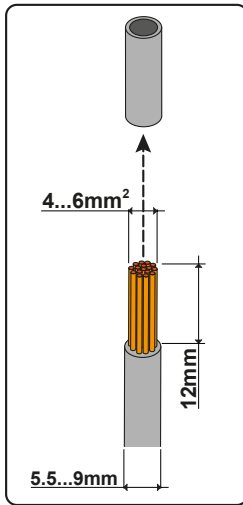

- Apply the terminal to the conductor using the designated pliers.

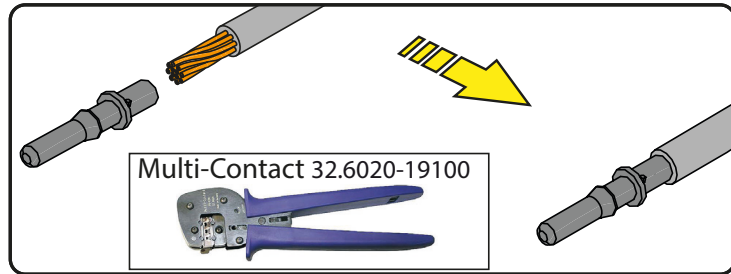

- Insert the cable with the terminal into the interior of the connector, until you hear the click indicating that the terminal is locked inside the connector.

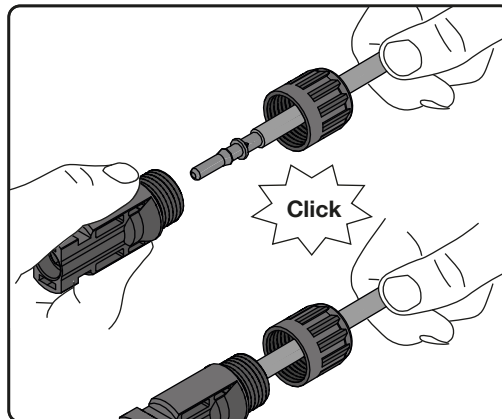

- Firmly tighten the cable gland using the relevant tool to finish the operation.

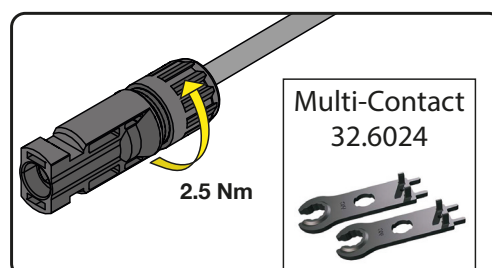

#### 4. AMPHENOL H4 quick-fit connectors

Installation of Amphenol H4 connectors requires crimping to be carried out with suitable equipment.

- Strip the cable to which you want to apply the connector (after verifying that it complies with the connector limits).

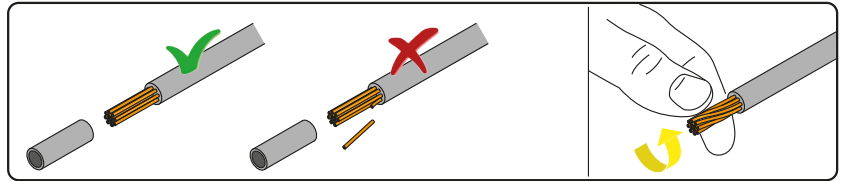
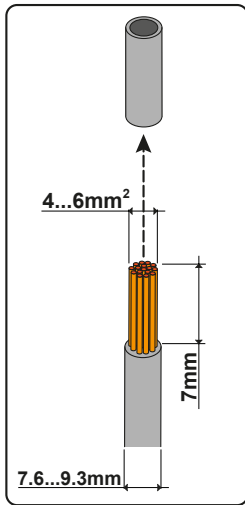

- Apply the terminal to the conductor using the designated pliers.

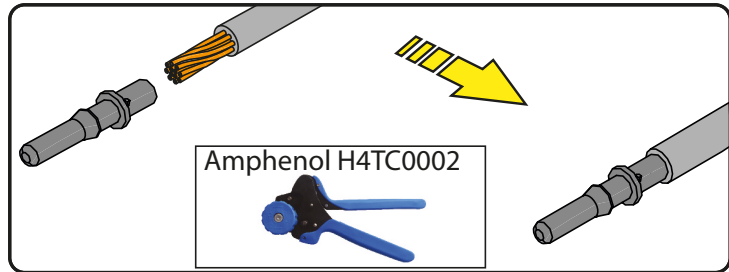

- Insert the cable with the terminal into the interior of the connector, until you hear the click indicating that the terminal is locked inside the connector.

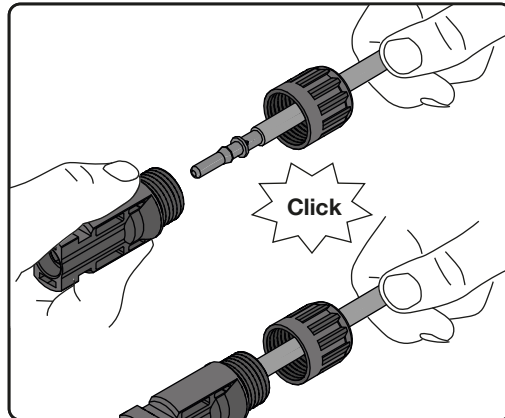

- Firmly tighten the cable gland using the relevant tool to finish the operation.

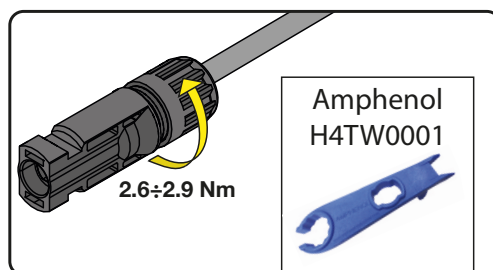

## Communication and control signal connections

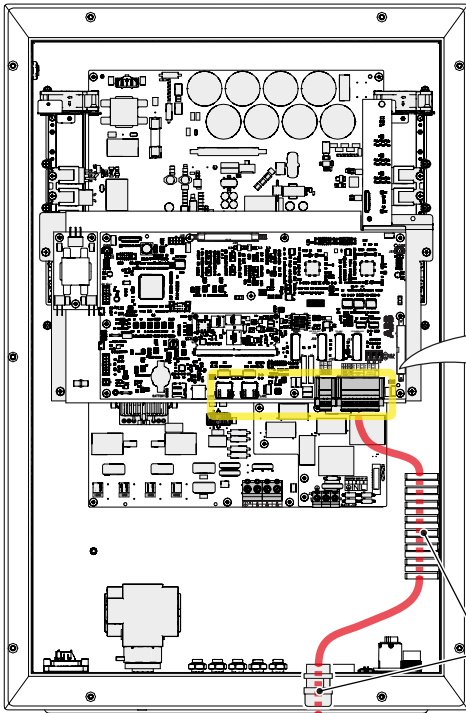

A communication and control service cable that must be connected inside the REACT2-UNO must pass through:

- the service cable gland **13**.
- the cable conduit **44**.

The M25 service cable gland **13** can take a cable with a diameter of 10 mm to 17 mm (tightening torque 7.0Nm).

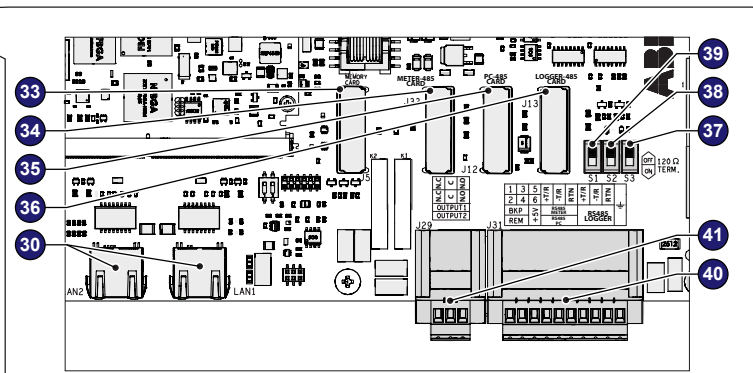

Terminal name	Terminal number	Description of communication and control signal screw terminal block <b>40</b>
BKP	1, 3	External backup command
REM	2, 4	Remote external ON/OFF command
+5V	5, 6	Auxiliary 5V positive
RS485 METER	7	+T/R RS485 METER (connected on the external meter connector <b>14</b> )
	9	-T/R RS485 METER (connected on the external meter connector <b>14</b> )
	11	Reference (RTN) RS485 METER (connected on the external meter connector <b>14</b> )
RS485 PC (FIMER service use only)	8	+T/R of the RS485 PC communication line (FIMER service use only)
	10	-T/R of the RS485 PC communication line (FIMER service use only)
	12	Reference (RTN) of the RS485 PC communication line (FIMER service use only)
RS485 LOGGER	13, 14	+T/R of the RS485 LOGGER communication line
	15, 16	-T/R of the RS485 LOGGER communication line
	17, 18	Reference (RTN) of the RS485 LOGGER communication line
⏏	19, 20	Ground terminal

Terminal name	Terminal number	Description of multifunction relay screw terminal block <b>41</b>
OUTPUT 1	N.C.	"Normally closed" terminal of multifunctional relay (OUTPUT 1)
	C	"Common" terminal of multifunctional relay (OUTPUT 1)
	N.O.	"Normally open" terminal of multifunctional relay (OUTPUT 1)
OUTPUT 2	N.C.	"Normally closed" terminal of multifunctional relay (OUTPUT 2)
	C	"Common" terminal of multifunctional relay (OUTPUT 2)
	N.O.	"Normally open" terminal of multifunctional relay (OUTPUT 2)

Terminal name	Connector Type	Description of RJ45 (LAN) connectors <b>30</b>
LAN 1	RJ45	LAN Ethernet connector
LAN 2	RJ45	LAN Ethernet connector

## External backup command connection

The REACT2 system is equipped with a BACKUP AC output that can be activated in two different ways (Auto or via external control) settable via web server user interface (see the specific paragraph on chapter 7).

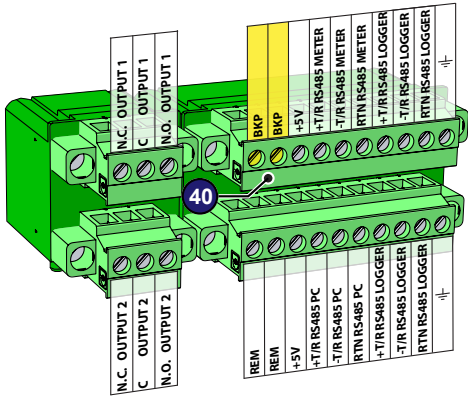

In case of external control (BKP terminals) selection, backup output is activated when terminal 1 is brought to the same potential as terminal 3 (i.e. positioning a switch to create a short circuit between the two terminals on the communication and control signal terminal block 40).

The condition of going into backup is shown on the synoptic.

Since this is a digital input, there are no requirements to be observed as regards cable cross-section (it only needs to comply with the sizing requirement for passing cables through the cable glands and the terminal block).

## Remote control connection

The connection and disconnection of the inverter to and from the grid can be controlled through an external control (see the specific paragraph on chapter 7).

The function must be enabled via web server user interface. If the remote control function is disabled, the switching on of the inverter is dictated by the presence of the normal parameters that allow the inverter to connect to the grid.

If the remote control function is on, besides being dictated by the presence of the normal parameters that allow the inverter to connect to the grid, switching on the inverter also depends on the state of REM terminals (terminal 2 and terminal 4) on the communication and control signal terminal block 40.

When terminal 2 is brought to the same potential as terminal 4 (i.e. positioning a switch to create a short circuit between the two terminals), the inverter is disconnected from the grid.

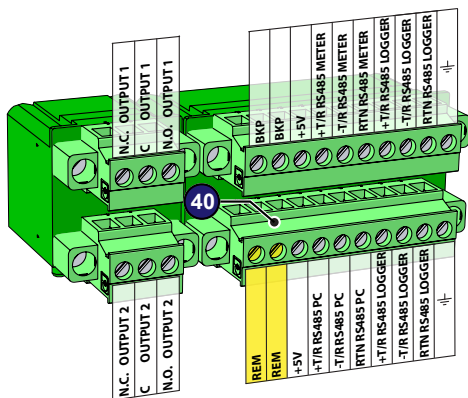

The connection and disconnection of the inverter to and from the grid can be controlled through an external control.

Since this is a digital input, there are no requirements to be observed as regards cable cross-section (it only needs to comply with the sizing requirement for passing cables through the cable glands and the terminal block).

## +5V output connection

On the communication and control signal terminal block **40** there is auxiliary voltage of +5V.

The maximum absorption permitted from this auxiliary power supply voltage is 100 mA.

## Connection of RS485 LOGGER serial communication line

The RS485 LOGGER serial communication line on the communication and control signal terminal block **40** is reserved for the connection of the inverter to monitoring devices that communicate with the Modbus communication protocol. On the communication and control signal terminal block **40** there are two connection points for each serial line signal (+T/R, -T/R and RTN) so as to be able to make a daisy-chain connection (“in-out”) of multiple inverters.

Connection of a monitoring system to the RS485 LOGGER communication line consists of first connecting all the units in the chain in the “daisy-chain” (“in-out”) configuration, respecting corresponding signals, and then activating the communication line termination resistance in the last element in the chain by setting the RS485-LOGGER line termination switch **37** (to the ON position).

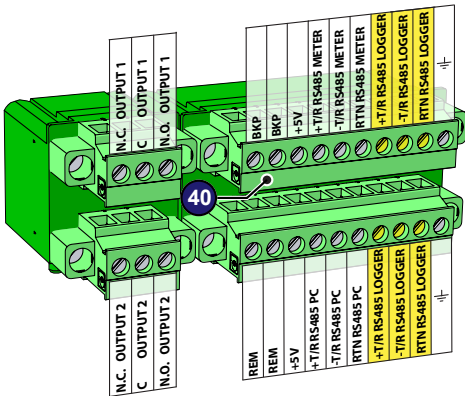

The communication line must also be terminated on the first element of the chain which usually corresponds to the monitoring device.

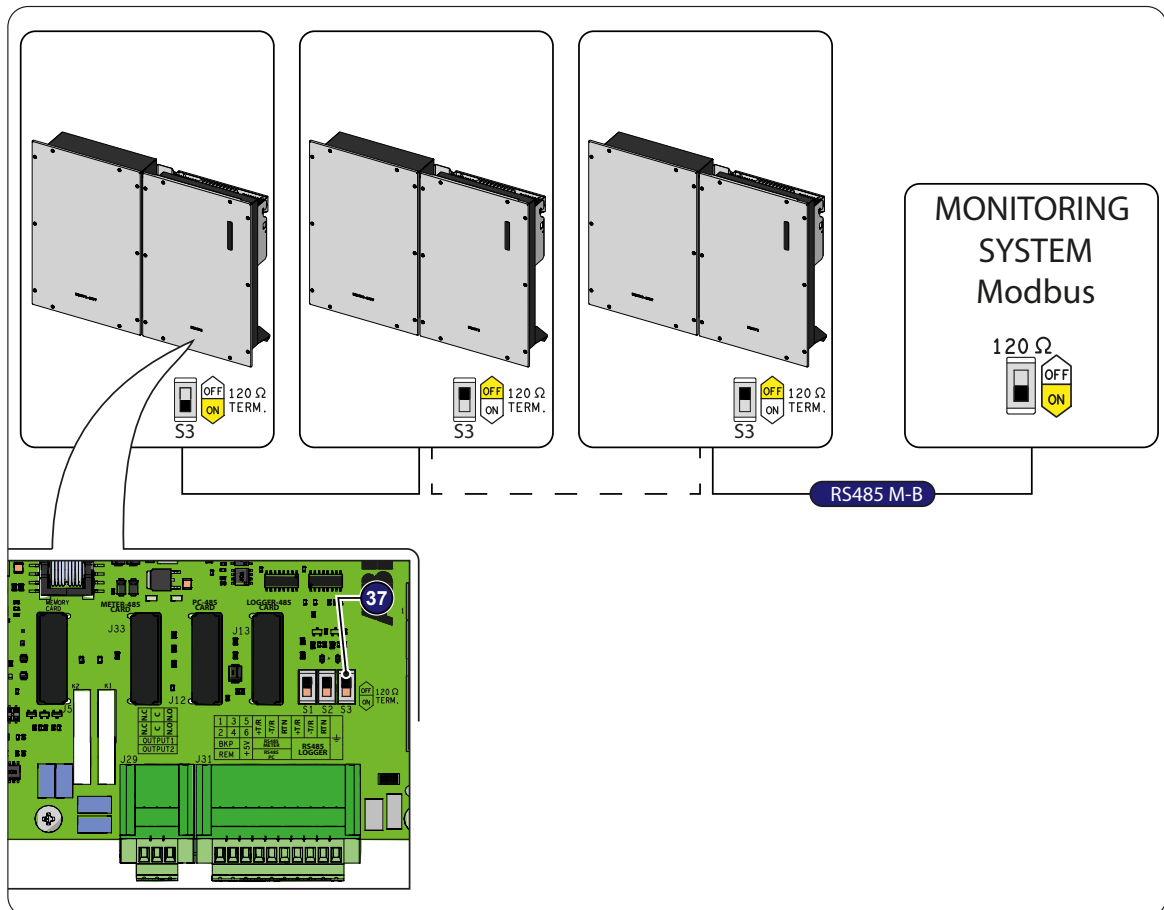

When connecting a single inverter to the monitoring system, activate the

communication line termination resistance by setting the RS485-LOGGER line termination switch 37 (to the ON position).

Set a different RS485 address on each inverter of the chain. An address can be chosen freely from out of 1 to 63.

The inverter address is set using the web server user interface (see the specific paragraph on chapter 7).

When an RS-485 connection is being used, if one or more inverters are added to the system at a later time, it is necessary to remember to reset to OFF the switch on the termination resistance being used by the inverter which previously was the last in the system.

Each inverter is supplied with one (1) preset RS485 address and with the RS485-LOGGER line termination switch 37 in the OFF position.

Connect the signals respecting the following positions:

Terminal name	Terminal number	Description
RS485 LOGGER	13, 14	+T/R of the RS485 LOGGER communication line
	15, 16	-T/R of the RS485 LOGGER communication line
	17, 18	Reference (RTN) of the RS485 LOGGER communication line



For long distance connections, it is preferable to use a shielded twisted pair cable with characteristic impedance of  $Z_0=120\text{ Ohm}$  like the one shown in the following table:

	Signal	Symbol
	Positive data	+T/R
	Negative data	-T/R
	Reference	RTN
	Shield	$\perp$

Shield continuity must be provided along the communication line and must be grounded at a single point using terminal 19 or 20 ( $\perp$ ).



## Ethernet connection

The ethernet connection allows a direct data transfer to the FIMER server for monitoring purpose.

When the inverter will be powered on, network parameters are automatically set and the inverter starts transmitting telemetry data to the Aurora Vision® CLOUD platform.

The connection of the ethernet communication cable must be made on the specific connectors **30** located on the communication and control board inside the REACT2-UNO **02**. If the inverters of the plant need to be connected in daisy chain or ring configuration use both connectors.

The cable should be compliant to the following specification:

- Cable type: Patch or Cross type, 100BaseTx, CAT5e (or higher) with shielding STP or FTP.
- UV-resistant if used outdoors
- Type of plug: metallic shielded RJ45
- The maximum length that can reach these cables is 100 meters, and it is always advisable not to let them pass by the power cords to avoid interference with data transmission.
- Maximum inverters number connected over one single daisy chain is 40



*In order to avoid ground loop (that could create communication issues) the shield of any Ethernet cable must be connected to the RJ45 plug in only one side, the other side of the shield should be leaved floating. This could be guaranteed by crimping the shield or the screen of the ethernet cable to the RJ45 connectors only at one end of each cables.*

Connection of ethernet cable is made trough the two RJ45 connectors **30**.

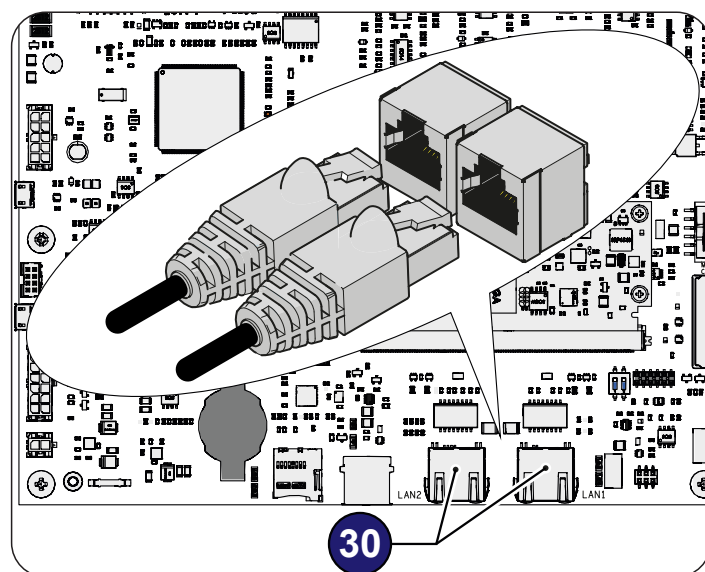

The two RJ45 connectors LAN1 and LAN2 are equivalent to each other and can be used interchangeably for the input or for the output of the line in realising the connection of the inverters.

Three topologies of ethernet connection to the router are available:

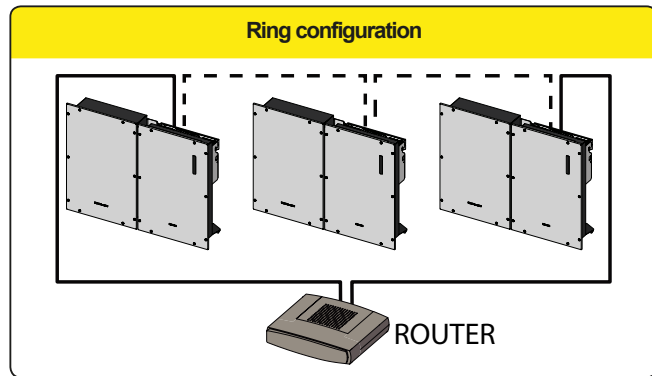

*The ring configuration is the preferable way to connect the units in order to allow reaching inverters in case of single inverter fault.  
In case inverters are connected to the networking switch with a ring topology is recommended to enable SPT protocol on the switch*

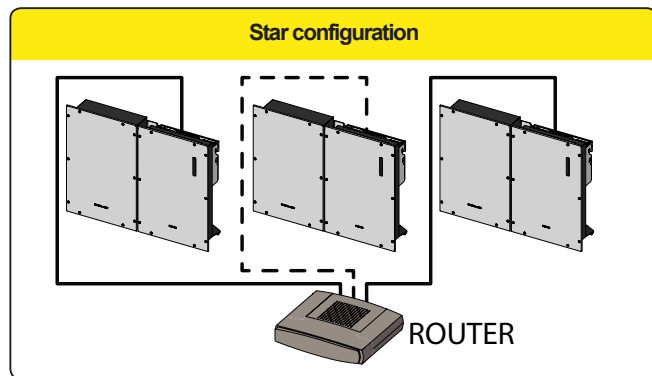
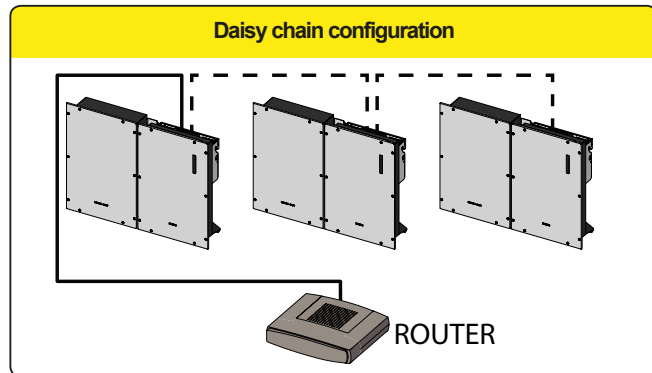

On each configuration of connection the maximum length of the cable must be 100m maximum between inverter – inverter and inverter – switch.



*For further information on the Ethernet connection refer to the Local Area Network standard IEEE802.3*

Please refer to Aurora Vision documents available on FIMER website for further information how to get an Aurora Vision account for remotely monitoring and managing the installed solar assets.



*No initial setup is required to start data transmission to Aurora Vision.  
Internet connection is required to use all the Aurora Vision remote functionalities.*

## Configurable Relay connection (OUTPUT 1 and OUTPUT 2)

The inverter is equipped with 2 multifunction relays with configurable activation. It can be connected with normally open contact (being connected between the NO terminal and the common contact C) and with normally closed contact (being connected between the NC terminal and the common contact C).

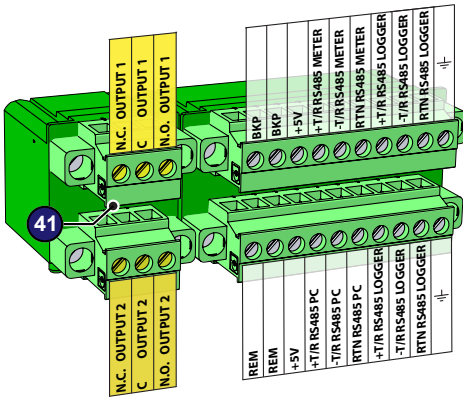

Terminal name	Terminal number	Description
OUTPUT 1	N.C.	"Normally closed" terminal of multifunctional relay
	C	"Common" terminal of multifunctional relay
	N.O.	"Normally open" terminal of multifunctional relay
OUTPUT 2	N.C.	"Normally closed" terminal of multifunctional relay
	C	"Common" terminal of multifunctional relay
	N.O.	"Normally open" terminal of multifunctional relay

Different types of devices (light, sound, etc.) can be connected to the relay, provided they comply with the following requirements:

### Alternating current

Maximum Voltage: 240 V AC

Maximum Current: 1 A

### Direct current

Maximum Voltage: 30 V DC

Maximum Current: 0.8 A

### Cable requirements

Conductor cross-section: from 0.14 to 1.5 mm<sup>2</sup>

This contact can be used in different operating configurations that can be selected by accessing the web server user interface (see the specific paragraph on chapter 7).



*The ALARM contact can be used only with systems that ensure a safety isolating additional at least (supplementary insulation in relation to the DC input voltage)*

## General conditions

One of the first rules for preventing damage to the equipment and to the operator is to have a thorough knowledge of the instruments. We, therefore, advise that you carefully read this manual. If you are not sure about any information in this manual, please ask FIMER Service for more detailed information.



*Do not use the equipment if:*

- *you do not have suitable qualifications to work on this equipment or similar products;*
- *you are unable to understand how it works;*
- *you are not sure what will happen when the buttons or switches are operated;*
- *you notice any operating anomalies;*
- *there are doubts or contradictions between your experience, the manual and/or other operators.*





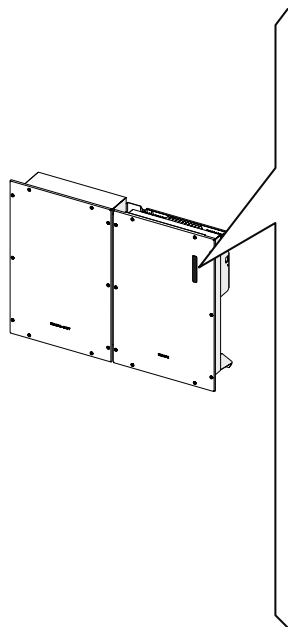

FIMER cannot be held responsible for damage to the equipment or the operator if it is the result of lack of knowledge, insufficient qualifications or lack of training.

## User interface

### Description of the synoptic

The synoptic  functions on the inverter are described below.



Synoptic icon	Description
	Indicates the status of the inverter's grid connection
	Indicates the status of the WI-FI or ETHERNET communication lines.
	Communication status with external meter
	Communication status with batteries
	Indicates that the inverter has detected an anomaly. The type of problem is highlighted in the Web User Interface .
	The "GFI" (ground fault) LED indicates that the inverter has detected a ground fault in the DC side PV generator.

*The synoptic icons, in various multiple available combinations (and color), can signal multiple conditions other than the original single condition (see the chapter 7, Synoptic icons behaviour).*

### Embedded Web User Interface

- Accessible via Wi-Fi by using any WLAN enabled standard device (PC, smartphone, tabled,....)
- Enables single inverter commissioning and parameters settings.
- Updating the inverter firmware.

### Aurora Vision Plant Management Platform

Additional to any local user interfaces the inverter comes with capability enabling remote monitoring and managing via Aurora Vision Plant Management Platform cloud. Aurora Vision offert includes:

- Plant Portfolio Manager: web portal for solar professional.
- Plant Viewer: single web page for casual user.
- Plant Viewer for Mobile: mobile application for plant monitoring.
- Kiosk view: single HTML5 page for public visualization of plant data.
- API: web based tool for enabling the sharing of the data with a third party data.

## FIMER Ability™ Energy Viewer for solar plants

Energy Viewer is a powerful and easy-to-use mobile app enabling customers to monitor the performance as well as the energy flows of their own solar plants, with and without an energy storage installed, from remote.

Energy Viewer enables users to visualize in graphs and charts all energy flows within a photovoltaic site and provides a very intuitive tool for optimizing our self-consumption and self-sufficiency.

The main features of Energy Viewer are:

- Tracking of all the energy flows within a photovoltaic installation, with and without storage system installed
- Tracking of systems parameters by graphs and charts
- Tools allowing understanding energy consumption, self-consumption and self-sufficiency.
- Fully Integration with Aurora Vision® cloud platform
- Professional tool allowing monitoring Health and Performance rate of photovoltaic and storage installations
- Notification of Events / Alarms
- Possibility to update the FW of all components installed from remote
- Compatible with iOS (version 8.x or greater) and Android (version 4.x or greater) devices

Energy Viewer is fully integrated with Aurora Vision® cloud platform and any owner of an Aurora Vision® account can use it.

Please ask for your own Aurora Vision account to the administrator of your solar plant or get a new account autonomously by clicking on REGISTER WITH PLANT VIEWER button you find on [www.auroravision.net](http://www.auroravision.net)

## Measurement tolerance

The data supplied by the inverter may differ from measurements taken by certified measuring instruments (e.g. output meters, multimeters and grid analysers); since the inverter is not a measuring instrument it has wider tolerances for the measurements it makes.

The tolerances are generally:

- ±5% for real-time measurements with output power below 20%
- ±3% for real-time measurements with output power above 20%
- ±4% for all statistical data.

## General conditions

Before checking the operation of the equipment, it is necessary to have a thorough knowledge of the Instruments chapter 6 and the functions that have been enabled in the installation process.

The equipment operates automatically without the aid of an operator; the operating state should be controlled through the equipment's instrumentation.

*The interpretation or variation of some data is reserved exclusively for specialized and qualified staff.*



*The input voltage must not exceed the maximum values shown in the technical data, section 2 in order to avoid damaging the equipment. Consult the technical data for further details.*

During operation, check that the environmental and storage conditions are correct (see installation chapter 5).

Make sure that environmental and storage conditions have not changed over time and that the equipment is not exposed to adverse weather conditions.

## Commissioning



*Do not place objects of any kind on the inverter during operation!  
Do not touch the heat sink while the inverter is operating!  
Some parts may be very hot and cause burns.*

*Before proceeding with commissioning, make sure you have carried out all the following checks:*

- Check the correct connection and polarity of the DC inputs, and the correct connection of the AC output and ground cables.



- Check the correct connection of the power and signal cables between REACT2-UNO and REACT2-BATT
- Check the sealing barrier of the cable ducts and installed quick-fit connectors to prevent accidental disconnections and/or avoid compromising the IP65 environmental protection rating.

Commissioning is carried out via Wi-Fi connection to the REACT2's internal web user interface. Initial setup of the REACT2 system must therefore be carried out via a tablet, notebook or smartphone with a Wi-Fi connection. To establish the connection and operate with the REACT2, it is necessary to power up the inverter by connecting its input to the DC voltage of the photovoltaic panels or its output to the AC grid.

- Supply the inverter with DC input voltage from the photovoltaic generator and/or via AC GRID voltage.



*Where the system is powered by the photovoltaic generator (DC) make sure irradiation is stable and adequate for the REACT2's commissioning procedure to be completed.*

- Supply grid AC voltage to the inverter

SN WLAN: SSSSSSSSS  
PN WLAN: PPP.PPPPP.PP  
MAC: XX:XX:XX:XX:XX:XX

*Remove and apply  
on the Quick  
installation guide*



SN Inverter: SSSSSSSSS  
MAC: XX:XX:XX:XX:XX:XX  
PK: KKKK-KKKK-KKKK-KKKK

- **Pre-commissioning phase 1 - Connection to the local Wi-Fi network**  
- DEVICE USED TABLET/SMARTPHONE.

Once powered, launch a QR reader for mobile and SCAN the QR code marked with  on the label on the right side of the inverter and connect to inverter network (tap connect).

The name of the Wi-Fi network created by the system, that the connection should be established with, will be:

ABB-XX-XX-XX-XX-XX-XX (where the X is the MAC address)

After this step wait 10 seconds to allow the WLAN connection

- DEVICE USED LAPTOP.

Enable the wireless on the device you are using for the commissioning and search for the network named ABB-XX-XX-XX-XX-XX-XX, where "X" is an hexadecimal number of the MAC Address (the MAC Address is indicated on the "wireless identification label" on the side of the inverter).

When prompted, type the PK (product key), including the dashes. Example: 1234-1234-1234-1234 as the network password.





• **Pre-commissioning phase 2 - Internal web UI access**

- DEVICE USED TABLET/SMARTPHONE.

SCAN this QR code (it is also reported in the “Inverter Pre-Commissioning” flyer inside the box of the REACT2-UNO). An internet browser page showing the step by step procedure will be open.



The information contained in this QR code is the IP address of the web user interface of the inverter: <http://192.168.117.1>

Recommended browsers: Chrome from v.55, Firefox from v.50, Safari from V.10.2.1

- DEVICE USED LAPTOP.

Open an internet browser page and insert <http://192.168.117.1> on the address bar.

**STEP 1 - Administrator/User login credentials**

**Administrator account**

Create Administrator Account

Password

Confirm Password ●

Passwords match

**User account**

Create User Account

No user password

Password

Confirm Password ●

Passwords match

- Set the Administrator account user and password (minimum 8 character for password):  
Administrator account can open and view the contents of photovoltaic site. Additionally, they can make changes to inverter settings. User and password are CASE SENSITIVE.

- Set the User account user and (optional) password (minimum 8 character for password):  
User account can only read data. It cannot make any changes. User and password are CASE SENSITIVE.

- Click on “Next” button to proceed to the next stage of the configuration wizard.

**STEP 2 (Optional) - Residential wireless network connection.**

The parameters relating to the home wireless network (set on the router) that must be known and set during this step are:

IP Settings: DHCP or Static.

If you select the DHCP function (default setup) the router will automatically assign a dynamic IP address to the inverter whenever it tries to connect to the user network. With Static, the user can assign a fixed IP address to the system. The data which has to be entered in order for IP static address assigning to take place will appear. Complete the additional fields at the bottom of the screen (all the fields are mandatory with the exception of the secondary DNS server).

Available networks (SSID): Identify and select your own (home) wireless network from all those shown in the SSID field (you can carry out a new search of the networks that can be detected with the Update button ). Once the network has been selected, confirm.

Password: Wireless network password.

Enter the password for the destination network (if necessary) and start the connection attempt (it will take a few seconds).

Click on “Connect” button to connect the inverter to the home wireless network.

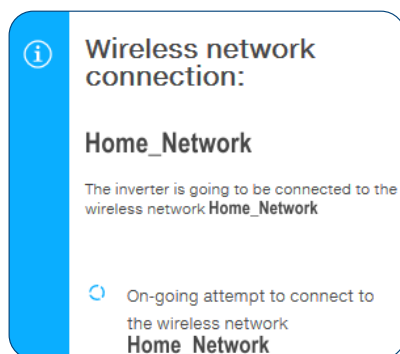

A message will ask for confirmation. Click “Next” to connect the inverter to the home wireless network.

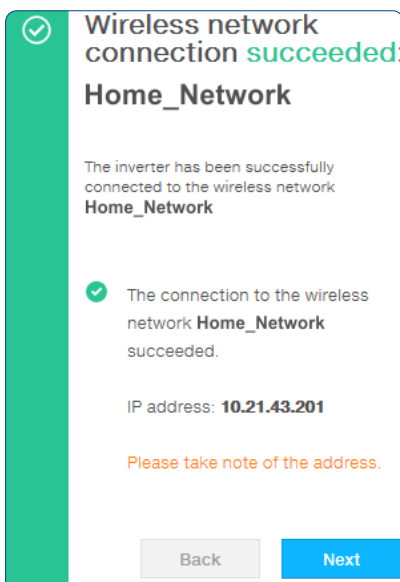

Once the inverter is connected to the domestic wireless network, a new message will confirm that. The message provides the IP Address assigned by the home wireless network router to the inverter that can be used each time you want to access the internal webserver, with the inverter connected to the home wireless network. Take note of it.

Click on “Next” button to proceed to the next stage of the configuration wizard.



The IP address assigned may vary for reasons connected to the wireless home router setup (for example, a very brief DHCP lease time). If verification of the address is required, it is usually possible to obtain the client list (and the corresponding IP addresses) from the wireless router administration panel.

If the inverter loses the connection with the home wireless network, it is available accessing the Wi-Fi network ABB-XX-XX-XX-XX-XX-XX, where “X” is a hexadecimal number of the MAC Address.



The most common causes of losing connectivity might be: different wireless network password, faulty or unreachable router, replacement of router (different SSID) without the necessary setting updates.

### .STEP 3 - Date, Time and Time zone

#### Date and Time

✔ A NTP server has been detected and it will be used to keep the system clock synchronized.

Date ●

Aug 30, 2018

SET by the NTP server

Time ●

11:35 AM

SET by the NTP server

Time Zone

Europe/Berlin GMT+01:00

Next

Set the Date, Time and Time zone (The inverter will propose these fields when available). When it's not possible for the inverter to detect the time protocol, these fields have to be manually entered.

Click on “Next” button to proceed to the next stage of the configuration wizard.

## STEP 4 - Type of coupling, Inverter country standard, Input mode, Meter and Energy policy, Battery and Backup mode configuration

DC Coupled     AC Coupled

### Country standard

Select The Country Standard (Grid Code)

-- Please select --

Required

### Input mode

PV Input Channels Configuration

Independent

### Meter

Meter Model

REACT-MTR-1PH

### System configuration

- DC coupled (new installations). Select this mode if the inverter is connected to the AC network and to the photovoltaic generator.
- AC coupled (retrofit with existing solar inverters). Select this mode if the inverter is connected only to the AC network and in combination with a standard inverter connected to the photovoltaic generator.

### Country standard

Set the grid standard of the country in which the inverter is installed.



*From the moment that the grid standard is set, you have 24 hours to make any changes to the value, after which the “Country Select > Set Std.” functionality is blocked, and the remaining time will have to be reset in order to have the 24 hours of operation available again in which to select a new grid standard (follow the procedure “Resetting the remaining time for grid standard variation” described in the relevant section).*

**Input mode** (not available if “AC coupled” system configuration was selected)

- Independent
- Parallel

See the relevant section of this manual to know how to physically set the input mode

### Meter

When a meter device is connected to the inverter, it's requested to select the meter model:

- None (where system is installed without meter)
- REACT-MTR-1PH (single-phase)
- FIMER 3PH (three-phase)
- FIMER 1PH (single-phase)



*If a 3PH energy meter (FIMER B23, B24) is used in the system as single-phase inverter, it will be necessary to select FIMER 3PH and the phase to which the inverter is connected.*

**Battery**

- Battery Type. Select REACT2-BATT.
- Number. Set the number of REACT2-BATT (battery unit) installed.

**Energy Policy**

- Energy Policy: set the way to manage the energy produced by the PV plant, choosing from the following:

**Battery**

Battery Type

None
▼

**Energy policy**

Energy Policy

-- Please select --
▼

Required

Backup Mode

None
▼

i The inverter will be rebooted after the country standard change. The procedure may take several minutes.

BACK

DONE

Management mode	Description
Zero injection	The system automatically manages power flows in order to avoid the injection of energy to the grid. If the meter is disconnected or not working the inverter's output power is restricted to zero in order to avoid accidental power feeding to the grid.
Self consumption	The system automatically manages power flows in order to maximise self-consumption. All unused power from domestic loads will feed into the grid.
Backup only	Visible only if "AUTO" or "External Control" option is selected in the "Backup Mode" section) The battery has priority over the loads, so it is kept charged until the backup output is activated.
Custom	The system automatically manages power flows in order to avoid feeding the grid with power greater than: $PDC \times Plim$ where PDC is the power of the photovoltaic generator ("PV GENERATOR POWER" parameter) and Plim is the output power limit with respect to PDC(%) ("FEED-IN POWER" parameter). - PV Generator Power (Wp): Insert the power value of the photovoltaic system installed. - Feed-in Power (% PV Generator Power): Set the percentage AC power restriction (with reference to the value of the photovoltaic system (kWp) installed) to be feed into the grid.

- Backup Mode:  
Set the way to manage the backup functionality, choosing from: AUTO. The necessary condition for activating the backup function is the lack of grid.  
External Control. The backup function is controlled by an external command.

 **Commissioning Tests**

-  Meter
-  Battery

Commissioning tests successfully executed

Confirm the settings by clicking “DONE” and the inverter will test the meter and the battery working and it will reboot at the finish of test phase.

 **Wizard completed**

Congratulations wizard successfully completed

A notification will confirm that the wizard is completed.

- After the wizard is completed, the system will power-on. The inverter checks the grid voltage, measures the insulation resistance of the photovoltaic field with respect to ground and performs other auto-diagnostic checks. During the preliminary checks on the parallel connection with the grid, the “Power” LED keeps flashing, the “Alarm” and “GFI” LEDs are off. If the outcome of the preliminary checks on the grid parallel is positive, the inverter connects to the grid and starts to export power to the grid. The “Power” LED remains fixed on while the “Alarm” and “GFI” LEDs are off.



*To address any problems that may occur during the initial stages of operation of the system and to ensure the inverter remains fully functional, you are advised to check for any firmware updates in the download area of the website [www.fimer.com](http://www.fimer.com) or at <https://registration.solar.fimer.com> (instructions for registering on the website and updating the firmware are given in this manual).*

## Free@Home protocol activation

Prerequisite for the integration of the REACT2 into free@home is a router and an operable “Free@home System Access Point”.

The Free@Home protocol can be activated accessing to the webserver.

- Login as Administrator to the internal webserver
- Click on the “Settings and parameters” icon  then click on “Logger”.
- In “Logger” section check the “Enable FIMER free@home” field: additional part of menu will appear.

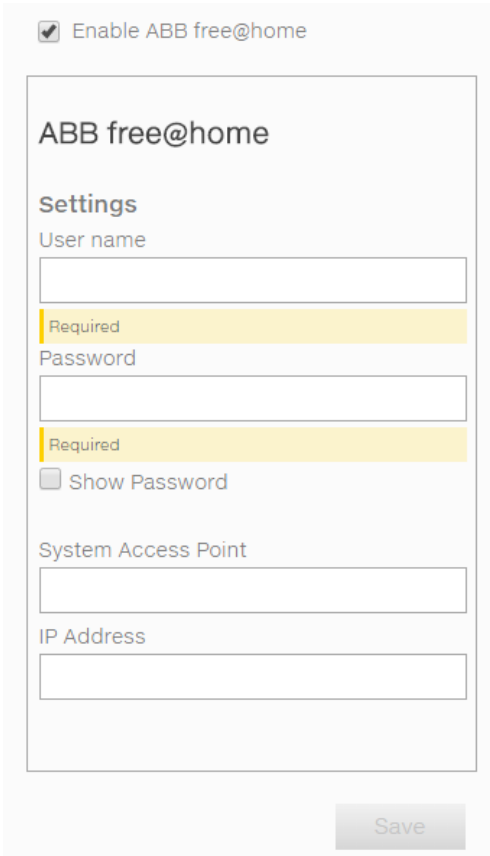

Enable ABB free@home

**ABB free@home**

**Settings**

User name

Required

Password

Required

Show Password

System Access Point

IP Address

Save

- Enter Username and password used for the “Free@Home system Access Point” then click “Save” button.

*If encounter in connection problem with FIMER-free@home System Access Point check if:*

- Both systems (REACT2 and System Access Point) has been located in the same wireless network.
- Home router supports “bonjour” service; if not it will be necessary enter the fields “System Access Point name” and “IP Address” in the previous configuration page.

## Synoptic icons behaviour

The icons of the synoptic **03** on the front panel can behave in different ways depending on the inverter's operating state.

In correspondence to each state of the inverter indicated by the constant or intermittent lighting of the specific icon, is possible to consult the status or the presence of an error/warning via web server user interface.



*In the event of malfunctioning, it is extremely dangerous to try to eliminate the fault personally. The instructions below must be followed scrupulously; if you do not have the necessary experience and training to intervene safely, please contact a specialist.*

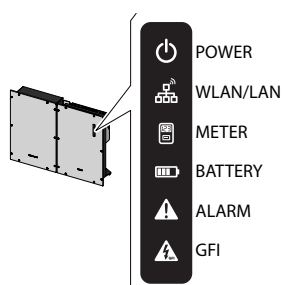

All possible icon activation combinations are shown in the following table.

In particular, each icon could behave in one of the following ways:

● = icon on

⊗ = icon flashing (slow)





















⊗ = icon flashing (fast)









○ = icon off







⊗ = Any one of the conditions described above













Icons status		Operating state
		<b>Firmware programming</b> The inverter firmware is being programmed
		<b>Night mode (inverter automatically switches off)</b> The inverter is in night time switch-off mode (input voltage less than 70% of the set start-up voltage).
		<b>Inverter initialisation</b> This is a transitional state due to the verification of the operating conditions. During this stage the inverter checks that the conditions for connecting to the grid are met.
		<b>The inverter is connected and feeds power into the grid</b> Normal operation. During this stage, the inverter automatically tracks and analyses the photovoltaic generator's maximum power point (MPP).
		<b>Disconnection from the grid</b> Indicates no grid voltage. This condition does not allow the inverter to connect to the grid (the inverter display shows the message "Missing Grid").
		<b>Indication of Warning (W message codes) or Error E warning codes)</b> Indicates that the inverter control system has detected a warning (W) or error (E). The display shows a message indicating the type of problem found (see Alarm messages).
		<b>Backup operating modes</b> Depending on the different modes that can be set, and after detecting the conditions required for the output to be enabled, the system went into backup operation



Icons status	Operating state
  	
     	<b>Blackstart operating mode</b>
     	<ul style="list-style-type: none"> <li>• <b>Ventilation anomaly</b> Indicates an anomaly in the operation of the internal ventilation system that could limit output power at high ambient temperatures.</li> <li>• <b>Autotest (for Italian grid standards only)</b> The inverter is performing an Autotest</li> </ul>
     	<ul style="list-style-type: none"> <li>• <b>Anomaly in the insulation system of the photovoltaic generator</b> Indicates that a leakage to ground from the PV generator has been detected, causing the inverter to disconnect from the grid.</li> <li>• <b>Indicates an operating anomaly in the battery unit</b></li> </ul>

Icon status	Operating state
	
 	<b>Wireless not configured or/and Ethernet cable not connected.</b> The inverter is in night
 	<b>Scanning for available wireless networks.</b>
 	<b>Trying to connect to a network (wifi or ethernet)</b>
 	<b>Wireless or Ethernet network is connected to the network</b>

Icon status	Operating state
	
 	<b>"No meter" has been configured during commissioning</b>
 	<b>Meter is communicating</b>
 	<b>Meter configured and is not communicating</b>

Icon status	Operating state
	
 	<b>No battery has been commissioned</b>
 	<b>Charging</b>
 	<b>Discharging</b>
 	<b>Idle - sleep</b>
 	<b>Fault</b>
 	<b>End of battery life reached</b>

## Red GFI LED

When the icon  comes on (red), first try to reset the warning via web server user interface. Should the inverter reconnect normally to the grid, the fault was due to temporary phenomena.



*You are advised to have the plant inspected by the installer or a specialist should this malfunction occur repeatedly.*

Should the inverter not reconnect to the grid it is necessary to isolate it (DC side, AC side, and any batteries), then contact the installer or authorised centre to repair the fault to the photovoltaic generator.

## Description of the Web User Interface

The inverter is equipped with an advanced integrated Web User Interface and user interface that allow a full access to all configuration and commissioning parameters from any electronic device (laptop, tablet and smartphone).

### Access to the Web User Interface

To access to the Web User Interface is required to connect a device equipped with wireless connection (such as tablet, laptop or smartphone).

Depending on the connection method chosen during the inverter commissioning phase (“Station Mode” or “AP Mode”) it’s required to follow one of the two procedures described below:

#### Connection to the inverter in “Station Mode”

- Enable the wireless connection on the device (tablet, smartphone or laptop) and connect it to the same wireless network to which the inverter is connected.
- Open an internet browser (recommened browser: Chrome versions from v.55, Firefox versions from v.50) and enter the links (corresponding to the IP Address assigned by the router to the inverter, or the “Host Name”) provided during the commissioning phase to access the login page.



*In order to use the “Host Name” as an alternative to the dynamic IP address, the Wi-Fi router to which the board is connected (when operating in “Station Mode”) must provide the Domain Name System (DNS) service (contact the network administrator for further information regarding the presence or absence of the DNS service in the Wi-Fi router or how to enable it). In this way, even if the IP address assigned to the inverter should change over time, (dynamic IP), it will always be possible to use the same “Host Name” which will remain unchanged over time.*



*The IP address assigned may vary for reasons connected to the wireless home router setup (for example, a very brief DHCP lease time). If verification of the address is required, it is usually possible to obtain the client list (and the corresponding IP addresses) from the wireless router administration panel.*



*If the “Host Name” was lost, it could be obtained writing this url:*

**<http://ABB-XX-XX-XX-XX-XX-XX.local>**

*replacing the “X” with the hex digits of the MAC address of the inverter (it can be found on the “Communication Identification label” placed on the side of the inverter or applied during the commissioning phase to the plant documentation).*

## Connection to the inverter in “AP Mode”

- Enable the wireless connection on the device which is being used for the board setup (tablet, smartphone or PC) and connect it to the Access Point created by the inverter system: the name of the wireless network created by the system that the connection should be established with, will be:

### **ABB-XX-XX-XX-XX-XX-XX**

where “X” is a hex digit of the MAC address (MAC address can be found on the “Communication Identification label” placed on the side of the inverter or applied during the commissioning phase to the plant documentation).

- When required digit the **PRODUCT KEY** (printed on the “Communication Identification label” and applied during the commissioning phase to the plant documentation) as access point password.

**Note that it’s required to digit also the dash “-” characters of the Product Key in the password field.**



*In case of need, product key can be recovered by Aurora Vision Cloud or by calling FIMER technical support.*

- Open an internet browser (reccomended browser: Chrome versions from v.55, Firefox versions from v.50) and enter the pre-set IP address **192.168.117.1** to access the login page.

## Login page

After you have connected the device to the inverter and you access to the login page, login with the username and password created during the commissioning phase.



*User and password are CASE SENSITIVE.*



*If the Password is lost click on “Forgot your password?” to obtain the access to the Web User Interface (and it will be possible to change the password) by entering the PRODUCT KEY (printed on the “Communication Identification label” and applied during the commissioning phase to the plant documentation).*



*The language of the Web User Interface could be changed in any moment by clicking on the right status bar:*

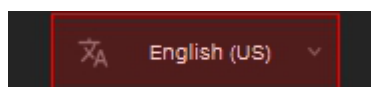

## Web User Interface menu structure



The following screenshots are related from a laptop visualization, may differ from smartphone or tablet visualization.

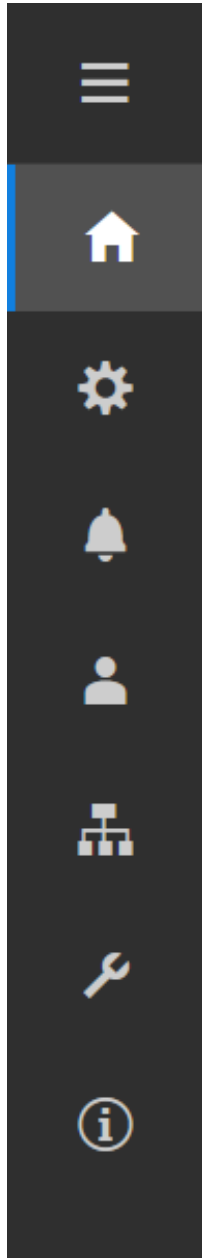

The Web User Interface is divided in six main sections, available on the left sidebar:

**MAIN:** Main section of Web User Interface dedicated to viewing the summary informations related the status and the production informations of the inverter and photovoltaic plant.

**SETTING:** Section dedicated to AC and DC line parameters configurations.

**INVERTER LOG:** Section dedicated to viewing Alarms and Warnings event log.

**USER:** Section dedicated to User management.

**CONNECTIVITY:** Section dedicated to inverter communication settings and configurations.

**SERVICE TOOLS:** Section dedicated to main service tools configurations.

**INFORMATION:** Section dedicated for general informations about the embedded Web User Interface.



## MAIN section

In the **MAIN** section it's possible to access the following sub-menus:

- **Dashboard**
- **Status Summary**
- **Meter Summary**
- **Batteries Summary**

### Dashboard

In the **Dashboard** sub-menu you can view the main informations related the status and the production informations of the inverter and photovoltaic plant and alarm/warning active events.

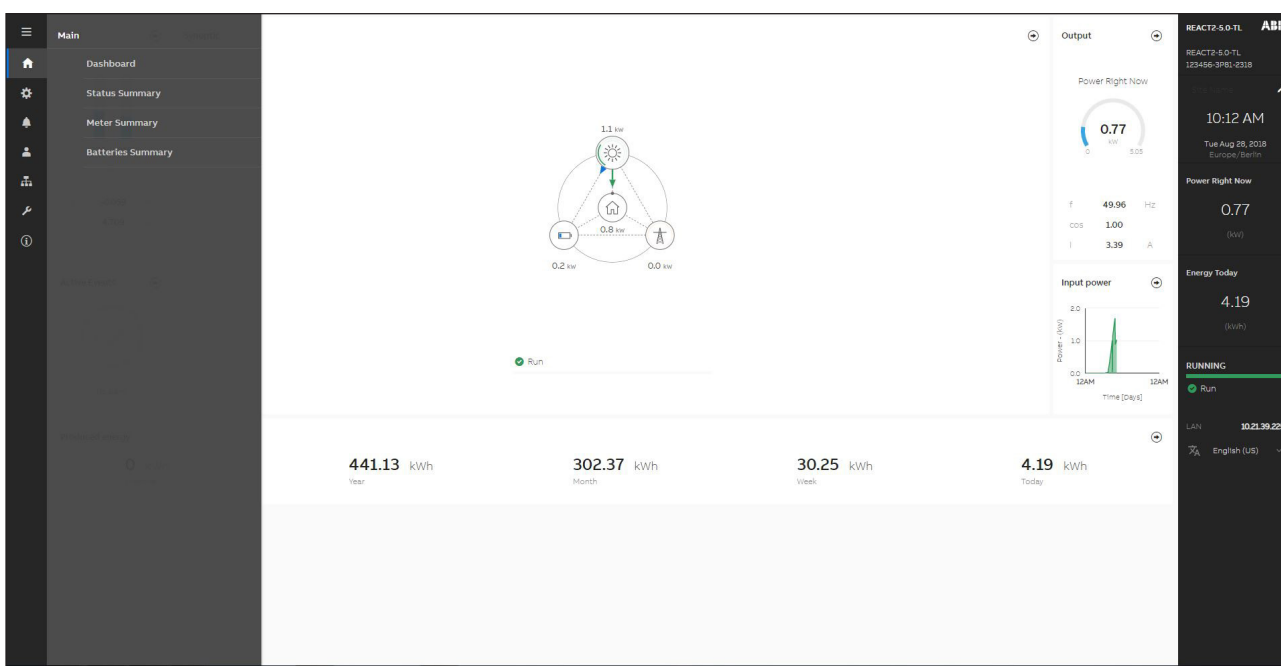

### Status Summary

In the **Status Summary** sub-menu you can view the detailed informations related the status and the production informations of the system.

### Meter Summary

In the **Meter Summary** sub-menu you can view the detailed informations related to the energy production of the system

### Batteries Summary

In the **Batteries Summary** sub-menu you can view the detailed informations related to the battery units status of the system

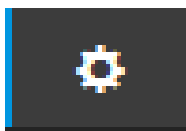

## SETTING section

In the **SETTING** section it's possible to access the following sub-menus:

- **Meter, Battery, Energy**
- **Inverter Parameters**
- **Digital Outputs**

### Meter, Battery, Energy

In the **Meter, Battery, Energy** sub-menu you can view the detailed informations related to the input mode, meter model, battery type and energy policy of the system.

### Inverter Parameters

In the **Inverter Parameters** section it's possible to access the following sub-menus:

- **AC output Rating** (*Only visible with Admin Plus privileges*)
- **AC Settings** (*Only visible with Admin Plus privileges*)
- **Active Power Control** (*Only visible with Admin Plus privileges*)
- **DC Settings**
- **Digital Inputs**
- **Frequency Control: P(f)** (*Only visible with Admin Plus privileges*)
- **Ramp Control** (*Only visible with Admin Plus privileges*)
- **Reactive Power Control** (*Only visible with Admin Plus privileges*)

### • AC output Rating (Only visible with Admin Plus privileges)

In the **AC output Rating** sub-menu you can config the output power limitation by changing the Maximum AC output power and the maximum apparent output power parameters.



*Do not change these parameters if not requested by the grid operator.*

### • AC Settings (Only visible with Admin Plus privileges)

In the **AC Settings** sub-menu you can setup the parameter related to the Output AC side:



*Changing the above-mentioned parameters may prevent disconnection from the grid if the new values exceed those given in the standards of the country of installation. If these parameters are changed to values outside the standard range, an interface protection must be installed external to the inverter in accordance with the requirements of the country of installation.*

### **Grid Connection**

By editing these settings it's possible to change the grid connection thresholds parameters to which the inverter have to connect to the grid

### **Grid Protections - VRT/FRT**

By editing these settings it's possible to enable/disable and change the grid protection intervention thresholds parameters. In addition it is possible to change voltage ride thorough (HVRT, LVRT) and frequency ride thorough (HFRT, LFRT) settings.

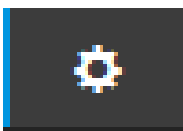

### • **Active Power Control (Only visible with Admin Plus privileges)**

In the **Active Power Control** sub-menu you can config settings related to the active power derating parameters using the following parameters groups:

1. **Active Power Curtailment**
2. **CEI Average VGrid Derating**
3. **Volt/Watt settings: P(V)**



*Do not change these parameters if not requested by the grid operator.*

### • **DC Settings**

In the **DC Settings** sub-menu you can setup the parameter related to the Input DC side:

#### **VStart 1 New Value**

This parameter is used to sets the Vstart activation voltage for the input channel 1. This voltage imposes a minimum input voltage on the inverter above which connection to the grid will be attempted.

#### **VStart 2 New Value**

This parameter is used to sets the Vstart activation voltage for the input channel 2. This voltage imposes a minimum input voltage on the inverter above which connection to the grid will be attempted.



*Change the activation voltage only if really necessary and to set it to the correct value: the photovoltaic generator sizing tool available on the FIMER website will indicate whether Vstart needs to be changed and what value have to be set.*

#### **Input Mode - Independ / Parallel**

This settings allows you to sets the input configuration mode.

#### **UV Protection Time - Value**

This section of the menu allows you to sets the time for which the inverter stays connected to the grid after the input voltage has dropped below the Under Voltage limit (set at 70% of Vstart).

(60 seconds is the default setting).

#### **Multiple Max Scan Enable**

This settings allows you to Enables/disables the scan for identifying the maximum power point of the system.

#### **Multiple Max Scan Period - Value**

This settings allows you to sets the time between scans. Remember that the shorter the scan interval the greater the loss of production, due to the fact that energy is transferred to the grid during the scan but not at the maximum power point. Each scan takes roughly 2 seconds.

### • **Digital Inputs**

In the **Digital Inputs** sub-menu you can disable or enable the Remote ON/OFF functionality related to the “Remote” terminal block [37](#).





### • Frequency Control: P(f) (Only with Admin Plus privileges)

In the **Frequency Control: P(f)** sub-menu you can config settings related to the active power derating as function of grid frequency.



*Do not change these parameters if not requested by the grid operator.*

### • Ramp Control (Only visible with Admin Plus privileges)

In the **Ramp Control** sub-menu you can config the parameter related to the active power ramp up at the start-up and after a grid fault event.



*Do not change these parameters if not requested by the grid operator.*

### • Reactive Power Control (Only with Admin Plus privileges)

In the **Reactive Power Control** sub-menu you can configure settings related the reactive power parameters using the following parameters groups:

- Watt/Cosphi Settings: Cosphi(P)
- Q Set
- Cosphi Set
- Volt/VAr Settings: Q(V)



*Do not change these parameters if not requested by the grid operator.*

## Digital Outputs

This section of the menu allows you to set the activation status of a relay and to configure customised alarm conditions.

This contact can be used, for example, to: activate a siren or a visual alarm, control the disconnect device of an external transformer, or control an external device.

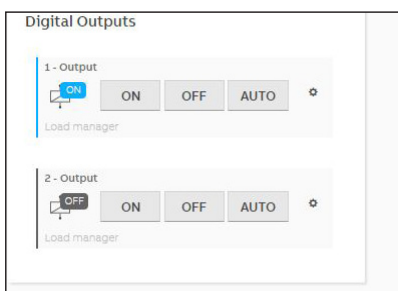

- Press  to set the operating mode of the relay. The operating modes are:

Load Manager

Alarm-Contact (Production)

Alarm-Contact (alarm ALL - no-latch)

Alarm-Contact (alarm configurable - no-latch)

Alarm-Contact (crepuscolar)

Alarm-Contact (alarm ALL - latch)

Alarm-Contact (alarm configurable - latch)

- Click on "AUTO" to activate the relay according to the set operating mode. Alternatively, the relay can be activated or deactivated manually using the "ON" and "OFF" buttons

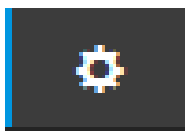

The operating modes are following described:

• **Load Manager:**

A load manager has the main objective of increasing direct self-consumption from renewable sources. The operating modes of the digital outputs vary according to the configuration of the system and therefore to the presence of the meter and / or battery. The options available are

**Modalità di funzionamento**

	No Meter	Meter	Meter+Battery
Solar production	√	-	-
Self-consumption boost	-	√	√
Self-consumption boost preserving battery	-	-	√
Low priority load disconnection	-	√	√



See the “*REACT2-Load manager*” document on the *FIMER* site for more information about operating modes.

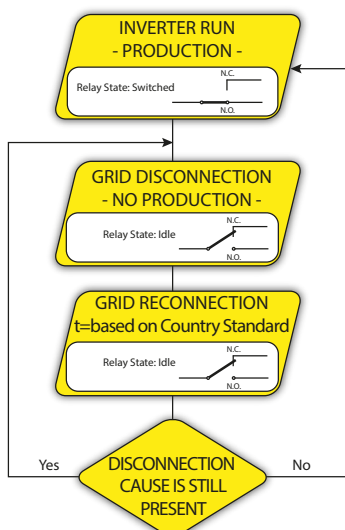

• **Alarm-Contact (Production):**

The relay is activated (status: switched) whenever the inverter connects to the grid; as soon as the inverter is disconnected from the grid (for whatever reason that caused disconnection), the relay is in its resting position.

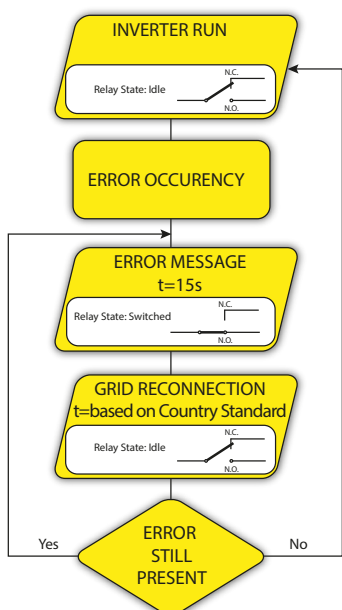

• **Alarm-Contact (alarm ALL - no-latch):**

The relay is activated (status: switched) whenever an error (code Exxx) or warnings related to grid parameters out of range (Warning – codes W003, W004, W005, W006, W007) are present on the inverter. The alarm returns to its resting position when the alarm signal ends, i.e. before the inverter checks the grid parameters after the alarm state. This is because grid control state is not an alarm state but a state of normal operation.

**Selectable alarms for which the relay is activated**

E001	E002	E003	E004	E005	E006
E007	E010	E011	E013	E014	E015
E017	E018	E019	E020	E021	E022
E023	E025	E029	E031	E032	E033
E034	E036	E037	E053	E055	E075
E077	E078	E079	E080	E084	W002
W004	W005	W006	W007	W011	W015
W017	W046	W047	W048		



In the presence of W003, W004, W005, W006, W007 signalling, the alarm contact switches to then reset itself at the end of the alarm signal. This means that during the absence of grid voltage (display message “Missing Grid”) the alarm contact remains in its resting position.

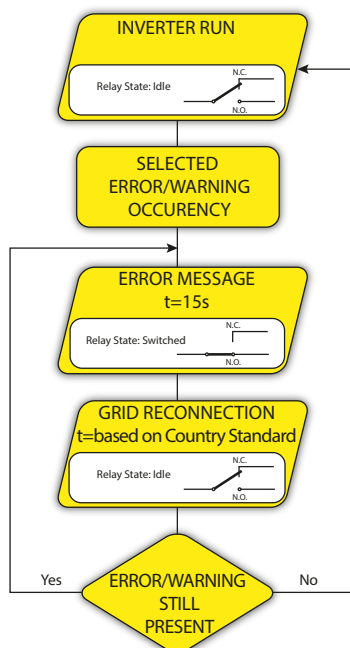
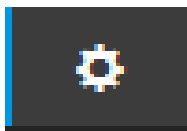

**• Alarm-Contact (alarm configurable - no-latch)**

The relay is activated (status: switched) whenever an error (code Exxx) or a warning (code Wxxx) is present from those selected from the list in the dedicated submenu **Output Activation Filter** of the inverter display. The contact returns to its resting position when the alarm signal ends, i.e. before the inverter checks the grid after the alarm state. This is because grid control state is not an alarm state but a state of normal operation.

**Selectable alarms for which the relay is activated**

E001	E002	E003	E004	E005	E006
E007	E010	E011	E013	E014	E015
E017	E018	E019	E020	E021	E022
E023	E025	E029	E031	E032	E033
E034	E036	E037	E053	E055	E075
E077	E078	E079	E080	E084	W002
W004	W005	W006	W007	W011	W015
W017	W046	W047	W048		

For the configurable relay operating mode “Alarm Conf.”, the following considerations are valid:

If the alarm condition is persistent, the alarm contact cyclically switches from its resting state to its activated state.



In the presence of W002 signalling (Input UV – input voltage below the limit of operation), the alarm contact switches to then reset itself at the end of the alarm signal. This means that during the reduced input voltage (display message “Waiting Sun”) the alarm contact remains in its resting position.

In the presence of W003, W004, W005, W006, W007 signalling, the alarm contact switches to then reset itself at the end of the alarm signal. This means that during the absence of grid voltage (display message “Missing Grid”) the alarm contact remains in its resting position.

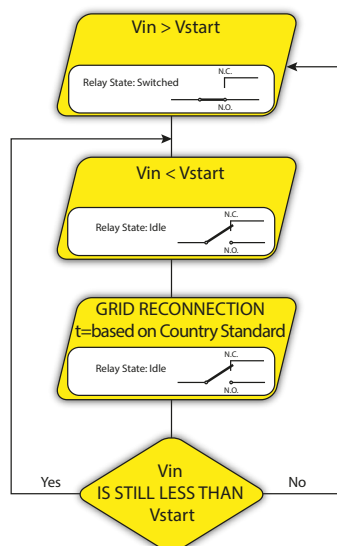

**• Alarm-Contact (crepuscular):**

The relay is activated (status: switched) as soon as the inverter input voltage exceeds the activation voltage set.

The relay switch to rest position when the input voltage drops below 70% of the activation voltage set.

This mode is useful for disconnecting any output transformers that could have unnecessary consumption during the night.

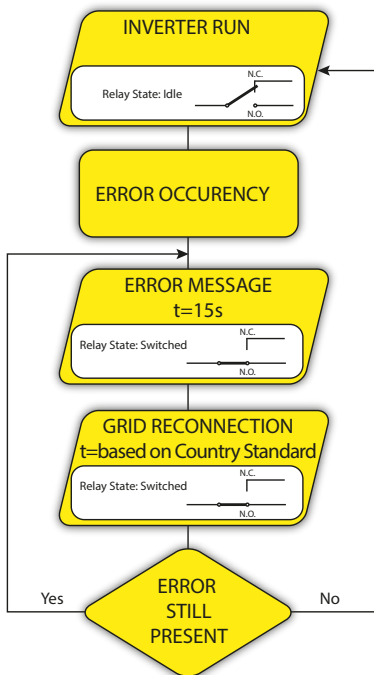
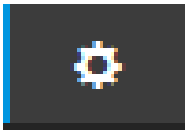

**• Alarm-Contact (alarm ALL - latch):**

The relay is activated (status: switched) whenever an error (code Exxx) or a warning (code Wxxx) is present. When the inverter returns to the normal operating state and reconnects with the grid, the contact returns to its position of rest.

**Selectable alarms for which the relay is activated**

E001	E002	E003	E004	E005	E006
E007	E010	E011	E013	E014	E015
E017	E018	E019	E020	E021	E022
E023	E025	E029	E031	E032	E033
E034	E036	E037	E053	E055	E075
E077	E078	E079	E080	E084	W002
W004	W005	W006	W007	W011	W015
W017	W046	W047	W048		

*If the alarm condition is persistent, the relay will remain activated (status:switched)*

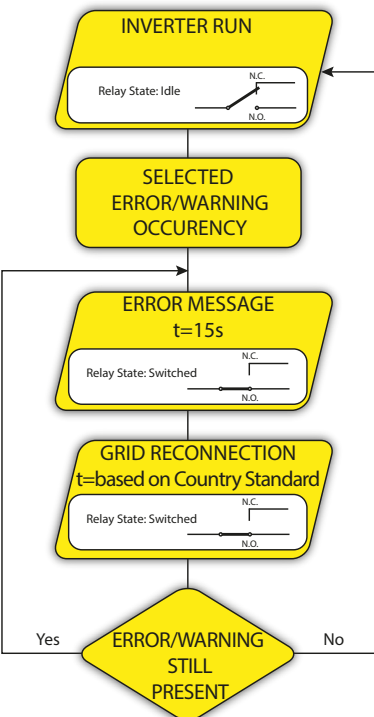

**• Alarm-Contact (alarm configurable - latch):**

The relay is activated (status: switched) whenever an error (code Exxx) or a warning (code Wxxx) is present from those selected from the list in the dedicated submenu **Output Activation Filter** of the inverter display (see the table below). When the inverter returns to the normal operating state and reconnects with the grid.

**Selectable alarms for which the relay is activated**

E001	E002	E003	E004	E005	E006
E007	E010	E011	E013	E014	E015
E017	E018	E019	E020	E021	E022
E023	E025	E029	E031	E032	E033
E034	E036	E037	E053	E055	E075
E077	E078	E079	E080	E084	W002
W004	W005	W006	W007	W011	W015
W017	W046	W047	W048		

*If the alarm condition is persistent, the relay will remain activated (status:switched)*

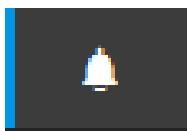

## Inverter Log

In the **Inverter Log** Section it's possible to view the Alarm and Warning events list that it can be custom filtered by type or by entering a matching word.

Clicking on any event to view his details.

The screenshot displays the 'Inverter Log' interface. At the top, there is a search bar labeled 'Filter' and a date range from 2018-07-29 to 2018-08-28. Below the date range are buttons for 'CLEAR FILTERS' and 'REFRESH EVENTS'. A horizontal menu shows 'ALL', 'EVENTS', 'UPDATES', and 'CHANGES', with 'EVENTS' selected. A pagination bar indicates '1 of 63' events. The main content area lists several events:

ID	Device	Time	Event Description	Source
123456-3P81-2318	- booster	Aug 28, 2018 9:38:23 AM	3 A → 280	Source internal by admin
123456-3P81-2318	- booster	Aug 28, 2018 9:38:23 AM	Vstart 1 New Value → 400 V	Source --- by admin
123456-3P81-2318	- batteryCharger	Aug 28, 2018 8:43:42 AM	165 error UNKNOWN EVENT	
123456-3P81-2318	- supervisor	Aug 28, 2018 6:47:00 AM	W046 warning GRID CONNECTION FAULT	
123456-3P81-2318	- supervisor	Aug 28, 2018 6:45:51 AM	W046 warning GRID CONNECTION FAULT	
123456-3P81-2318	- supervisor	Aug 28, 2018 6:44:57 AM	W046 warning GRID CONNECTION FAULT	
123456-3P81-2318	- supervisor	Aug 28, 2018 6:44:02 AM	W046 warning GRID CONNECTION FAULT	

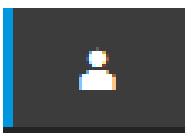

## USER section

In the **USER** section it's possible to logout from Web User Interface and return to the login page, or to access the following sub-menus:

- **Logout**
- **Edit Email and Password**
- **Admin Plus**
- **User Management**

### Edit Email and Password

In the **Edit Email and Password** sub-menu you can change the e-mail and password related to the user which is used to login to the Web User Interface:

### Admin Plus

By accessing to the **Admin Plus** sub-menu you can obtain the “Admin Plus” user privileges which allow you to:

- Change the grid standard of the inverter, after 24 hours while the inverter is operating ( so the **Country Standard** sub-menu on **TOOLS** section is locked).
- View and edit the **AC Settings, Reactive Power Control, Ramp Control, Active Power Control** and **Frequency Control: P(f)**
- View and edit the “**MPPT Noise amplitude**” field in **DC Settings** on **SETUP** section.

To access on the Web User Interface with the “Admin Plus” user privileges it's required to enter a security token that can be obtained by registering on the website <https://registration.solar.fimer.com>. Refer to the dedicated section on this topic in the manual.

### User Management

By accessing to the **User Management** sub-menu it's possible to edit all the users already created and create new users (both with admin or User privileges).



## Connectivity

In the **Connectivity** section it's possible to access the following sub-menus:

- **RS485**
- **LAN**
- **WLAN**
- **Modbus**
- **Debug Settings**

### RS485

In the **RS485** sub-menu it's possible to adjust the settings relating to the RS485 communication serial line:

- **RS485 Node Address:** It allows you to sets the address for serial communication of the individual inverters connected to the RS485 line (The addresses that can be assigned are 2 to 63).
- **RS485 Baud Rate:** It allows you to sets the Baud Rate (2400/4800/9600/19200/34800/57600/115200).
- **RS485 Parity Mode:** It allows you to set the Parity bit (No Parity, Even Parity, Odd Parity).
- **RS485 Protocol Type:** It allows you to sets the type of protocol to be used for the RS485 line.
  - "Modbus FIMER Server": General purpose communication protocol to be selected to enable monitoring and control using FIMER map.
  - "Modbus Sunspec Server": General purpose communication protocol to be selected to enable monitoring and control using Sunspec standard.
  - "Device Acquisition": Communication protocol to be used in case of connection in "Master" mode to external devices (like VSN800 weather station).

### LAN

In the LAN sub-menu it's possible to view the status and change the daisy chain configuration of the two ethernet ports of the inverter.

**LAN Status**

Daisy Chain

Linked interfaces:	<b>ETH0, ETH1</b>
IP Address:	10.21.39.225
Subnet Mask:	255.255.252.0
Gateway:	10.21.36.1
Primary DNS:	10.39.1.13
Secondary DNS:	10.39.1.14

Daisy chain configuration:

IP Settings

DHCP

#### - Daisy chain configuration: DHCP or Static:

By selecting the DHCP function (default setup) the router will automatically assign a dynamic IP address to the inverter whenever it tries to connect to the user network.

With Static, the user can assign a fixed IP address to the system. The data which has to be entered in order for IP static address assigning to take place will appear. Complete the additional fields at the bottom of the screen (all the fields are mandatory with the exception of the secondary DNS server).



## WLAN

In the **WLAN** sub-menu it's possible to view the status of the two wireless channels of the inverter, and to disconnect the channel 2.

## Modbus

In the **Modbus** submenu it is possible to set the RTU inverter communication mode (RS485):

- type the "Edit" key and select the type of external device
- According to the device, select the communication protocol of the inverter

Moreover in the TCP / IP (WLAN / LAN) section there are different settings based on the type of external device connected to the inverter.

- If the inverter acts as CLIENT and the external device as SERVER:
  - type the "Edit" key and select the type of external device
  - According to the device, select the communication protocol
  - type in the [+] key and the added device is displayed
  - change the STATE / SLAVE ID / NAME / IP ADDRESS / PORT / DEVICE settings and save them.
- If the inverter acts as a SERVER, set the port communication protocol only (Communication protocol server)

TCP/IP

[Edit WLAN](#)  
[Edit LAN](#)

Communication protocol Server Sunspec Protocol

Enabling monitoring of devices connected over Local Area Network

Used port

Add device -- Please select --

STATE	SLAVE ID	NAME	IP ADDRESS	PORT	DEVICE
<input type="button" value="Edit"/>					

---

RTU

RS485 Node Address 1, Device Acquisition, 19200 bps, No Parity [Edit RS485](#)

Enabling monitoring of devices connected over Serial Ports

Operating mode Device Acquisition

Add device -- Please select --

STATE	SLAVE ID	NAME	DEVICE
<input type="button" value="Edit"/>			

## Debug Settings

In the **Debug Settings** sub-menu it's possible to enable or disable the Debugging access for FIMER Service purposes.



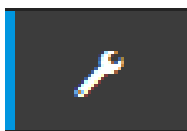

## Service TOOLS

In the **Service TOOLS** section it's possible to access the following sub-menus:

- **Connectivity Check**
- **Country Standard**
- **Firmware Update**
- **Date/Time**
- **Reset Manufacturing** (*Only visible with Admin Plus privileges*)

### Connectivity Check

In the **Connectivity Check** sub-menu it's possible to carry out connectivity tests of the wireless network connection, ethernet connection, connection to Aurora Vision and firmware upgrade servers. At the end of the test it will be reported the detail of the results.

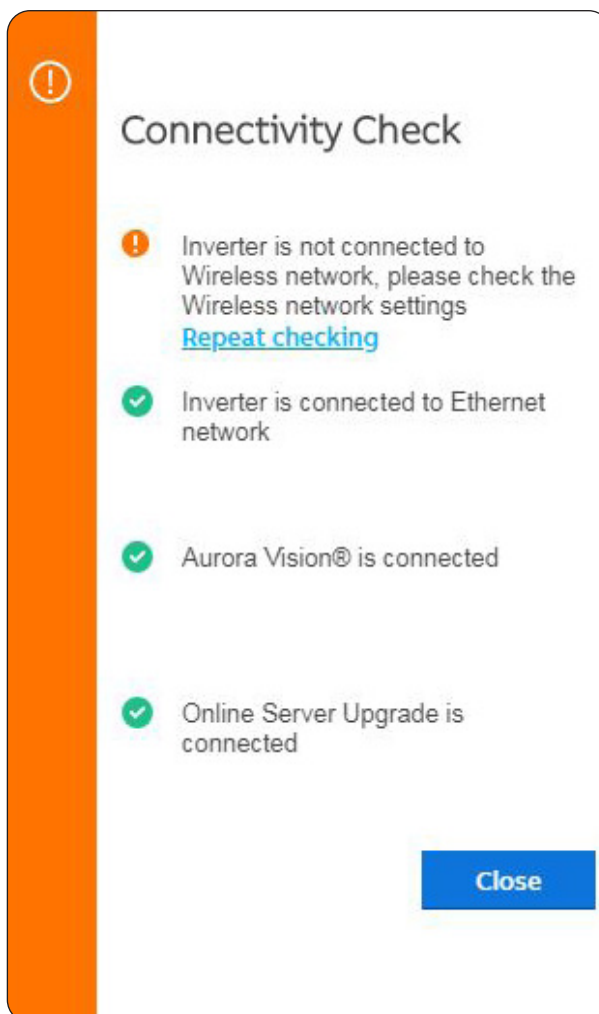



## Country Standard

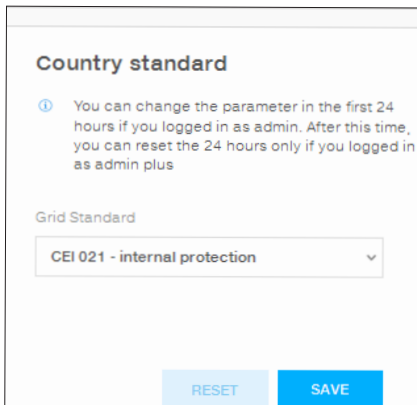

By accessing to the **Country Standard** sub-menu you can modify the grid standard within 24 hours while the inverter is operating.



*After the grid standard was set you have 24 hours to make any changes to the grid standard value; 24 hours later the **Country Standard** sub-menu will be locked, and any subsequent changes can only be made accessing with **Admin Plus** privileges. Refer to the dedicated section on this topic in the manual to know how to unlock the **Country Standard** sub-menu.*

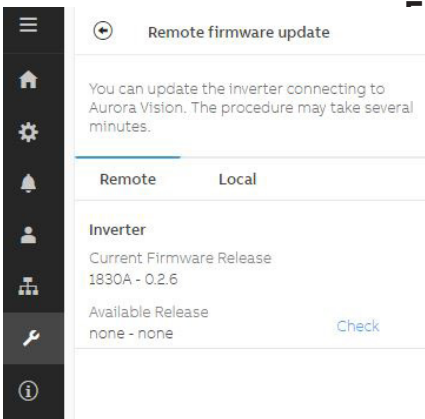

## Firmware Update

By accessing to the **Firmware Update** sub-menu you can upgrade the firmware of the inverter and his components selecting a Remote firmware Update or a Local firmware Update.



*Perform the update during good irradiation conditions (avoid the dawn and dusk hours).  
An interruption of updating process could damage the inverter!*

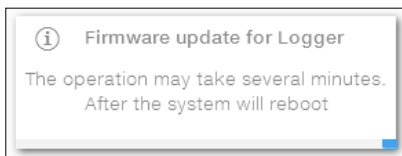
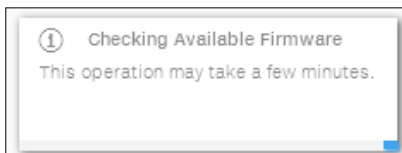

### • Remote firmware Update:

- In remote mode, the firmware will update automatically, searching the last available firmware on FIMER servers, by clicking the “CHECK” button.
- After the finish of the checking process the available release will be notified on the bottom part of the section
- Click on “UPDATE” button to start with the updating process.

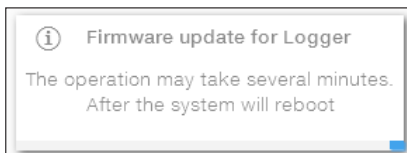
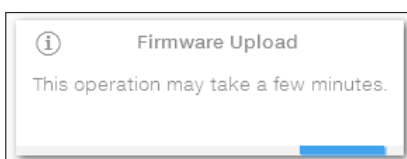

### • Local firmware Update:

- By updating in local mode, the firmware have to be selected and uploaded from local folder of the used devices to access to the web server. The latest firmware version is available from the download area of the website [www.fimer.com](http://www.fimer.com) or from <https://registration.solar.fimer.com>.
- Click on “FW SELECT” and select the firmware package previously downloaded.
  - Click on “UPDATE” button to start with the updating process.



## Date and Time

In the **Date and Time** sub-menu it's possible to set the date, time and time zone.

The inverter will propose these fields when the time protocol is available).

When it's not possible for the inverter to detect the time protocol, these fields have to be manually entered.

### Date and Time

✔ A NTP server has been detected and it will be used to keep the system clock synchronized.

Date ✔

Aug 29, 2018

SET by the NTP server

Time ✔

9:04 AM

SET by the NTP server

Time Zone

Europe/Berlin GMT+01:00 ▼

Save

## Reset Manufacturing (Only visible with Admin Plus privileges)

In the **Reset Manufacturing** sub-menu it's possible to reset country standard, restore default and the connectivity reboot



## Information

In the **INFORMATION** Section it's possible to view the general informations about the embedded Web User Interface.

it's possible to access the following sub-menus:

- **Product Info**
- **Privacy Policy**
- **Provider Information/Impressum**
- **Acknowledgments**
- **Release Notes**

## Inverter switch-off



*Some parts may be very hot and could cause burns.*



*Some inverter parts may be subject to voltages that could be hazardous for the operator. Before performing any work on the inverter, follow the procedure for turning off the inverter.*

## Operator and maintenance personnel skills/prerequisites



*Personnel in charge of using and maintaining the equipment must be skilled for the described tasks and must reliably demonstrate their capacity to correctly interpret what is described in the manual.*



*For safety reasons, only a qualified electrician who has received training and/or demonstrated skills and knowledge of the inverter's structure and operation may install the inverter.*



*The installation must be performed by qualified installers and/or licensed electricians in accordance with the existing regulations in the country of installation and in accordance of all safety rules for performing electrical works.*



*Inverter operation and maintenance by a person who is NOT qualified, is intoxicated, or on narcotics, is strictly forbidden.*



*The customer has civil liability for the qualification and mental or physical state of the personnel who interact with the equipment. They must always use the personal protective equipment (PPE) required by the laws of the country of destination and whatever is provided by their employer.*

### Required tools

- MC4 disconnect tool
- Voltage detector (EN 61243-3)
- DC current clamp
- Safety tags “work in progress, do not operate”
- Padlocks

### Required PPE

- Dielectric helmet EN397 – EN50365 1000V with visor EN166 grade 8
- Insulating gloves class 0 (1000V) EN 60903
- Protective overglove in leather EN420 – EN388 - Alternatively use insulating composite gloves cat. 0 en60903 resistant to electric arc class 2 7ka en61482-1-2)
- Work overall UNI EN 11612 A B1 C1 resistant to electric arc class 2 (7kA 1s.) CEI EN 61482-1-2
- Safety shoes

## Switch-off procedure

### 1. Preliminary checks

- PPE Check: Verify the integrity of the PPE that is going to be used to perform the operations.
- Equipment check: Check the voltage tester is working correctly.

### 2. Wear the appropriate PPE for carrying out the operations (overall resistant to electric arc, dielectric helmet with visor, insulating gloves). All the following activities (till the completion of the procedure) must be performed wearing the PPE.

### 3. Check the absence of dangerous voltages on inverter chassis respect ground:

Check the absence of dangerous voltage on the inverter chassis. The measurement point are between inverter chassis and a ground point outside the REACT2.

### 4. Operations on External AC source

- Disconnect any AC external sources.
- Affix designated lock preventing operation onto any external AC disconnect device, affixing designated tags.
- Check on the status icons (on the synoptic 03) the shutdown command has been carried out: **Missing Grid:** Power icon (Green) Flashing – Alarm icon (Yellow) on (solid).

### 5. Operations on External DC source

*In case of absence of External DC disconnect device go on the point 6 “Operations on Internal DC and battery disconnect switch”*

- Disconnect any DC external sources
- Affix designated lock preventing operation onto any external DC disconnect device, affixing designated tags.

### 6. Operations on Internal DC and battery disconnect switch 07

- Open DC and battery disconnect switch 07.
- Affix padlocks and tags to inhibit the re-closing operation.
- Check on the status icons (on the synoptic 03) the shutdown command has been carried out.

**Missing DC voltage:** All LEDs OFF.

### 7. Remove the DC cables from the PV connectors 06 12

- Using the current clamp check the absence of current on DC side, measurement each positive and negative DC input string(check the correct setting of the current sensor).
- Remove all quick fit DC connectors 06 12 (PV Connector) from the REACT2-UNO. To avoid mechanical interferences, use a cable tie to collect the disconnected cables.

### 8. Discharge of the capacitor

Wait the internal capacitors to be discharged. The discharge time of the stored energy, is indicated on the regulatory label – 5 minutes.

### 9. Voltage absence check on DC side

- Access to the REACT2-UNO by opening the front cover 05.
- Visually inspect the components to identify the presence of any overheating, signs of electric arcs, failure of the insulating devices.

**10. Check the absence of voltage on the DC terminal block using the VAT**

- Check the absence of voltage on the DC terminal block measuring between “Positive-ground”.
- Check the absence of voltage on the DC terminal block measuring between “Negative-ground”.
- In case of absence of voltage between “Positive-ground” and “Negative-ground” check that there is no voltage on the all DC branches coming from the photovoltaic field, measuring between all the points: +DC input / -DC input.

**11. Voltage absence check on AC side**

Check there is no voltage on the AC output (GRID) screw terminal block 43, measuring between: phase to PE - Neutral to PE - Phase to Neutral

**12. Voltage Absence on DC Bulk Capacitor**

Wait the discharge time indicated on the safety label (5 minutes at least)

**13. Check list to be filled prior the access to the inverter**

Purpose of the checklist is to verify that all the operations mentioned in the procedure have been carried out. The checklist below must be attached to the intervention report.

Check	Status V or X
Prepare for the work and identify the work location and equipment	
PPE and Equipment Check	
PPE wearing	
<b>OPERATIONS AT PLANT LEVEL [*]</b>	
Check the absence of dangerous voltages on inverter chassis respect ground	
Operations in External AC switch	
Operations in External DC Switch	
<b>OPERATIONS AT INVERTER LEVEL</b>	
AC disconnect – Inverter Side	
DC disconnects – Inverter Side (opening and LOTO of DC switches in all power compartments)	
Remove the DC cables from the terminal block	
Wait the discharge of the internal capacitor	
<b>VOLTAGE ABSENCE TEST</b>	
Voltage absence check on DC side	
Voltage absence check on AC Side	
Voltage absence on bulk capacitors	
<b>ISSUE WORK PERMIT</b>	
Issue work permit and “Walk the permit” – Check list filling	
== ONLY if all checks are POSITIVE ( ) the ACCESS IS ALLOWED =	

[\*]: Identification of the external switch may require the cooperation of the plant manager and it must be included in the switching plan defined during the preparation of the work.

## General conditions

Routine and periodic maintenance operations must only be carried out by specialized staff with knowledge of how to perform these tasks.



*Maintenance operations must be performed with the apparatus disconnected from the grid (power switch open) and the photovoltaic panels obscured or isolated, unless otherwise indicated.*



*For cleaning, DO NOT use rags made of filamentary material or corrosive products that may corrode the equipment or generate electrostatic charges.  
Avoid temporary repairs. All repairs should be carried out using only genuine spare parts.  
The maintenance technician is to promptly report any anomalies.*

DO NOT allow the equipment to be used if problems of any kind are found.



*Always use personal protective equipment (PPE) provided by the employer and comply with local safety regulations.*





## Routine maintenance

Routine maintenance operations should not be considered obligatory, but rather as recommended in order to maintain the efficiency of the PV system.

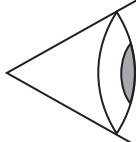

*It is recommended that maintenance operations are only performed by qualified personnel or personnel (under a servicing contract).*

*The maintenance schedule may vary depending on the environmental conditions of the installation premises.*

Type/schedule	Description of the check/operation
<b>Annual visual checks</b> 	<ul style="list-style-type: none"> <li>• Check that the system is operating properly, without any alarm signals</li> <li>• Ensure all labels and safety symbols are visible</li> <li>• Check the integrity of the cables, connectors and external cable glands</li> <li>• Check that the environmental conditions have not changed dramatically from those on installation.</li> </ul>
<b>Annual operations</b> 	<ul style="list-style-type: none"> <li>• Check the tightening of the cable glands and the screw terminal blocks</li> <li>• Check the front covers are fixed</li> <li>• If there is no monitoring system, check the alarms and errors log using the information provided in the manual in order to check recent notifications of malfunctions.</li> </ul>
<b>Annual cleaning</b> 	<ul style="list-style-type: none"> <li>• Clean the equipment; in particular the heat sink and the ventilation openings on the REACT2-BATT</li> </ul>

## Troubleshooting

In order to understand and deal with warning (Wxxx) or error (Exxx) signals, use the table given in the following paragraph.











*Operations on the inverter to identify and address any faults may only be performed by the installer or by qualified personnel.*

## Alarm Messages













The equipment can notify errors/warnings and can be checked via web server user interface.

The following table gives the complete list of errors/warnings relating to string inverters. Some error/warning codes may not be used depending on the inverter model installed.

- Error code - Error message - Warning	Name of Alarm and Cause	Solution
- No code - Ground F -  (On)	<b>Ground fault of photovoltaic generator:</b> The alarm is generated when a ground leakage current is detected in the DC section of the system.	<ul style="list-style-type: none"> <li>• Measure the insulation resistance using a megohmmeter positioned in the photovoltaic field (positive terminal short-circuited at the negative pole) compared to ground. The measurement is strongly influenced by the environmental conditions, so must be made under the same conditions in which the error occurred.</li> <li>- If the value measured is lower than 1 megaohm, a check must be carried out by a technician/installer on the photovoltaic generator to identify and eliminate the problem.</li> <li>- If the value measured is higher than 1 megaohm and the error signal persists, contact customer assistance.</li> </ul>
- No code - Missing Grid -  (On)	<b>Missing Grid:</b> The inverter does not detect grid voltage (AC side).	<ul style="list-style-type: none"> <li>• Check the grid voltage on the inverter's AC terminal block.</li> <li>- Should it be absent, check any protection work on the line and the presence of grid voltage on the supply point.</li> </ul>
- No code - Memory fault -  (flashing slow)	<b>Memory fault:</b> The inverter has detected a communication problem with the memory board on which the inverter saves the daily value of energy produced.	<ul style="list-style-type: none"> <li>• Remove the memory board and check the welding of all the connector's terminals. Subsequently reinsert the memory board and check that it is correctly inserted into the dedicated slot</li> <li>- If the signal persists also following the above checks, contact customer assistance.</li> </ul>
- No code - Waiting Sun -  (flashing slow)	<b>Waiting Sun:</b> The inverter goes into the "Waiting Sun" stage when, following a W001 and/or W002 warning, the voltage from the photovoltaic generator is less than the activation voltage (Vstart).	<ul style="list-style-type: none"> <li>• Check the input voltage on the inverter.</li> <li>- If it does not exceed Vstart, check for the presence of sufficient irradiation and the correct composition of the system.</li> <li>- If it exceeds Vstart, contact customer assistance</li> </ul>
- W001 - Sun Low -  (On)	<b>Insufficient irradiation (Low input voltage on switching on the inverter):</b> Incorrect configuration of the PV generator or an "on the limit" configuration for the inverter's minimum input voltage.	<ul style="list-style-type: none"> <li>• Check the input voltage on the inverter.</li> <li>- If it does not exceed Vstart, check for the presence of sufficient irradiation and the correct composition of the system.</li> <li>- If it exceeds Vstart, contact customer assistance</li> </ul>
- W002 - Input UV -  (On)	<b>Insufficient irradiation (Low input voltage on switching off):</b> Incorrect configuration of the photovoltaic generator or an "on the limit" configuration for the inverter's minimum input voltage.	<ul style="list-style-type: none"> <li>• Check the input voltage on the inverter.</li> <li>- If it does not exceed Vstart, check for the presence of sufficient irradiation and the correct composition of the system.</li> <li>- If it exceeds Vstart, contact customer assistance</li> </ul>
- W004 - Grid OV -  (On)	<b>Grid overvoltage:</b> This error signal occurs when during the inverter's normal operation the grid voltage exceeds the maximum limit set by the operator.	<ul style="list-style-type: none"> <li>• Check the grid voltage on the inverter.</li> <li>If the voltage tends to rise (when the inverter is connected), there is a problem of high line or grid impedance.</li> <li>• Check the grid voltage also on the supply.</li> <li>- If it is high, it means that there is high grid impedance. In this case, ask the operator to adjust the grid voltage. If the operator authorises a change to the inverter's parameters, agree the new limits with customer assistance</li> <li>- If the voltage at the point of supply is much lower than that measured on the inverter, it is necessary to adjust the line (inverter-contactor).</li> <li>- If the voltage and the grid frequency come back within the limits (also when the inverter is connected to the grid), contact customer assistance</li> </ul>
- W005 - Grid UV -  (On)	<b>Grid undervoltage:</b> This error signal occurs when during the inverter's normal operation the grid voltage exceeds the minimum limit set by the operator.	<ul style="list-style-type: none"> <li>• Check the grid voltage on the inverter.</li> <li>• Check the grid voltage also on the supply.</li> <li>- If it is high, it means that there is high grid impedance. In this case, ask the operator to adjust the grid voltage. If the operator authorises a change to the inverter's parameters, agree the new limits with customer assistance</li> <li>- If the voltage at the point of supply is much lower than that measured on the inverter, it is necessary to adjust the line (inverter-contactor).</li> <li>- If the voltage and the grid frequency come back within the limits (also when the inverter is connected to the grid), contact customer assistance</li> </ul>











- Error code - Error message - Warning	Name of Alarm and Cause	Solution
- W006 - Grid OF - ⚠️ (On)	<b>Grid over-frequency:</b> This error signal occurs when during the inverter's normal operation the grid frequency exceeds the maximum limit set by the operator.	<ul style="list-style-type: none"> <li>• Check the grid frequency in the inverter.</li> <li>• Check the grid frequency also on the supply:</li> <li>- If the voltage and the grid frequency come back within the limits (also when the inverter is connected to the grid), contact customer assistance</li> </ul>
- W007 - Grid UF - ⚠️ (On)	<b>Grid under-frequency:</b> This error signal occurs when during the inverter's normal operation the grid frequency exceeds the minimum limit set by the operator.	<ul style="list-style-type: none"> <li>• Check the grid frequency in the inverter.</li> <li>• Check the grid frequency also on the supply:</li> <li>- If the voltage and the grid frequency come back within the limits (also when the inverter is connected to the grid), contact customer assistance</li> </ul>
- W010 - Fan Fail - ⚠️ (flashing slow)	<b>Fan Fail:</b> This error occurs when there is a malfunction in the fan/fans inside the inverter.	<ul style="list-style-type: none"> <li>• Error inside the inverter and cannot be checked externally.</li> <li>- If the alarm repeats persistently, contact customer assistance.</li> </ul>
- W011 - Bulk UV - ⚠️ (On)	<b>Low "Bulk" voltage (DC-DC circuit):</b> The alarm (which is a warning and not an error) is generated when the voltage at the heads of the bulk capacitors does not reach the threshold for the operation of the inverter (internal unchangeable threshold).	<ul style="list-style-type: none"> <li>• Raise the value of the activation voltage (Vstart) so as to have sufficient power from the PV generator at the time of the inverter's grid connection.</li> <li>• Check the input voltage on the inverter.</li> <li>- If it does not exceed Vstart, check for the presence of sufficient irradiation and the correct composition of the system.</li> <li>- If it exceeds Vstart, contact customer assistance.</li> </ul>
- W012 - Batt. Low - ⚠️ (flashing slow)	<b>Battery Low:</b> The inverter has detected a backup battery voltage that is too low.	<ul style="list-style-type: none"> <li>• Check that the date/time are set correctly and, if they are not, set them.</li> <li>Subsequently arrange to completely switch off the inverter (on both AC and DC) and wait a few minutes.</li> <li>Finally, restart the inverter and check whether the date/time are now correctly set or whether they have reset to 01/01/2000. In this case replace the battery with the inverter completely switched off (isolate AC and DC side) being careful to maintain the polarity</li> </ul>
- W013 - Clock Fail - ⚠️ (flashing slow)	<b>Clock Fail:</b> The alarm occurs when there is a difference of more than 1 minute in the time shown on the web server user interface compared to the internal time of the microprocessors and indicates a malfunction of the clock circuit.	<ul style="list-style-type: none"> <li>• Error inside the inverter and cannot be checked externally.</li> <li>- If the alarm repeats persistently, contact customer assistance.</li> </ul>
- W015 - Island Detect. - ⚠️ (On)	<b>Disconnection due to Anti-Islanding:</b> The inverter has been improperly connected to an island grid.	<ul style="list-style-type: none"> <li>• Check that the grid to which the inverter is connected is not an island grid.</li> <li>- If the grid to which the inverter is connected is an island grid, switch the inverter off and then on again: if the problem persists, contact customer assistance.</li> </ul>
- W022 - Reactive power mode changed - ⊗ No Icon	<b>Variation in means of managing reactive power:</b> Variation in the means of managing reactive power; this change can be made through the web server user interface.	The variation in the means of managing reactive power is done directly by the customer/installer and is not an error. The information is only saved on the historic record of the events memorised by the inverter
- W023 - date/time changed - ⊗ No Icon	<b>Variation in the inverter's date and time:</b> Variation of the inverter's date and time; this change can be made through the web server user interface.	<ul style="list-style-type: none"> <li>• The variation in the inverter's date and time is done directly by the customer/installer and is not an error. The information is only saved on the historic record of the events memorised by the inverter</li> </ul>
- W024 - Energy data reset - ⊗ No Icon	<b>Zeroing of the statistical energy data memorised in the EEPROM:</b> Reset of the energy data saved in the inverter; this change can be made through the web server user interface.	The zeroing of the partial energy values memorised by the inverter is done directly by the customer/installer and is not an error. The information is only saved on the historic record of the events memorised by the inverter <ul style="list-style-type: none"> <li>• The warning may also occur when the Memory Card on which the production statistics are saved is replaced</li> </ul>
- W026 - AFDD user reset - ⊗ No Icon	<b>Reset of the Arc Fault error:</b> Manual reset of the Arc Fault error; this change can be made through the web server user interface.	<ul style="list-style-type: none"> <li>• The reset of the Arc Fault error is done directly by the customer/installer and is not an error. The information is only saved on the historic record of the events memorised by the inverter</li> </ul>
- W030 - Energy Meter ERROR * - ⊗ No Icon	<b>METER device communication problem:</b> Error detected on the RS485 serial communication line between the inverter and the energy meter (METER).	<ul style="list-style-type: none"> <li>• Check the serial communication line connections between the inverter and the METER. Particularly check the signal correspondence, the correct installation of the conductors and that there are no breaks in the cables.</li> <li>• Faulty communication card (Comm. card)</li> <li>• Error inside the inverter and cannot be checked externally.</li> <li>- If the problem persists (once the inverter has been switched off and back on again), contact customer assistance.</li> </ul>

- Error code - Error message - Warning	Name of Alarm and Cause	Solution
- W031 - BMS fault - ☒ No Icon	<b>Battery unit communication problem:</b> Error detected on the internal communication line between the inverter unit and the battery unit.	<ul style="list-style-type: none"> <li>• Check the serial communication line connections between the inverter unit and the battery unit. Particularly check the connectors have been installed correctly and that there are no breaks in the cables connecting the two units.</li> <li>• Error inside the inverter and cannot be checked externally.</li> <li>- If the problem persists (once the inverter has been switched off and back on again), contact customer assistance.</li> </ul>
- W036 - Batt. 1 - W - ☒ No Icon	<b>Problem inside battery unit 1:</b> Problem inside battery unit. This condition can be transitory with automatic reset at the end of the alarm situation	<ul style="list-style-type: none"> <li>• Error inside the inverter and cannot be checked externally.</li> <li>- If the problem persists (once the inverter has been switched off and back on again), contact customer assistance.</li> </ul>
- W037 - Batt. 1 - F1 - ☒ No Icon	<b>Error inside battery unit 1:</b> Problem inside battery unit. This condition can be transitory with automatic reset at the end of the alarm situation	<ul style="list-style-type: none"> <li>• Error inside the inverter and cannot be checked externally.</li> <li>- If the problem persists (once the inverter has been switched off and back on again), contact customer assistance.</li> </ul>
- W039 - Batt. 2 - W - ☒ No Icon	<b>Problem inside battery unit 2:</b> Problem inside battery unit. This condition can be transitory with automatic reset at the end of the alarm situation	<ul style="list-style-type: none"> <li>• Error inside the inverter and cannot be checked externally.</li> <li>- If the problem persists (once the inverter has been switched off and back on again), contact customer assistance.</li> </ul>
- W040 - Batt. 2 - F1 - ☒ No Icon	<b>Error inside battery unit 2:</b> Problem inside battery unit. This condition can be transitory with automatic reset at the end of the alarm situation	<ul style="list-style-type: none"> <li>• Error inside the inverter and cannot be checked externally.</li> <li>- If the problem persists (once the inverter has been switched off and back on again), contact customer assistance.</li> </ul>
- W042 - Batt. 3 - W - ☒ No Icon	<b>Problem inside battery unit 3:</b> Problem inside battery unit. This condition can be transitory with automatic reset at the end of the alarm situation	<ul style="list-style-type: none"> <li>• Error inside the inverter and cannot be checked externally.</li> <li>- If the problem persists (once the inverter has been switched off and back on again), contact customer assistance.</li> </ul>
- W043 - Batt. 3 - F1 - ☒ No Icon	<b>Error inside battery unit 3:</b> Problem inside battery unit. This condition can be transitory with automatic reset at the end of the alarm situation	<ul style="list-style-type: none"> <li>• Error inside the inverter and cannot be checked externally.</li> <li>- If the problem persists (once the inverter has been switched off and back on again), contact customer assistance.</li> </ul>
- W045 - Sys disconnected - ⚠ (On)	<b>Disconnection of system from grid:</b> Warning of disconnection of system from electrical grid (no DC input voltage) because of dead battery unit or no demand from domestic loads	<ul style="list-style-type: none"> <li>• Check that, when the warning occurs, the battery unit is dead and/or there have been no energy demands from domestic loads for more than 10 minutes.</li> </ul>
- W046 - Grid conn. fault - ⚠ (On)	<b>Connection to the grid unsuccessful</b> The alarm is logged when a Missing grid or Input UV error occurs or due to the manual disconnection of the inverter during the grid connection sequence.	<ul style="list-style-type: none"> <li>• Once the error occurs, the inverter tries to return to normal operation.</li> <li>If the problem persists after a number of attempts to connect the inverter, switch the inverter off and then on again.</li> <li>- If the problem persists (once the inverter has been switched off and back on again), contact customer assistance.</li> </ul>
- W047 - Update Incomplete - ⚠ (On)	<b>FW update method unsuccessful</b> The alarm occurs when a firmware update has not been completed.	<ul style="list-style-type: none"> <li>• Complete any pending firmware updates.</li> <li>- If the problem persists once the firmware updates have been completed, switch the inverter off and on again.</li> <li>- If the problem persists (once the inverter has been switched off and back on again), contact customer assistance.</li> </ul>
- W048 - Periodic GridOff - ⚠ (On)	<b>Automatic disconnection from the grid due to time limit:</b> If the inverter exceeds the set grid connection time limit set by the grid standard, it will automatically have to carry out a disconnection and reconnection to the grid to carry out the Riso test.	<ul style="list-style-type: none"> <li>• The presence of this alarm is not an error as the automatic disconnection is prescribed by safety regulations.</li> <li>- If the inverter disconnects in a shorter time than expected, contact customer assistance.</li> </ul>
- W049 - Global-Settings Event - ☒ No Icon	<b>Variation of the grid standard</b> Variation of the inverter's grid standard; this change can be made through the web server user interface.	<ul style="list-style-type: none"> <li>• The variation in the inverter's grid standard is done directly by the customer/installer and is not an error. The information is only saved on the historic record of the events memorised by the inverter</li> </ul>
- W051 - Exit from Backup connection - ⚠ (On)	<b>Exit from Backup mode:</b> The alarm is logged when the "Backup" mode is deactivated or the inverter reconnects to the grid.	<ul style="list-style-type: none"> <li>• Deactivation of the Backup mode is done directly by the customer/installer or automatically by the inverter and is not an error.</li> </ul>
- W053 - SOH Low - ⚠ (flashing slow)	<b>State of health (SOH) of battery unit low:</b> Indicates an accelerated deterioration of the battery	<ul style="list-style-type: none"> <li>• Check that the installation requirements are met (temperature, minimum air volume, etc.).</li> </ul>

- Error code - Error message - Warning	Name of Alarm and Cause	Solution
- W054 - SOH Low ( Fault ) -  (flashing slow)	<b>Battery unit blocked through low state of health (SOH):</b> Indicates that the SOH level of the battery unit (during normal operation) is below the threshold for use. The alarm is displayed for SOH values below 60%.	<ul style="list-style-type: none"> <li>• Indicates that the useful life of the battery is over and it must be replaced.</li> </ul>
- W055 - Battery Low ( 0% ) - 	<b>State of charge (SOC) of battery unit low:</b> Indicates that the battery is completely dead.	<ul style="list-style-type: none"> <li>• Where permitted by the regulations of the country where it is installed, it is advisable to force the battery to recharge using the electrical grid (charge in AC). Otherwise it is necessary to have good energy production and low absorption of domestic loads to carry out the recharging of the battery (charge in DC).</li> </ul>
- W056 - Power Engage -  (On)	<b>Problem with battery unit (power) connection cables:</b> Error detected on the power cables between the inverter unit and the battery unit.	<ul style="list-style-type: none"> <li>• Check the power line connections between the inverter unit and the battery unit. Particularly check the connectors have been installed correctly and that there are no breaks in the cables connecting the two units.</li> <li>• Error inside the inverter and cannot be checked externally.</li> <li>- If the problem persists (once the inverter has been switched off and back on again), contact customer assistance.</li> </ul>
- W059 - Output power Overload -  (On)	<b>Overload on Backup output:</b> The alarm occurs when there is an excessive request for power by the grid with the inverter in "Backup" mode.	<ul style="list-style-type: none"> <li>• Disconnect one or more loads from the Backup output.</li> <li>- If the problem persists (once all loads have been disconnected and the inverter has been switched off and back on again), contact customer assistance.</li> </ul>
- W060 - COMMISSIONING - SOH test - Warning - 	<b>State of health (SOH) of battery unit low:</b> Indicates that the SOH level of the battery unit (during system commissioning) is close to the threshold below which it cannot be used. The alarm is displayed for SOH values between 51 and 60%.	<ul style="list-style-type: none"> <li>• Indicates that the useful life of the battery is about to end as with SOH values of below 50% it should be replaced.</li> </ul>
- W061 - COMMISSIONING - SOH test - Fault - 	<b>Battery unit blocked through low state of health (SOH):</b> Indicates that the SOH level of the battery unit (during system commissioning) is below the threshold for use. The alarm is displayed for SOH values below 50%.	<ul style="list-style-type: none"> <li>• Indicates that the useful life of the battery is over and it must be replaced.</li> </ul>
- W062 - BMS Shutdown err - 	<b>Disconnection of the battery did not occur:</b> Impossible to disconnect the battery unit (via the system's internal devices) following a command (automatic or manual).	<ul style="list-style-type: none"> <li>• Error inside the inverter and cannot be checked externally.</li> <li>- If the problem persists (once the inverter has been switched off and back on again), contact customer assistance.</li> </ul>
- W063 - Force Grid Disconnection for Backup Request -  (On)	<b>Forced disconnection from grid:</b> The inverter disconnects from the grid following a command input in Backup mode	<ul style="list-style-type: none"> <li>• This warning is not of an error but is a message informing that the inverter has been forced to disconnect from the grid to go into Backup mode</li> </ul>
W064 - Battery Firmware Update Failed -  (flashing slow)	<b>Update of battery unit firmware failed:</b> Indicates that the update of battery unit firmware has failed.	<ul style="list-style-type: none"> <li>• Redo the battery unit firmware update procedure.</li> <li>If the error warning is shown again contact customer assistance to check the new firmware's compatibility.</li> </ul>
- E001 - Input OC -  (On)	<b>Input over-current (photovoltaic generator):</b> The alarm occurs when the inverter's input current exceeds the inverter's threshold for maximum input current.	<ul style="list-style-type: none"> <li>• Check whether the composition of the PV generator enables input current which exceeds the maximum threshold allowed by the inverter and that the configuration of the inputs (independent or in parallel) is carried out correctly.</li> <li>- If both checks are positive, contact customer assistance.</li> </ul>
- E002 - Input OV -  (On)	<b>Input overvoltage (photovoltaic generator):</b> The alarm is generated when the input voltage (from the PV generator) exceeds the inverter's threshold of maximum input voltage.  The alarm is triggered before reaching the absolute threshold beyond which the inverter will be damaged.  When the inverter's input voltage exceeds the Over Voltage threshold, the inverter will not start up due to the generation of the alarm.	<ul style="list-style-type: none"> <li>• It is necessary to measure the input voltage inside the inverter with a voltmeter.</li> <li>- If it is higher than the maximum voltage of the operating range, the alarm is genuine and it is necessary to check the configuration of the PV generator. If the voltage has also exceeded the maximum input threshold the inverter could be damaged.</li> <li>- If it is lower than the maximum voltage of the operating range, the alarm is caused by an internal malfunction and it is necessary to contact customer assistance.</li> </ul>
- E003 - No Parameters -  (On)	<b>DSP initialisation error:</b> The main microcontroller is unable to correctly initialize the two DSPs (booster stage and inverter stage). The error is caused by communication problems on the inverter's internal bus.	<ul style="list-style-type: none"> <li>• Error inside the inverter and cannot be checked externally.</li> <li>- If the problem persists (once the inverter has been switched off and back on again), contact customer assistance.</li> </ul>

- Error code - Error message - Warning	Name of Alarm and Cause	Solution
- E004 - Bulk OV - ⚠ (On)	<b>“Bulk” over-voltage (DC-DC circuit):</b> Error inside the inverter. The alarm is raised when the voltage at the heads of the bulk capacitors exceeds the Over Voltage threshold (internal unchangeable threshold).	<ul style="list-style-type: none"> <li>• The alarm may be triggered by causes external to the inverter:               <ul style="list-style-type: none"> <li>- An excessive input voltage can be recorded as a condition for bulk over voltage. In this case it is advisable to check the inverter's input voltage and should this value be close to the input OV threshold, review the configuration of the photovoltaic generator.</li> <li>- Excessive grid voltage could cause the bulk voltage to rise in uncontrolled fashion with a consequent protection intervention and hence generation of the alarm. In these cases the alarm is transitory and the inverter automatically restarts</li> </ul> </li> <li>• The alarm may be triggered by causes inside the inverter and in this case it is necessary to contact customer assistance.</li> </ul>
- E005 - Comm.Error - ⚠ (On)	<b>Communication error inside the inverter:</b> The alarm occurs when there are communication problems between the control devices inside the inverter.	<ul style="list-style-type: none"> <li>• Error inside the inverter and cannot be checked externally.</li> <li>- If the problem persists (once the inverter has been switched off and back on again), contact customer assistance.</li> </ul>
- E006 - Output OC - ⚠ (On)	<b>Output overcurrent:</b> The alarm occurs when the inverter's output current exceeds the inverter's threshold for maximum output current.	<ul style="list-style-type: none"> <li>• Error inside the inverter and cannot be checked externally.</li> <li>- If the problem persists (once the inverter has been switched off and back on again), contact customer assistance.</li> </ul>
- E007 - IGBT Sat - ⚠ (On)	<b>Saturation recorded on the IGBT components:</b> The alarm appears when one of the active devices of the inverter is in saturation state.	Once the error appears, the inverter attempts to resume normal operation. <ul style="list-style-type: none"> <li>- Should the error occur sporadically, it may be caused by a brusque transition of the grid voltage or of the input voltage, but is not due to a malfunction by the inverter.</li> <li>- If the error is connected to an internal fault, it will continue to appear and so it is necessary to contact customer assistance.</li> </ul>
- E010 - Bulk Low - ⚠ (On)	<b>Low “Bulk” voltage (DC-DC circuit):</b> The alarm can be caused by causes external to the inverter: a reduced input voltage on the inverter (just above the activation voltage) but which is not accompanied by a sufficient availability of power from the photovoltaic generator (typical condition of the stages with limited irradiation)	<ul style="list-style-type: none"> <li>- If the error signal occurs sporadically, it may be due to causes external to the inverter (limited irradiation and so limited power availability from the PV generator).</li> <li>- If the problem occurs systematically even in conditions of high irradiation and with input voltage which is significantly higher than the activation voltage, contact customer assistance.</li> </ul>
- E011 - Ramp Fail - ⚠ (On)	<b>Long wait for “Booster” regime to start:</b> Error internal to inverter relating to start up time for DC-DC circuit regime (Booster)	<ul style="list-style-type: none"> <li>• Error inside the inverter and cannot be checked externally.</li> <li>- If the problem persists (once the inverter has been switched off and back on again), contact customer assistance.</li> </ul>
- E012 - DcDc Fail - ⚠ (On)	<b>Error in the “Booster” circuit (DC-DC side) recorded by the “Inverter” circuit (DC-AC side):</b> Error inside the inverter regarding the operation of the DC-DC circuit part (Booster).	<ul style="list-style-type: none"> <li>• Error inside the inverter and cannot be checked externally.</li> <li>- If the problem persists (once the inverter has been switched off and back on again), contact customer assistance.</li> </ul>
- E013 - Wrong Mode - ⚠ (On)	<b>Incorrect configuration of inputs (set in parallel rather than independent):</b> The alarm is generated solely when the inverter is configured with parallel inputs. In this particular configuration the inverter checks the input voltage of each of the two channels and if the two voltages differ by more than 20Vdc, the alarm is raised .	<ul style="list-style-type: none"> <li>• Check that the setting of the "IN MODE" switch is specifically set to "PAR" and that the jumpers between the two input channels have been included.</li> <li>- If the configuration of the inverter is correct, check that the input strings have the usual number of standard panels of the usual brand and with the same inclination/orientation.</li> <li>- If both the configuration of the inverter and the characteristics of the PV generator conform with the specifications, contact customer assistance.</li> </ul>
- E014 - Over Temp. - ⚠ (On)	<b>Excessive temperature inside the inverter:</b> External temperature over 60°C. This parameter also depends on the power which the inverter must supply since the measurement of temperatures is done internally and is influenced by the heat dissipated by the components of the inverter itself	<ul style="list-style-type: none"> <li>• Check that the inverter is not exposed to direct sunlight. Wait for the temperatures to which the inverter is exposed to return to the operating range and for the inverter to cool down.</li> <li>- If the problem persists (once the ambient temperature has returned to within the range), contact customer assistance. You must remember to wait for the time necessary to allow the inverter to cool down.</li> </ul>
- E015 - Bulk Cap Fail - ⚠ (On)	<b>Fault recorded on the “Bulk” capacitor:</b> Error inside the inverter regarding a problem in the bulk capacitors.	<ul style="list-style-type: none"> <li>• Error inside the inverter and cannot be checked externally.</li> <li>- If the problem persists (once the inverter has been switched off and back on again), contact customer assistance.</li> </ul>
- E016 - Inverter Fail - ⚠ (On)	<b>Error in the “Inverter” circuit (DC-AC side) recorded by the “Booster” circuit (DC-DC side):</b> The alarm is generated when a problem is detected in the inverter circuit part (DC/AC).	<ul style="list-style-type: none"> <li>• Error inside the inverter and cannot be checked externally.</li> <li>- If the problem persists (once the inverter has been switched off and back on again), contact customer assistance.</li> </ul>

- Error code - Error message - Warning	Name of Alarm and Cause	Solution
- E017 - Start Timeout - ⚠ (On)	<b>Long wait for “Inverter” regime to start up:</b> Error internal to inverter relating to start-up time for the DC-AC circuit regime (Inverter) The alarm can be caused by causes external to the inverter: a reduced input voltage on the inverter (just above the activation voltage) but which is not accompanied by a sufficient availability of power from the photovoltaic generator (typical condition of the stages with limited irradiation)	- If the error signal occurs sporadically, it may be due to causes external to the inverter (limited irradiation and so limited power availability from the PV generator). - If the problem occurs systematically even in conditions of high irradiation and with input voltage which is significantly higher than the activation voltage, contact customer assistance.
- E018 - Ground Fault - ⚠ (On)	<b>High leakage current measured on the DC side (photovoltaic generator):</b> The alarm is generated when, during normal operation of the inverter, a ground leakage current is detected in the DC section of the system. It is also possible that the inverter generates the alarm E018 message also due to AC leakage currents connected to the capacitive nature of the photovoltaic generator compared to ground.	• Measure the insulation resistance using a megohmmeter positioned in the photovoltaic field (positive terminal short-circuited at the negative pole) compared to ground. The measurement is strongly influenced by the environmental conditions, so must be made under the same conditions in which the error occurred. - If the value measured is lower than 1 megaohm, a check must be carried out by a technician/installer on the photovoltaic generator to identify and eliminate the problem. - If the value measured is higher than 1 megaohm and the error signal persists, contact customer assistance.
- E019 - Leak sense.fail - ⚠ (On)	<b>Failure of test on sensor to measure the leakage current (DC side):</b> Before connecting to the grid the inverter runs an autotest regarding the sensor for the leakage current. The test is carried out by “forcing”, in the sensor of the leakage current, a current with a known value: the microprocessor compares the value read with the known value. The error is generated if the comparison between the read value and the known value during the test does not fall within the allowed tolerance.	• Error inside the inverter and cannot be checked externally. By its nature, the alarm only occurs prior to connection to the grid - If the problem persists (once the inverter has been switched off and back on again), contact customer assistance.
- E020 - Self Test Error 1 - ⚠ (On)	<b>Failure of the test on the relay of the “Booster” (DC-DC circuit):</b> Before connecting to the grid, the inverter carries out some internal tests. One of these tests concerns the correct operation of the booster relay. The test is carried out by “forcing” the switching of the relay and checking its operation. The error is generated if a problem is found in actioning the relay.	• Error inside the inverter and cannot be checked externally. By its nature, the alarm only occurs prior to connection to the grid - If the problem persists (once the inverter has been switched off and back on again), contact customer assistance.
- E021 - Self Test Error 2 - ⚠ (On)	<b>Failure of the test on the inverter's relay (DC-AC circuit):</b> Before connecting to the grid, the inverter carries out some internal tests. One of these tests concerns the correct operation of the inverter relay. The test is carried out by “forcing” the switching of the relay and checking its operation. The error is generated if a problem is found in actioning the relay.	• Error inside the inverter and cannot be checked externally. By its nature, the alarm only occurs prior to connection to the grid - If the problem persists (once the inverter has been switched off and back on again), contact customer assistance.
- E022 - Self Test Error 4 - ⚠ (On)	<b>Timeout of the tests undertaken on the relays inside the inverter:</b> Execution time for the autotest carried out on the relay of the DC_AC (inverter) circuit too high. It may indicate a problem connected to the aforementioned relays	• Error inside the inverter and cannot be checked externally. - If the problem persists (once the inverter has been switched off and back on again), contact customer assistance.
- E023 - DC in error - ⚠ (On)	<b>Feeding of direct current to grid outside of range:</b> The error is generated if the direct component of the current supplied to the grid exceeds the threshold of 0.5% of the rated operating current. In any case, the inverter does not stop because of the E023 error, but tries to connect to the grid again. The sporadic repetition of the error is a sign of serious grid distortions or sharp irradiation changes, while systematic repetition of the error signal will indicate a fault in the inverter	Once the error appears, the inverter attempts to resume normal operation. - Should the error occur sporadically, it may be caused by a brusque transition of the grid voltage or of the input voltage, but is not due to a malfunction by the inverter. - If the error is connected to an internal fault, it will continue to appear and so it is necessary to contact customer assistance.

- Error code - Error message - Warning	Name of Alarm and Cause	Solution
- E025 - Riso Low -  (On)	<b>Low value of insulation resistance:</b> Before connecting to the grid the inverter measures the insulation resistance of the PV generator compared to ground. Should the measurement of the insulation resistance be below 1Mohm, the inverter does not connect to the grid and shows the "Riso Low" error. The causes may be: - Damaged PV panel(s). - Junction box(es) of the panels not correctly sealed, so as to permit infiltration by water and/or humidity; - Problems in connections between panels (not perfectly fit); - Poor quality of cable joints; - Presence in the DC section of unsuitable or damaged overvoltage surge arresters outside the inverter (reduced ignition voltage compared to the characteristics of the strings of the PV generator); - Presence of humidity inside any junction box	<ul style="list-style-type: none"> <li>• Measure the insulation resistance using a megohmmeter positioned in the photovoltaic field (positive terminal short-circuited at the negative pole) compared to ground. The measurement is strongly influenced by the environmental conditions, so must be made under the same conditions in which the error occurred.</li> <li>- If the value measured is lower than 1 megaohm, a check must be carried out by a technician/installer on the photovoltaic generator to identify and eliminate the problem.</li> <li>- If the value measured is higher than 1 megaohm and the error signal persists, contact customer assistance.</li> </ul>
- E029 - Mid Bulk OV -  (On)	<b>Internal overvoltage on the measurement of the "Mid bulk":</b> Error inside the inverter (only triphase models)	<ul style="list-style-type: none"> <li>• Error inside the inverter and cannot be checked externally.</li> <li>- If the problem persists (once the inverter has been switched off and back on again), contact customer assistance.</li> </ul>
- E031 - Error Read V -  (On)	<b>Output relay damaged:</b> Measurement of internal voltage on heads of the output relay outside of range. There is too great a difference in voltage between the input and output of the grid connection relay.	<ul style="list-style-type: none"> <li>• Error inside the inverter and cannot be checked externally.</li> <li>- If the problem persists (once the inverter has been switched off and back on again), contact customer assistance.</li> </ul>
- E032 - Error Read I -  (On)	<b>Imbalanced output currents:</b> Measurement of the unbalance in the output voltage (made across the three phases) outside of range (only in three-phase models)	<ul style="list-style-type: none"> <li>• Error inside the inverter and cannot be checked externally.</li> <li>- If the problem persists (once the inverter has been switched off and back on again), contact customer assistance.</li> </ul>
- E033 - UTH -  (On)	<b>Low ambient temperature:</b> Temperature outside the inverter below -25°C	<ul style="list-style-type: none"> <li>• Wait for the temperatures to which the inverter is exposed to return to the operating range.</li> <li>- If the problem persists, contact customer assistance. You must remember to wait for the time necessary to allow the inverter to warm up.</li> </ul>
- E034 - Interlock fail -  (On)	<b>"IGBT" circuitry not ready:</b> Error inside the inverter	<ul style="list-style-type: none"> <li>• Error inside the inverter and cannot be checked externally.</li> <li>- If the problem persists (once the inverter has been switched off and back on again), contact customer assistance.</li> </ul>
- E035* - Remote Off -  (On)	<b>Inverter awaiting "remote ON" command:</b> The inverter has been switched off remotely (remote OFF) and remains in waiting state for the signal that will switch it on again (remote ON).	<ul style="list-style-type: none"> <li>• Switch the inverter back on remotely. If the unit does not switch on, disable the remote on/off function and switch the equipment off completely and then switch it on again.</li> <li>- If the problem persists (once the Remote ON/OFF function has been reactivated), contact customer assistance.</li> </ul>
- E037 - Riso Low -  (On)	<b>Low value of the insulation resistance (only with the "Amorphous" mode activated):</b> This error can appear only if the "Amorphous" mode is enabled. This function is enabled only in inverters equipped with grounding kit and is used to monitor the voltage at the ends of the grounding resistor. The error appears when the voltage at the ends of the resistor connected between ground and pole of the photovoltaic generator exceeds 30V for more than 30 minutes or 120V for more than one second.	<ul style="list-style-type: none"> <li>• Check for the presence and correct contact between the two terminals of the grounding resistance installed inside the inverter</li> <li>• Measure the insulation resistance using a megohmmeter positioned in the photovoltaic field (positive terminal short-circuited at the negative pole) compared to ground. The measurement is strongly influenced by the environmental conditions, so must be made under the same conditions in which the error occurred.</li> <li>- If the value measured is lower than 1 megaohm, a check must be carried out by a technician/installer on the photovoltaic generator to identify and eliminate the problem.</li> <li>- If the value measured is higher than 1 megaohm and the error signal persists, contact customer assistance.</li> </ul>
E049 - AC FF Error -  (On)	<b>Error in the "AC feed-forward" circuit:</b> Error inside the inverter	<ul style="list-style-type: none"> <li>• Error inside the inverter and cannot be checked externally.</li> <li>- If the problem persists (once the inverter has been switched off and back on again), contact customer assistance.</li> </ul>
E067 - Charger - OV -  (On)	<b>Overvoltage of "battery charger" ("Charger" circuit):</b> Error inside the charger (battery unit). The alarm is raised when the battery charger voltage exceeds the overvoltage threshold (internal unchangeable threshold).	<ul style="list-style-type: none"> <li>• If the message persists and is not linked to the battery being disconnected, contact customer assistance.</li> </ul>



- Error code - Error message - Warning	Name of Alarm and Cause	Solution
E068 - Charger - OC - ⚠️ (On)	<b>Overcurrent of "battery charger" ("Charger" circuit):</b> Error inside the charger (battery unit).	<ul style="list-style-type: none"> <li>• Error inside the charger (battery unit) and cannot be checked externally.</li> <li>- If the problem persists, contact customer assistance.</li> </ul>
E069 - Charger-SlowRamp - ⚠️ (On)	<b>Error internal to battery unit charger circuit ("Charger" circuit).</b>	<ul style="list-style-type: none"> <li>• Error inside the charger (battery unit) and cannot be checked externally.</li> <li>- If the problem persists, contact customer assistance.</li> </ul>
E070 - Charger-preChar. - ⚠️ (On)	<b>Error inside the charger (battery unit).</b>	<ul style="list-style-type: none"> <li>• Error inside the charger (battery unit) and cannot be checked externally.</li> <li>- If the problem persists, contact customer assistance.</li> </ul>
E077 - Internal Error - ⚠️ (On)	<b>Error in the system configuration:</b> Error inside the inverter	<ul style="list-style-type: none"> <li>• Error inside the inverter and cannot be checked externally.</li> <li>- If the problem persists (once the inverter has been switched off and back on again), contact customer assistance.</li> </ul>
E078 - Riso Test fail - ⚠️ (On)	<b>Riso test error:</b> Problem detected during the Riso test phase.	<ul style="list-style-type: none"> <li>• Error inside the inverter and cannot be checked externally.</li> <li>- If the problem persists (once the inverter has been switched off and back on again), contact customer assistance.</li> </ul>
E084 - BackFeed OC - ⚠️ (On)	<b>Return current to photovoltaic field:</b> The error occurs if the input voltage is particularly low (typically in the evening in conditions of low irradiation) and indicates a return current from the inverter to the photovoltaic panels).	<ul style="list-style-type: none"> <li>• If the error occurs in the evening or in conditions of low irradiation, it must not be considered a problem but a protection intervention for the photovoltaic field.</li> <li>- If the error occurs with good irradiation conditions, switch the inverter off and back on again; if the error persists, contact customer assistance.</li> </ul>
E086 - Batt. 1 - F2 - ⊗ No Icon	<b>Error battery unit 1 unusable:</b> Indicates that the battery unit is unusable and must be replaced.	<ul style="list-style-type: none"> <li>• Error inside battery unit 1 and cannot be checked externally.</li> <li>- If the problem (once the system has been switched off and back on) persists, contact customer assistance.</li> </ul>
E087 - Batt. 2 - F2 - ⊗ No Icon	<b>Error battery unit 2 unusable:</b> Indicates that the battery unit is unusable and must be replaced.	<ul style="list-style-type: none"> <li>• Error inside battery unit 2 and cannot be checked externally.</li> <li>- If the problem (once the system has been switched off and back on) persists, contact customer assistance.</li> </ul>
E088 - Batt. 3 - F2 - ⊗ No Icon	<b>Error battery unit 3 unusable:</b> Indicates that the battery unit is unusable and must be replaced.	<ul style="list-style-type: none"> <li>• Error inside battery unit 3 and cannot be checked externally.</li> <li>- If the problem (once the system has been switched off and back on) persists, contact customer assistance.</li> </ul>
E089 - Wrong Wiring - ⚠️ (On)	<b>Incorrect grid wiring connection on Backup output:</b> The error occurs if the grid cables have been incorrectly connected to the Backup output.	<ul style="list-style-type: none"> <li>• Check that the cables on the Backup output have been installed correctly.</li> </ul>
E096 - CHARGER - battery UV - ⚠️ (On)	<b>Battery under voltage:</b> The voltage of the battery is too low and need to be charged. In this condition the discharge of the battery is disabled.	<ul style="list-style-type: none"> <li>• The battery will be automatically charged as soon as the condition will allow it.</li> </ul>
E097 - CHARGER - battery HW - ⚠️ (On)	Error inside the battery unit.	<ul style="list-style-type: none"> <li>• Error inside battery unit and cannot be checked externally.</li> <li>- If the problem (once the system has been switched off and back on) persists, contact customer assistance.</li> </ul>

## Power limitation messages

The equipment can signal possible output power limitations which may occur on the basis of:

- settings made by the user
- settings required by the grid standard of the country of installation
- protective devices inside the inverter

The signals and the messages can only be verified using the web server user interface.

*The following table gives the complete list of power limitation messages relating to string inverters.*

*Some messages may not be used depending on the inverter model installed.*

- Web server message - Warning	Name of Derating and Cause	Solution
- LIMxxx% CODE:00	<p><b>Power limitation:</b> The message indicates that the user has set an output power limitation for the inverter. LIM xxx% = Power reduction percentage Examples: LIM 100% = no power limitation LIM 50% = limitation to 50% of the output nominal power</p>	<ul style="list-style-type: none"> <li>• Check the limitation value in “Settings &gt; Power Reduction”.</li> </ul>
- LIMxxx% CODE:01	<p><b>Power limitation due to over-frequency:</b> The message indicates that the user has set a power limitation due to over frequency in order to reduce the maximum output power of the inverter when the grid frequency exceeds certain limits. LIM xxx% = Power reduction percentage Examples: LIM 100% = no power limitation LIM 50% = limitation to 50% of the output nominal power</p>	<ul style="list-style-type: none"> <li>• Check the limitation value set in “Settings &gt; Service Power &gt; OF Derating”</li> </ul>
- LIMxxx% CODE:02	<p><b>Power limitation due to over-voltage:</b> The message indicates that the user has set a power limitation due to overvoltage (parameter U &gt;(10 min)) in order to reduce the maximum output power of the inverter when the reading of the average grid voltage exceeds certain limits. The sampling of readings is done every 10 minutes (U &gt;(10min)). LIM xxx% = Power reduction percentage Examples: LIM 100% = no power limitation LIM 50% = limitation to 50% of the output nominal power</p>	<ul style="list-style-type: none"> <li>• Check the limitation value in “Settings &gt; Service Power &gt; U &gt;(10min) Der.”</li> </ul>
- LIMxxx% CODE:03	<p><b>Anti-islanding power limitation:</b> The message indicates that a power limitation is active because a situation of "islanding" has been recorded. LIM xxx% = Power reduction percentage Examples: LIM 100% = no power limitation LIM 50% = limitation to 50% of the output nominal power</p>	<ul style="list-style-type: none"> <li>• If the inverter remains connected to the grid and the limitation is active, contact customer assistance</li> </ul>
- LIMxxx% CODE:04	<p><b>Power limitation due to low grid voltage:</b> The message indicates that an output power limitation may occur since a low grid voltage (AC) condition has been recorded. LIM xxx% = Power reduction percentage Examples: LIM 100% = no power limitation LIM 50% = limitation to 50% of the output nominal power</p>	<ul style="list-style-type: none"> <li>• Check that the grid voltage is lower than the minimal voltage. If this condition persists, contact the grid operator to resolve the problem.</li> </ul>

- Web server message - Warning	Name of Derating and Cause	Solution
- LIMxxx% CODE:05	<p><b>Power limitation due to excess temperature:</b>            The message indicates that a power limitation is active since an excess temperature condition has been recorded inside the inverter (This parameter depends also on the power which the inverter must provide since the measurement of temperatures is taken internally and is influenced by the heat dissipated by the components of the inverter itself).            LIM xxx% = Power reduction percentage            Examples:            LIM 100% = no power limitation            LIM 50% = limitation to 50% of the output nominal power</p>	<ul style="list-style-type: none"> <li>• Check that the inverter is not exposed to direct sunlight. Wait for the temperatures to which the inverter is exposed to return to the operating range and for the inverter to cool down.</li> <li>- If the problem persists (once the ambient temperature has returned to within the range), contact customer assistance.</li> </ul>
- LIMxxx% CODE:06	<p><b>Power limitation due to input overvoltage:</b>            The message indicates that a power limitation is active since an input overvoltage (DC) has been recorded.            LIM xxx% = Power reduction percentage            Examples:            LIM 100% = no power limitation            LIM 50% = limitation to 50% of the output nominal power</p>	<ul style="list-style-type: none"> <li>• It is necessary to measure the input voltage inside the inverter with a voltmeter.</li> <li>- If it is higher than the maximum voltage of the operating range, the alarm is genuine and it is necessary to check the configuration of the PV generator. If the voltage has also exceeded the maximum input threshold the inverter could be damaged.</li> <li>- If it is lower than the maximum voltage of the operating range, the alarm is caused by an internal malfunction and it is necessary to contact customer assistance.</li> </ul>

## Procedure for dismantling of the REACT2 system

The REACT2 system consists of an inverter unit (REACT2-UNO) and of a battery unit (REACT2-BATT) which may be dismantled separately.



*Perform the steps for “REACT2 system switch-off”, before removing one of the parts making up the system.*

Even though the device is equipped with an anti-condensation valve, air with extremely high levels of humidity can lead to the creation of condensation inside the inverter.

As the inverter is almost completely insulated from the outside, condensation can also form after maintenance interventions.



*Never open the system parts in the case of humidity >95%.  
Always carefully seal all unused openings.*

To dismantling and disassemble the equipment, refer to the chapters:

**Wall installation of the REACT2 system**

**Wall installation of the REACT2-UNO alone**

Follow the indications for the mounting procedure but in the reverse order

## Registration on website and calculation of Admin Plus password

In order to obtain the password needed to access the web server user interface with Admin Plus privileges, it is necessary to go through the following stages:

### Stage 1 - Collection of information relating to the inverter.

Collect the following information relating to each inverter for which you wish to have a password:

- **S/N** - Serial number of the inverter. This information can be found on the label giving the identity details of the inverter or on the display by accessing the "INFORMATION" menu→Serial No." The serial number consists of 6 digits (the last 6 in models with a label giving a 10-digit S/N)
- **WK** - Production week. This information can be found on the label giving the identity details of the inverter or on the display by accessing the "INFORMATION" menu→Serial No." The production week consists of 4 figures, indicating the week (first 2 digits) and the year of production (last 2 digits)

### Stage 2 - Registration on <https://registration.solar.fimer.com>

- Go online and access <https://registration.solar.fimer.com>
- Set the desired language and click on the specific icon to start registration

- Insert the personal data requested and end the registration stage
- An email will be sent to the email address used with a link to complete the registration process.
- Once the registration process is over, a further email will be sent with the password to access the website.

### Stage 3 - Request for second level password

- Go online and access <https://registration.solar.fimer.com>
- Insert the Username (corresponding to the email used during registration) and the Password obtained at the end of Stage 2

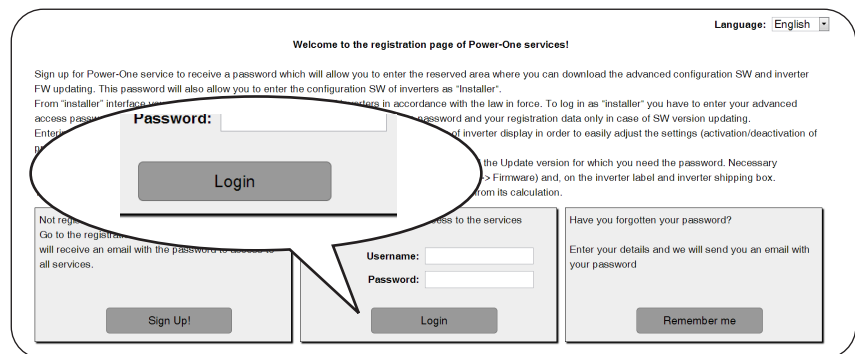

- Access the section dedicated to requesting the password

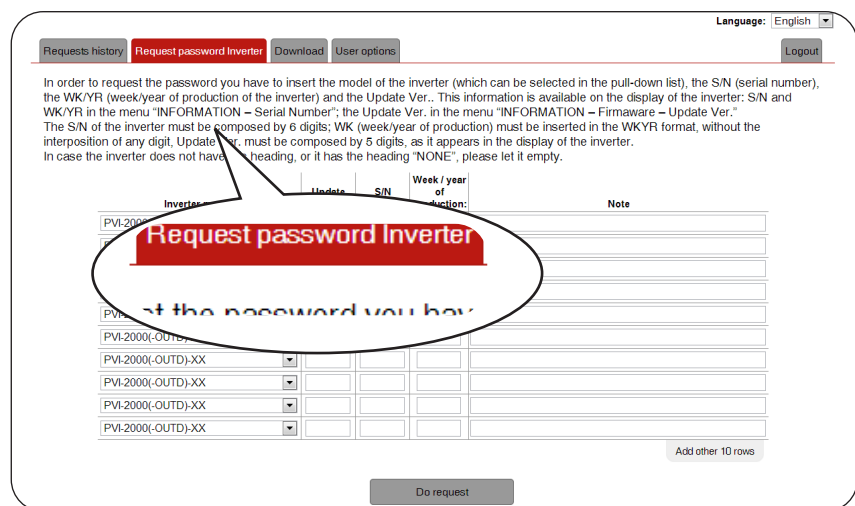

- Choose the inverter model from the drop-down list and insert Serial Number and Week of Production of the inverter which were obtained previously (Stage 1)

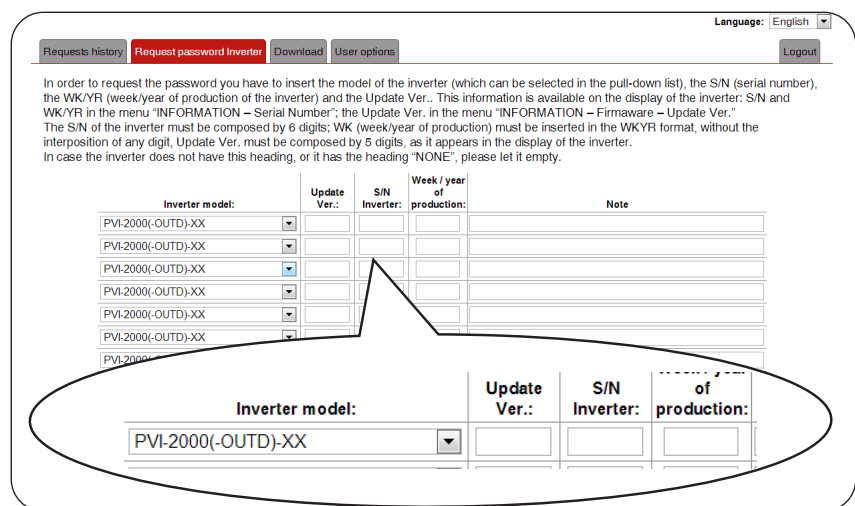

- Click on icon to request password.

Language: English

Requests history **Request password inverter** Download User options Logout

In order to request the password you have to insert the model of the inverter (which can be selected in the pull-down list), the S/N (serial number), the WK/YR (week/year of production of the inverter) and the Update Ver.. This information is available on the display of the inverter: S/N and WK/YR in the menu "INFORMATION – Serial Number"; the Update Ver. in the menu "INFORMATION – Firmware – Update Ver." The S/N of the inverter must be composed by 6 digits; WK (week/year of production) must be inserted in the WK/YR format, without the interposition of any digit, Update Ver. must be composed by 5 digits, as it appears in the display of the inverter. In case the inverter does not have this heading, or it has the heading "NONE", please let it empty.

Inverter model:	Update Ver.:	S/N Inverter:	Week / year of production:	Note
UNO-2.0-I-OUTD	12345	123456	0513	
PVI-3.0-OUTD-XX		987654	0412	
TRIO-27.6-TL-OUTD	13052	564789	4812	
PVI-2000(-OUTD)-XX				
PVI-2000(-OUTD)-XX				
PVI-2000(-OUTD)-XX				
PVI-2000(-OUTD)-XX				
PVI-2000(-OUTD)-XX				
PVI-2000(-OUTD)-XX				
PVI-2000(-OUTD)-XX				

Add other 10 rows

Do request

Should there be an error in inputting data, the fields containing the error will be highlighted in red. If, on the other hand, the data are correct, the passwords will be shown in a new window and at the same time sent to the email address used for registration.



*The password enables access to the Admin Plus privileges which allows the system's sensitive parameters to be changed. Proceed to changing the aforementioned parameters only when requested by the grid operator or by customer assistance.*

## Verification of ground leakage

In the presence of anomalies or report of ground fault (where provided), there may be a ground leakage from the PV generator (DC side).

To check this, measure the voltage between the positive pole and ground and between the negative pole (of the PV generator) and ground using a voltmeter whose input accepts a voltage sufficient for the dimensions of the photovoltaic generator.

### Behaviour of a system without leakage

Due to the capacitive effect of the PV generator, during the first moments that the voltmeter is connected between one of the two poles and ground, it will measure a voltage of about  $V_{oc}/2$ , which will tend to stabilize to around 0V if there is no ground leakage, as shown in the graph below:

The internal resistance of the voltmeter tends to zero the voltage present on the PV generator due to the capacitive effect.

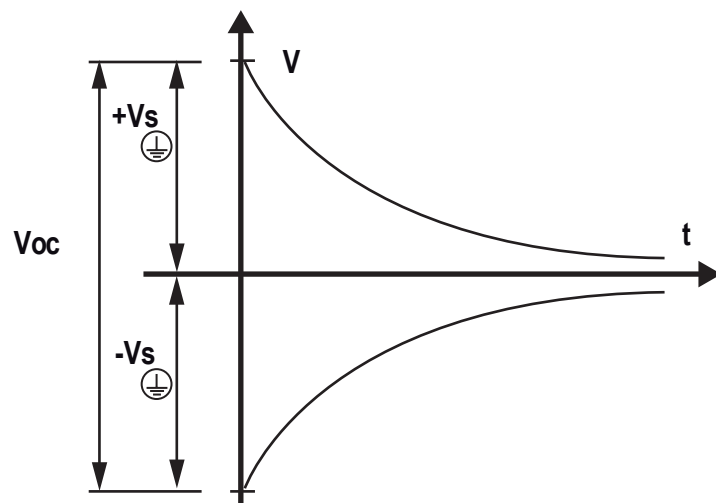

How to make the measurement:

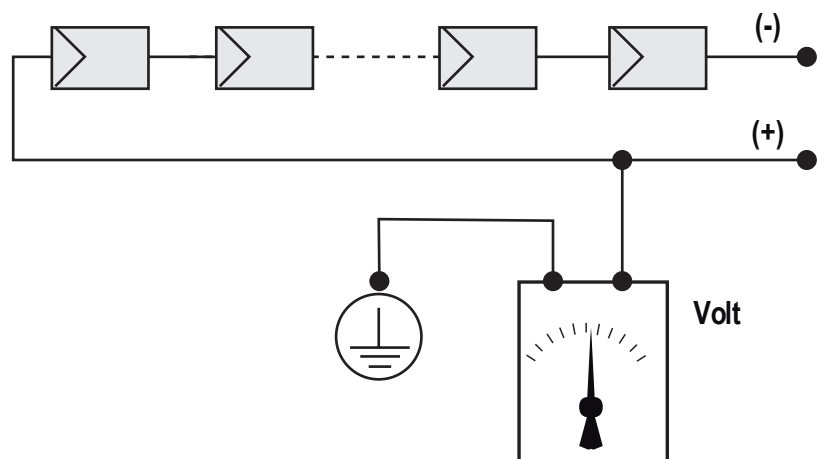



## Behaviour of a system with leakage

If the voltage measured between one of the two poles and ground does not tend to 0V and stabilizes on a value, there is a ground leakage from the PV generator.

Example: When the measurement is made between positive pole and ground, a voltage of 200V is measured.

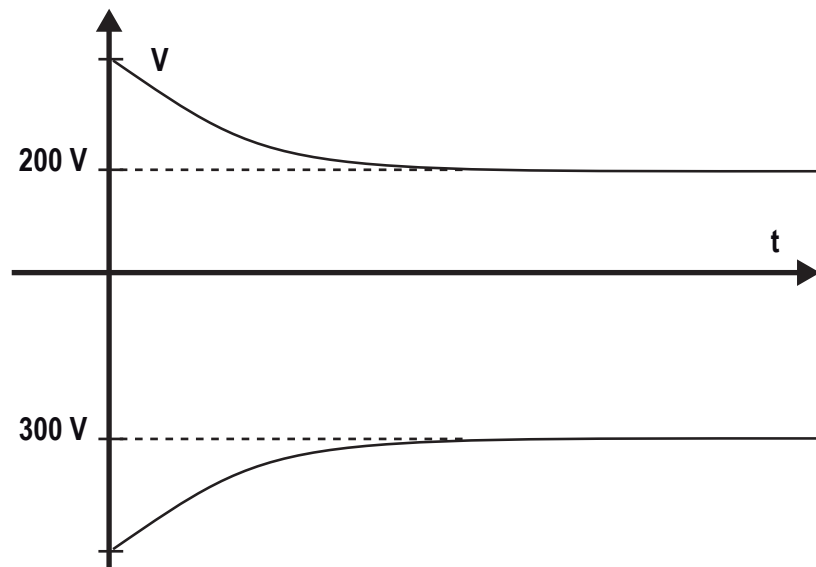

This means that if the system is made up of 10 modules in series and each one supplies 50V, the leakage can be located between the 4th and 5th PV module.

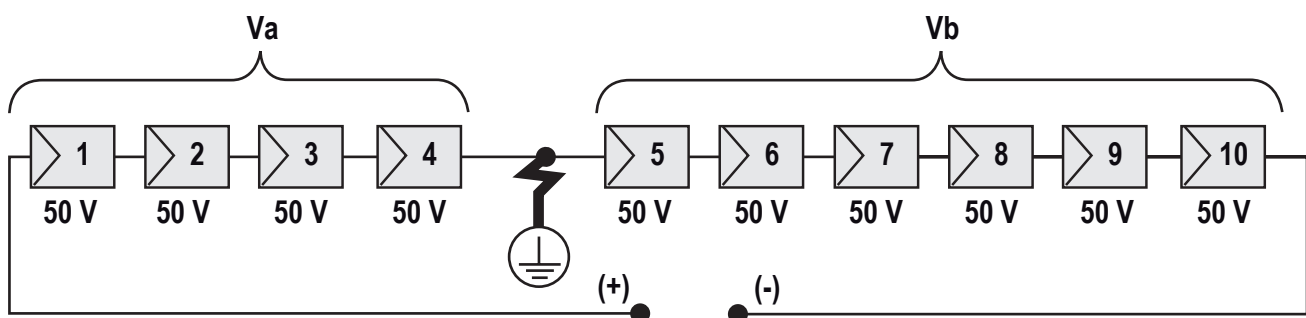

$V_a$  = voltage measured between + pole and  $\oplus$  = 200V

$V_b$  = voltage measured between - pole and  $\oplus$  = 300V

In all measurements with  $\oplus$ , the ground of the inverter is indicated.

## Measuring the insulation resistance of photovoltaic generator

To measure the insulation resistance of the PV generator compared to ground (⊕), the two poles of the PV generator must be short-circuited (using a suitably sized switch).

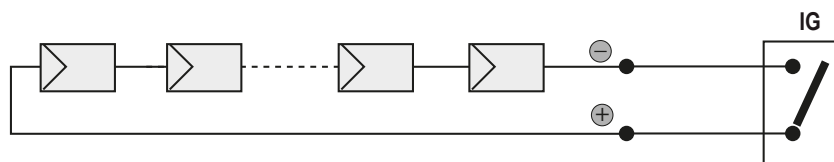

Once the short-circuit has been made, measure the insulation resistance (Riso) using a megohmmeter positioned between the two shorted poles and ground (of the inverter).

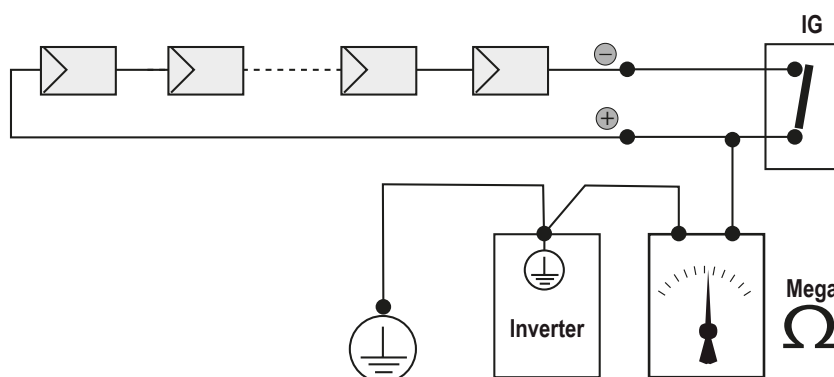

**-TL MODELS (transformerless).** If the measured insulation resistance (Riso) is less than 1Mohm the inverter does not connect to the grid due to a low insulation of photovoltaic generator respect to ground.

**-I MODELS (with high frequency transformer).** If the measured insulation resistance ( Riso in case of input poles floating respect to ground or QF=1 if the one of input poles is grounded) is less than 0.2Mohm the inverter does not connect to the grid due to a low insulation of photovoltaic generator respect to ground.

*The insulation resistance is affected by the environmental conditions the PV generator is in (E.g.: photovoltaic module wet from dump or rain), and therefore the measurement must be made immediately after the anomaly*

## Storage and dismantling

### Storage of the equipment or prolonged stop

If the equipment is not used immediately or is stored for long periods, check that it is correctly packed and contact **FIMER** for storage instructions. The equipment must be stored in well-ventilated indoor areas having no characteristics that could damage the components of the equipment.

Restarting after a long or prolonged stop requires a check and, in some cases, the removal of oxidation and dust that will also have settled inside the equipment if not suitably protected.

### Dismantling, decommissioning and disposal

FIMER is not responsible for any loss of the equipment, or part of it, which does not take place on the basis of the regulations and laws in force in the country of installation.

*The symbol of the cancelled bin (where present) indicates that the product must not be disposed of with domestic waste at the end of its useful life.*



*This product must be delivered to the waste collection point of the local community for recycling.*

*For further information, refer to the public body responsible for waste disposal in the country.*

Inappropriate disposal of waste can have a negative impact on the environment and human health owing to potentially dangerous substances.

By cooperating in the correct disposal of this product, you contribute to the reuse, recycling and recovery of the product, and the protection of our environment.

*Dispose of the various types of materials that the parts of the equipment consist of in dumps that are suitable for the purpose.*

COMPONENT	MATERIAL OF CONSTRUCTION
Frame, brackets, supports	Arc-welded steel FE37, aluminium
Casing or covers	ABS, plastic
Paint	Polyester Resin
Gaskets and seals	Rubber / Teflon / Viton
Electrical cables	Copper / Rubber
Cable trays	Polyethylene / Nylon
Batteries	Nickel / Lead/ Lithium

## Port and network services used by the inverter

### IP Network Services

Any network connected to the inverter must allow traffic to pass on the following ports. Network firewall rules (if present) must allow responses to the inverter over existing TCP connections.

Direction	Service/Port	Protocol	Description
In	ssh/22	Tcp	For local debugging by FIMER service personnel, the inverter utilizes encrypted SSH. To allow service personnel local access to the inverter.
Out	domain/53	Tcp/udp	The inverter must be able to resolve domain names, to ensure scalability and dynamic changes on the Internet (DNS). (required)
Out	https/443	Tcp	As an HTTP client, the inverter uses SSL/TLS protocol connections to Aurora Vision® servers for secure communication. The inverter uses this port for all services, including data transmission, firmware upgrade, configuration management, and remote command transmission. (required)
Out	dhcp/67, dhcp/68	Udp	If DHCP service is not available, static network information must be assigned to the inverter (preferred)
Out	ntp/123	Udp	The inverter uses this port for network time services (NTP). (preferred)
Out	modbus/502	Tcp	The inverter offer a Modbus TCP server connection on this port.
Out	dns-sd/5353	Udp	The inverter uses this protocol to resolve the local IP address.
Out	http/80	Tcp	As an HTTP client, the inverter uses this protocol to offer local connection.

## Network Hosts

The inverter will connect to the following hosts. Some servers owned by FIMER, and others are customer or ISP servers. Servers listed as owned by “Customer IT/ISP” must be configured in the inverter using either DHCP or as static network information.

Host	Purpose	Port	Owner/Manager
platform.auroravision.net	Data, configuration	TCP:443	FIMER
gw1.auroravision.net and/or apt.fatspaniel.net	Inverter firmware upgrade	TCP:443	FIMER
Site dependent	DHCP (optional)	UDP:67, UDP:68	Customer IT/ISP
Site dependent	DNS	UDP:53, TCP:53	Customer IT/ISP

## Inverter network configuration

The inverter requires a valid network configuration in order to operate. This information can either be provided by a DHCP server provided by the customers network (the default), or the inverter can be configured with static network information. Regardless of how the inverter is configured, the following information is required.

Configuration	Purpose
IP Address	Allows the inverter to take part in the local network. This does not need to be a public IP address. In most cases this is a private IP address.
Subnet mask	Used to determine if two computers are on the same network.
Gateway	The IP address of the computer which will forward network traffic from the local network to an external network
DNS Server	The IP address(es) of the computer(s) which resolve domain names.

## Contact us

[www.fimer.com](http://www.fimer.com)



For more information  
please contact  
your local FIMER  
representative or visit:

[fimer.com](http://fimer.com)

We reserve the right to make technical changes or modify the contents of this document without prior notice. With regard to purchase orders, the agreed particulars shall prevail. FIMER does not accept any responsibility whatsoever for potential errors or possible lack of information in this document.

We reserve all rights in this document and in the subject matter and illustrations contained therein. Any reproduction, disclosure to third parties or utilization of its contents – in whole or in parts – is forbidden without prior written consent of FIMER. Copyright© 2020 FIMER. All rights reserved.