



Product Manual

# **UNO-DM-6.0-TL-PLUS- US-Q (6.0 kW)**

## IMPORTANT SAFETY INSTRUCTIONS



*This manual contains important safety instructions that must be followed during the installation and maintenance of the equipment.*

## SAVE THESE INSTRUCTIONS!



*Keep this document in a safe place near the inverter for easy access during installation, operation and maintenance.*

## THE INSTALLER MUST READ THIS DOCUMENT IN ITS ENTIRETY BEFORE INSTALLING THIS EQUIPMENT.

*Operators are required to read this manual and scrupulously follow the instructions given in it, since ABB cannot be held responsible for damage caused to people and/or things, or the equipment, if the conditions described below are not observed.*

*The purpose of this document is to support the qualified technician, who has received training and/or has demonstrated skills and knowledge in construction, to install, operate and maintain the inverter. This manual covers only inverter, not any equipment (photovoltaic modules, external disconnects, etc) to which it is connected.*

*Warranty requirements are included in the Terms and Conditions of sale included with the inverter order.*

*NOTE: Any changes made to the product or to the installation conditions that hasn't been approved by ABB will void the warranty.*



*All pictures and illustrations shown in this user manual are indicatives and must be intended as support for installation instruction only. Actual product may vary due to product enhancement. Specifications subject to change without notice. The latest version of this document is available on the ABB website.*

## FCC REMARKS

*The equipment has been tested and found to comply with the limits for a Class B digital device, pursuant to Part 15 of the FCC Rules. These limits are designed to provide reasonable protection against harmful interference in a residential installation. This equipment generates, uses and can radiate radio frequency energy and, if not installed and used in accordance with the instructions, may cause harmful interference to radio communications.*

*However, there is no guarantee that interference will not occur in a particular installation. If this equipment does cause harmful interference to radio or television reception, which can be determined by turning the equipment off and on, the user is encouraged to try to correct the interference by one or more of the following measures:*

- Reorient or relocate the receiving antenna.*
- Increase the separation between the equipment and receiver.*
- Connect the equipment into an outlet on a circuit different from that to which the receiver is connected.*
- Consult the dealer or an experienced radio/TV technician for help.*



*The products are designed to be connected to and to communicate information and data via a network interface. It is the user's sole responsibility to provide and continuously ensure a secure connection between the product and the user's network or any other network (as the case may be). The user shall establish and maintain any appropriate measures (such as but not limited to the installation of firewalls, application of authentication measures, encryption of data, installation of anti-virus programs, etc) to protect the product, the network, its system and the interface against any kind of security breaches, unauthorized access, interference, intrusion, leakage and/or theft of data or information. ABB and its affiliates are not liable for damages and/or losses related to such security breaches, any unauthorized access, interference, intrusion, leakage and/or theft of data or information. The data, examples and diagrams in this manual are included solely for the concept or product description and are not to be deemed as a statement of guaranteed properties. All persons responsible for applying the equipment addressed in this manual must satisfy themselves that each intended application is suitable and acceptable, including that any applicable safety or other operational requirements are complied with. In particular, any risks in applications where a system failure and/or product failure would create a risk for harm to property or persons (including but not limited to personal injuries or death) shall be the sole responsibility of the person or entity applying the equipment, and those so responsible are hereby requested to ensure that all measures are taken to exclude or mitigate such risks. This document has been carefully checked by ABB but deviations cannot be completely ruled out. In case any errors are detected, the reader is kindly requested to notify the manufacturer. Other than under explicit contractual commitments, in no event shall ABB be responsible or liable for any loss or damage resulting from the use of this manual or the application of the equipment.*

## **Product manual**

### **UNO-DM-6.0-TL-PLUS-US-QU**

#### **1 - Safety and accident prevention**

#### **2 - Introduction and general information**

#### **3 - Characteristics**

#### **4 - Lifting and transport**

#### **5 - Installation**

#### **6 - Instruments**

#### **7 - Operation**

#### **8 - Maintenance**

#### **9 - Attachments**

# Table of Contents

Table of Contents.....	5
<b>Safety and accident prevention .....</b>	<b>9</b>
<b>Safety information and instructions .....</b>	<b>9</b>
<b>Symbols and signs.....</b>	<b>10</b>
<b>Installation and maintenance safety .....</b>	<b>11</b>
General safety information.....	11
Environmental conditions and risks .....	11
Electrical and thermal safety.....	12
Clothing and protection of personnel.....	13
<b>Residual risks .....</b>	<b>14</b>
Table of residual risks .....	14
<b>Introduction and general information.....</b>	<b>15</b>
<b>Warranty and supply conditions.....</b>	<b>15</b>
Not included in the supply.....	15
<b>Scope and target audience.....</b>	<b>16</b>
Purpose and document structure .....	16
List of appendix documents .....	16
Operator and maintenance personnel skills/prerequisites .....	16
<b>Application area, general conditions .....</b>	<b>17</b>
Intended or allowed use.....	17
Limits in field of use.....	17
Improper or prohibited use .....	17
<b>Characteristics .....</b>	<b>18</b>
<b>General conditions .....</b>	<b>18</b>
<b>Models and range of equipment.....</b>	<b>19</b>
Identification of the equipment and manufacturer .....	20
<b>Reference number index .....</b>	<b>22</b>
<b>Graphical representation of references .....</b>	<b>22</b>
<b>Accessory Board UNO-DM-COM KIT (optional).....</b>	<b>23</b>
<b>Accessory Board UNO-DM-PLUS-Ethernet COM KIT (optional).....</b>	<b>23</b>
<b>Technical data .....</b>	<b>24</b>
Response to abnormal conditions .....	26
Grid support function.....	27
Torques .....	29
Outer dimensions.....	29
Bracket dimensions.....	30
<b>Efficiency curves .....</b>	<b>31</b>
<b>Power limitation (Power Derating).....</b>	<b>32</b>
Power reduction due to environmental conditions.....	32
Power reduction due to the input voltage .....	33
<b>Characteristics of a photovoltaic generator.....</b>	<b>34</b>
Strings and arrays.....	34

<b>Description of the inverter</b> .....	<b>35</b>
Multiple-inverter system .....	35
Notes on system sizing .....	35
Inverter block diagram .....	35
PV plant block diagram .....	37
Operating diagram .....	37
Default functionality and components of the inverter .....	38
Functionalities available with accessory board .....	39
<b>Safety devices</b> .....	<b>41</b>
Anti-Islanding .....	41
Photovoltaic panel ground fault .....	41
Arc Fault Detection (AFD).....	41
Ground fault detection and interruption scheme .....	41
Other safeguards .....	42
<b>Lifting and transport</b> .....	<b>43</b>
Transport and handling .....	43
Lifting.....	43
Unpacking and incoming inspection .....	43
Storage.....	44
Weights .....	44
Lifting.....	44
Packing list.....	45
<b>Installation</b> .....	<b>46</b>
<b>Installation warnings</b> .....	<b>46</b>
Installation site and position.....	47
Installation sites with high humidity .....	48
Wireless signal environmental checks.....	49
Recommendations for the wireless signal power .....	51
<b>Wall mounting</b> .....	<b>52</b>
<b>Opening the front cover</b> .....	<b>53</b>
<b>Installation planning</b> .....	<b>54</b>
AC overcurrent protection .....	54
Choice of grid output connection type (AC side) .....	54
Sizing the ground cable(s).....	55
Sizing the AC cable.....	55
Clamps terminal use .....	56
<b>Preliminary operations for connection of the PV generator</b> .....	<b>57</b>
Independent or parallel input channels configuration.....	57
Channel configuration examples .....	58
Independent channel configuration (default configuration) .....	59
Parallel channel configuration .....	59
Checking the correct polarity of the strings .....	60
Checking of leakage to ground of the photovoltaic generator.....	60
<b>Electrical connection to the PV field - DC side</b> .....	<b>61</b>
<b>Grid output connection (AC side)</b> .....	<b>63</b>
Connection to AC terminal block.....	63
Grid standard setting of the country.....	64
<b>Rapid Shutdown (RSD) connection</b> .....	<b>65</b>

<b>Communication and control signal connections to the accessory UNO-DM-COM KIT board ...</b>	<b>66</b>
Description of terminal blocks on the UNO-DM-COM KIT board .....	67
Description of terminal blocks on the UNO-DM-PLUS-Ethernet COM KIT board .....	68
Connection of the RS485 line .....	69
Remote control connection .....	71
Demand Responce Mode 0 (Request by AS/NZS 4777).....	71
Configurable Relay connection (ALARM / LOAD MANAGER) .....	72
<b>Closing the front cover .....</b>	<b>73</b>
<b>Instruments.....</b>	<b>74</b>
Description LED Panel.....	75
<b>Operation .....</b>	<b>76</b>
<b>Introduction and operation warnings .....</b>	<b>76</b>
<b>Monitoring and data transmission .....</b>	<b>77</b>
User interface .....	77
Measurement tolerance .....	77
<b>Commissioning (Via internal Webserver).....</b>	<b>78</b>
<b>Power, Alarm, GFI LEDs behavior .....</b>	<b>86</b>
<b>COMM, WLAN LEDs behavior.....</b>	<b>87</b>
<b>Description of the internal Webserver .....</b>	<b>88</b>
Access to the internal Webserver .....	88
webserver menu structure .....	91
MAIN section.....	92
SETTING section .....	93
Inverter Log Section.....	97
USER section.....	98
CONNECTIVITY section.....	99
SERVICE TOOLS section.....	103
Information .....	106
<b>Maintenance .....</b>	<b>107</b>
<b>General conditions .....</b>	<b>107</b>
<b>Inverter total de-energization and safe access .....</b>	<b>108</b>
Operator and maintenance personnel skills/prerequisites .....	108
Clothing and protection of personnel.....	109
Safety equipment and tools .....	109
Inverter total de-energization and safe access procedure .....	110
<b>Routine maintenance .....</b>	<b>118</b>
<b>Troubleshooting .....</b>	<b>119</b>
Internal Web user interface and wireless communication troubleshooting.....	119
Alarm Messages of the Inverter.....	121
Power limitation messages .....	128
<b>Dismantling the inverter .....</b>	<b>129</b>
<b>Calculation of second-level password (Service menu, Admin Plus) .....</b>	<b>130</b>
<b>Replacement of the MEMORY board.....</b>	<b>131</b>
<b>Replacement of the buffer battery.....</b>	<b>132</b>
<b>Verification of ground leakage .....</b>	<b>133</b>
Behavior of a system without leakage .....	133
Behavior of a system with leakage .....	134
<b>Measuring the insulation resistance of the PV generator. ....</b>	<b>135</b>

<b>Storage and dismantling .....</b>	<b>136</b>
Storage of an uninstalled inverter for long periods.....	136
Storage of an installed inverter for long periods of non-use.....	136
Disposal.....	136
<b><i>Attachments</i> .....</b>	<b>137</b>
<b>Port and network services used by the inverter.....</b>	<b>137</b>
IP Network Services.....	137
Network Hosts.....	138
Inverter network configuration .....	138
<b>Further information .....</b>	<b>139</b>
<b>Contact us .....</b>	<b>140</b>



## ***Safety and accident prevention***

# 1

### **Safety information and instructions**

This chapter contains the safety instructions which you must obey when you install and operate the inverter and perform maintenance operations on the inverter. Obey these safety instructions to prevent injury or death, or damage to the equipment.

The instructions provided in the manual do not replace the safety devices and technical data for installation and operation labels on the product, and they do not replace the safety regulations in force in the country of installation.











The operators must read and comply with the technical information and instruction provided in the manual and in the attached documentation.

FIMER accepts no liability for failure to comply with the instructions for correct installation and cannot be held responsible for the upstream or downstream equipment.

Specific safety information are provided during installation, commissioning and maintenance operation instructions. Always follow the reading order of instruction exactly as described in this manual.

## Symbols and signs

In the manual and/or in some cases on the equipment, the danger are indicated with signs, labels, symbols or icons.

Symbol	Description
	<b>General warning</b> - Important safety information. Indicates a potentially hazardous situation which, if not avoided, could result in death or serious injury.
	<b>Dangerous Voltage</b> - Indicates a potentially hazardous situation, in particular a high voltage, which, if not avoided, could result in death or serious injury. The inverter has high voltages and energy levels.
	<b>Hot parts</b> - Indicates a potentially hazardous situation, in particular a hot surface, which, if not avoided, could result in death or serious injury. Some surfaces in the inverter will become hot during operation and must not be touched until the parts have cooled down.
	Risk of injury due to the weight of the equipment. Take care during lifting and transport
	Ground connection point.
	Rated temperature range.
	Direct current.
	Alternating current.
	The DC input voltage positive terminal.
	The DC input voltage negative terminal.

## Installation and maintenance safety

### General safety information



*Do not proceed with installation if the integrity of the equipment is compromised. Do not use the equipment if you find any operating anomalies.*



*Avoid temporary repairs. All repairs should be carried out using only genuine spare parts, which must be installed in accordance with their intended use.*



*The labels affixed on the equipment must strictly NOT be removed, damaged, defaced, hidden, etc. The technical data provided in this manual does not in any case replace that shown on the labels affixed on the equipment*

*Do not do work on the photovoltaic generator, or the inverter, or its input or output cables, when the inverter is connected to an electrical power system, or to the photovoltaic generator.*

*Before performing any maintenance operation on the inverter, follow this steps:*



- **Prepare the work: Do an on-site Risk Assessment or Job Hazard Analysis** (Check for proper tools and PPE for the Job; Engage the person responsible for electrical equipment or system to review single-line, schematics, switching plans; Decide on the appropriate work methods and initiate the permit to work process).
- **Clearly identify the work location and equipment.**
- **Disconnect all sources and Secure against reconnection by means of a 'Lockout/Tagout' procedure to ensure it cannot accidentally become live.**
- **Verify the absence of operating voltage** (This must be by means of a proper test instrument).
- **Complete the permit to work and "Walk the Permit"** (Now we have verified a 'safe working area' it is time to validate the 'Permit to Work' and "Walk the Permit").

**Refer to "Inverter total de-energization and safe access" chapter on this manual to know all detailed necessary steps to safely operate on the inverter.**

### Environmental conditions and risks



*The device can be installed outdoors, but only in environmental conditions that do not prevent its regular operation. These conditions are listed in the technical data and in the installation chapter.*



*Do not open the front covers of the inverter when it is raining, or when sand or dust can blow into the unit. Water or sand in the inverter can cause damage in the unit. In the risk assessment prior any intervention on the equipment it is of paramount importance to evaluate the weather conditions. Any intervention on the inverter can be done only in case of dry environment. Don't proceed in case of rain (even light) or high humidity.*



*The device is not designed to operate in environments that are particularly inflammable or explosive.*



*In the event of fire, use CO2 extinguishers and auto-extraction systems to extinguish the fire in closed environments.*



*The installer or maintenance technician must always pay attention to the work environment, ensuring that it is well-lit and there is enough room to ensure an escape route.*

## Electrical and thermal safety



**WARNING!** Obey these instructions to prevent injury or death, or damage to the equipment. If you are not a qualified electrician, do not perform any electrical installation or maintenance work.



Obey all installation safety standards. This can require, among other things, the use of personal protection equipment (PPE), such as arc-proof clothing, arc-proof masks, protective footwear, insulating and protective gloves, eye protection and hearing protection. High power inverter installations have high fault currents.



Before you operate on the inverter, isolate the AC line cables from the electrical power system with the AC disconnect switch of the power system transformer (downstream the inverter). Also, isolate the inverter from the photovoltaic generator with the DC disconnect switch of the generator or by other means (upstream the inverter). The internal AC disconnect switch (if present) do not isolate the AC output cables and terminals of the inverter from the electrical power system. The internal DC disconnect switches (if present) do not completely isolate the DC input cables or terminals from the DC voltage supplied by the photovoltaic generator. **Refer to “Inverter total de-energization and safe access” chapter on this manual for further details.**



Do not work on the communication and control signal cables when power is applied to the inverter or to the external control circuits.



Do not perform insulation or voltage withstand tests on the inverter.



FIMER inverters must be earthed via the connection points marked with the protective earth symbol ⊕ and using a cable with an appropriate conductor cross-section for the maximum ground fault current that the generating system might experience.



Do not switch-on the inverter with the front covers open, even during troubleshooting. The inverter front covers act as arc hazard protection. If a highly unlikely arc flash incident occurs when the inverter front covers are open, the arc-flash proof protection equipment might not provide sufficient protection for the operators.



When the device has just been switched off, it may have hot parts as a result of overheating of the heated surfaces (e.g.: transformers, accumulators, coils, etc.) so be careful where you touch.

## Clothing and protection of personnel

NFPA standards (which OSHA recommends and consults) require the equipment owner to field-label electrical equipment with labels containing the available incident energy and required level of PPE, to protect both in-house and contract workers from electric shock and arc flash.

Label requirements are determined by site-specific arc flash studies and depend on the inverter model, types and exact locations of external disconnects upstream and downstream of the inverter, by voltages and power levels at any given installation.

NFPA 70E Article 130.3 states that the analysis must be reviewed at least every 5 years or whenever a major modification occurs. This means that the label should include a date, and the date must be documented.

The system is not ready for commissioning until PPE labels have been installed.



Personnel must not wear clothes or accessories that could start fires or generate electrostatic charges or, in general, clothing that can compromise personal safety.

## Residual risks



Despite the warnings and safety systems, there are still some residual risks that cannot be eliminated.

These risks are listed in the following table with some suggestions to prevent them.

**Table of residual risks**

RISK ANALYSIS AND DESCRIPTION	SUGGESTED REMEDY
Noise pollution due to installation in unsuitable environments or where individuals routinely work and/or animals dwell most of the time.	Reassess the environment or the place of installation.
Suitable local ventilation that does not cause overheating of the equipment and is sufficient not to create discomfort to people in the room.	Restore suitable ambient conditions and air the room.
External weather conditions, water seepage, low temperatures, high humidity, etc.	Maintain ambient conditions suitable for the system.
Overheating of surfaces at temperature (transformers, coils, etc. ) can cause burns.	Use suitable PPE. Wait for the parts to cool down before opening the inverter. Do not restrict cooling openings or heatsinks.
Inadequate cleaning compromises cooling and does not allow the safety labels to be read.	Clean the equipment, labels and work environment
Accumulation of electrostatic energy can generate hazardous discharges.	Ensure components have discharged their energy before working on them.
Inadequate training of staff.	Ask for a supplementary course.
During installation, temporarily mounting the equipment or its components may be risky.	Prevent unauthorized access to the installation area. Use sufficient people and PPE.
Accidental disconnections of the quick-fit connectors with the equipment in operation, or wrong connections, may generate electric arcs	Prevent unauthorized access to the installation area and lock out/tag out the inverter before working on it.
Use the same brand for the counterparts of the quick-fit connectors installed on the inverter	Mismatched connectors may void the warranty and cause potential damage

### Warranty and supply conditions

The warranty conditions (available on the official FIMER website) are considered to be valid if the Customer adheres to the indications in this manual; any condition deviating from those described herein must be expressly agreed in the purchase order.

*FIMER declares that the equipment complies with the provisions of law currently in force in the country of installation and has issued the corresponding declaration of conformity.*

#### Not included in the supply

*FIMER accepts no liability for failure to comply with the instructions for correct installation and will not be held responsible for systems upstream or downstream of the equipment it has supplied.*



*It is absolutely forbidden to modify the equipment. Any modification, manipulation, or alteration not expressly agreed with the manufacturer, concerning either hardware or software, shall result in the immediate cancellation of the warranty.*

*The customer is fully responsible for any changes made to the system.*

Given the countless array of system configurations and installation environments possible, it is essential to check the following: adequate spaces, suitable for housing the equipment; airborne noise produced based on the environment; possible flammability conditions.

FIMER will NOT be held liable for defects or malfunctions arising from: improper use of the equipment; deterioration resulting from transportation or particular environmental conditions; performing maintenance incorrectly or not at all; tampering or unsafe repairs; use or installation by unqualified persons.

FIMER is not responsible for any loss of the equipment, or part of it, which does not take place on the basis of the regulations and laws in force in the country of installation.

# Scope and target audience

## Purpose and document structure

This operating and maintenance manual is a useful guide that will enable you to work safely and carry out the operations necessary for keeping the equipment in good working order.



*If the equipment is used in a manner not specified in this manual, the protections and the certifications provided by the equipment may be impaired with the consequent loss of warranty.*



*The language in which the document was originally written is ENGLISH; therefore, in the event of inconsistencies or doubts please ask the manufacturer for the original document.*

## List of appendix documents

In addition to this user manual and maintenance you can consult (and download) the product documentation by visiting <https://www.fimer.com>.



*Part of the information given in this document is taken from the original supplier documents. This document contains only the information considered necessary for the use and routine maintenance of the equipment.*

## Operator and maintenance personnel skills/prerequisites



*Personnel in charge of using and maintaining the equipment must be skilled for the described tasks and must reliably demonstrate their capacity to correctly interpret what is described in the manual.*



*For safety reasons, the installation must be performed by qualified installers and/or licensed electricians in accordance with the existing regulations in the country of installation and in accordance to all safety rules for performing electrical works. The installers must have demonstrated skills and knowledge of the inverter's structure and operation.*



*Inverter operation and maintenance by a person who is NOT qualified, is intoxicated, or on narcotics, is strictly forbidden.*



*The customer has civil liability for the qualification and mental or physical state of the personnel who interact with the equipment. They must always use the personal protective equipment (PPE) required by the laws of the country of destination and whatever is provided by their employer.*



## Application area, general conditions

FIMER shall not be liable for any damages whatsoever that may result from incorrect or careless operations.



*You may not use the equipment for a use that does not conform to that provided for in the field of use. The equipment **MUST NOT** be used by inexperienced staff, or even experienced staff if carrying out operations on the equipment that fail to comply with the indications in this manual and enclosed documentation.*

### Intended or allowed use

This equipment is a inverter designed for:  
transforming a continuous electrical current (DC)  
supplied by a photovoltaic generator (PV)  
in an alternating electrical current (AC)  
suitable for feeding into the public distribution grid.

### Limits in field of use

---

*The inverter can be used only with photovoltaic modules which have ground isolated input poles.*

---

*Only a photovoltaic generator can be connected in the input of the inverter (do not connect batteries or other sources of power supply).*

---

*The inverter can be connected to the electricity grid only in countries for which it has been certified/approved.*

---

*The inverter cannot be connected to the DC side in parallel to other inverters.*

---

*The inverter may only be used in compliance with all its technical characteristics.*

---

### Improper or prohibited use

*IT IS STRICTLY FORBIDDEN TO:*



- Install the equipment in environments subject to particular conditions of flammability or in adverse or disallowed environmental conditions, (temperature and humidity).*
- Use the equipment with safety devices which are faulty or disabled.*
- Use the equipment or parts of the equipment by linking it to other machines or equipment, unless expressly provided for.*
- Modify operating parameters that are not accessible to the operator and/or parts of the equipment to vary its performance or change its isolation.*
- Clean with corrosive products that could corrode parts of the equipment or generate electrostatic charges.*
- Use or install the appliance or parts of it without having read and understood the contents of the user and maintenance manual.*
- Placing any heavy object, sit or stand up on the inverter.*
- Heat or dry rags and clothing on the parts in temperature. In addition to being hazardous, doing so would compromise component ventilation and cooling.*



## Characteristics

# 3

### General conditions

A description of the equipment characteristics is provided to identify its main components and specify the technical terminology used in the manual.

This chapter contains information about the models, details of the equipment, characteristics and technical data, overall dimensions and equipment identification.



*The customer/Installer takes full responsibility if, when reading this manual, the chronological order of its presentation provided is not observed. All information is provided considering occasional inclusion of information in previous chapters.*



In certain cases, there may be a need to separately document software functionality or attach supplementary documentation to this manual which is intended for more qualified professionals.

## Models and range of equipment

For each model, the following variant is available:

- **Model with “SB-RA” suffix (e.g. UNO-DM-6.0-TL-PLUS-US-SB-RA-QU).**

Meaning of the suffix SB-RA:

S = DC disconnecting switch .

B = Wireless communication

R = Rapid shutdown

A = ARC fault device

U = Unbalanced input channels



*The choice of the inverter model must be made by a qualified technician who knows about the installation conditions, the devices that will be installed outside the inverter and possible integration with an existing system.*

## Identification of the equipment and manufacturer

The technical data provided in this manual does not substitute the data supplied on the labels affixed to the equipment.



The labels affixed to the equipment must NOT be removed, damaged, stained, hidden, etc., for any reason whatsoever.

The Regulatory label contains the following information:

1. **Manufacturer**
2. **Model**
3. **Rating data**
4. **Certification marks**
5. **Inverter Part Number**
6. **Week/Year of manufacture**
7. **Inverter Serial Number consisting of:**
  - YY = Year of manufacture
  - WW = Week of manufacture
  - SSSSSS = sequential number

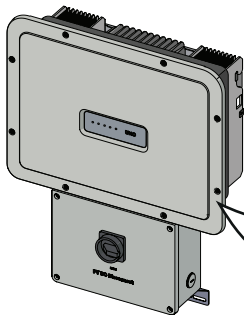

**1** **ABB**

**4**

SOLAR GRID SUPPORT UTILITY INTERACTIVE TRANSFORMERLESS INVERTER  
 MODEL: UNO-D **2** -TL-PLUS-US-Q Country of Origin: Italy

AC RATING	
Rated Grid AC Voltage (Vacr)	
Operating Voltage Range	
Nominal Output Frequency	
Operating Frequency Range	
Power Factor	
Nameplate Apparent Power (Smax)	
Nameplate Active Power (Pmax @cos φ=1)	
Rated Active Power (@Vacr, cos φ= ± 0.9)	
cosφ Adjustability Range	
Max. Output Current	
Max. Output Overcurrent Protection	

DC RATING	
Nominal Input Operating Voltage	
Max. Input Voltage	
Range of Input Operating Voltage	
Range of Input Voltage @Full Power	
Max. Input Current - per channel	
Max. Input Short Circuit Current - per channel	

Operating Ambient Temperature: -25 to +60 °C (-13 to +140 °F) with Output Power Derating  
 Type of Enclosure: NEMA 4X  
 DC Ground Fault Detector/Interrupter is Provided Photovoltaic Arc-Fault Circuit Protection Type 1  
 (†): Adjustable from 50.0 Hz to 59.9 Hz (‡): Adjustable from 60.1 Hz to 64.0 Hz  
 (‡): Adjustable from -0.8 to +0.8 @Smax  
 For more details about product specifications refer to the Instruction Manual

Contains FCC ID: X6W-V2P53  
 This device complies with Part 15 of the FCC Rules. Operation is subject to the following two conditions: (1) this device may not cause harmful interference, and (2) this device must accept any interference received, including interference that may cause undesired operation

PN: P P P P P P P P P P

**5**

SO: S X X X X X X X X X  
Q X X

WO: X X X X X X X X X X

**6**

SN: Y Y W W S S S S S S

**7**

Power-One Italy S.p.A.  
Via San Giorgio 642, Terranuova Bracciolini (AR), 52028, Italia

An additional Wireless Identification label is provided.  
The label displays the following information:

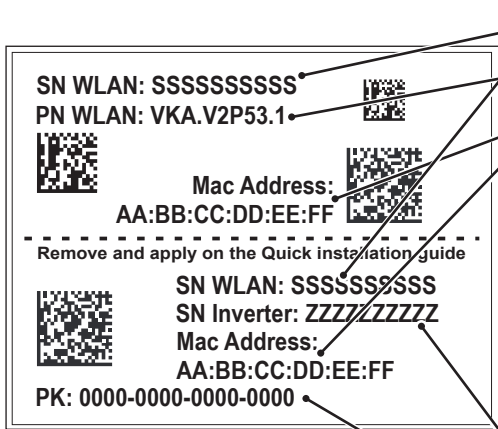

The diagram shows a rectangular label divided into two sections by a dashed line. The top section contains the following information: SN WLAN: SSSSSSSSSS, PN WLAN: VKA.V2P53.1, Mac Address: AA:BB:CC:DD:EE:FF, and a QR code. The bottom section contains: SN WLAN: SSSSSSSSSS, SN Inverter: ZZZZZZZZZZ, Mac Address: AA:BB:CC:DD:EE:FF, and PK: 0000-0000-0000-0000. A dashed line separates the two sections with the text 'Remove and apply on the Quick installation guide' below it. Callout lines point from the label to the following text:

- **WLAN board Serial Number**
- **WLAN Board Part Number**
- **WLAN Board MAC address:**
  - To be used to obtain the SSID of the wireless access point created by the inverter: **ABB-XX-XX-XX-XX-XX-XX** (where “X” is a hex digit of the MAC address).
  - To be used to obtain the “Host Name”:  
**http://ABB-XX-XX-XX-XX-XX-XX.local** (where “X” is a hex digit of the MAC address).
  - MAC address it’s the only required information to register the inverter with Aurora Vision.
- **Inverter Serial Number**
- **Product Key:**
  - To be used as wireless access point password, after 24 hours which the inverter is power on (then the default password “FIM-ERSOLAR” is expired) or to be used to access to the internal webserver as username and password in case of lost credentials.



*The Wireless Identification label is divided in two separate parts by a dashed line; take the bottom part and apply it on the cover page of the quick installation guide.*



*The officially required information is located on the Regulatory label. The product label or the Wireless Identification label are accessory labels which shows the information necessary for the identification and characterisation of the inverter by FIMER.*



*Note: The labels are NOT to be hidden by foreign objects and parts (rags, boxes, equipment, etc.); they must be regularly cleaned and always kept in sight.*

## Reference number index

- |                              |  |  |
|------------------------------|--|--|
| 01, Bracket                  | 11, Wireless antenna                               | 18, Accessory boards                       |
| 03, Heat sink                | 12, DC Input terminal block                        | 19, Protective Earth (PE) connection point |
| 04, Inverter front cover     | 13, 3/4" DC conduit opening (1" drill out marking) | 20, Inverter                               |
| 05, Wiring box front cover   | 14, 3/4" AC conduit opening                        | 28, Wiring box                             |
| 06, LED panel                | 15, 1/2" signal conduit drill out marking          | 29, Lower bracket                          |
| 09, RSD terminal block       | 16, DC disconnect switch                           |  |
| 10, AC output terminal block |  |  |

## Graphical representation of references

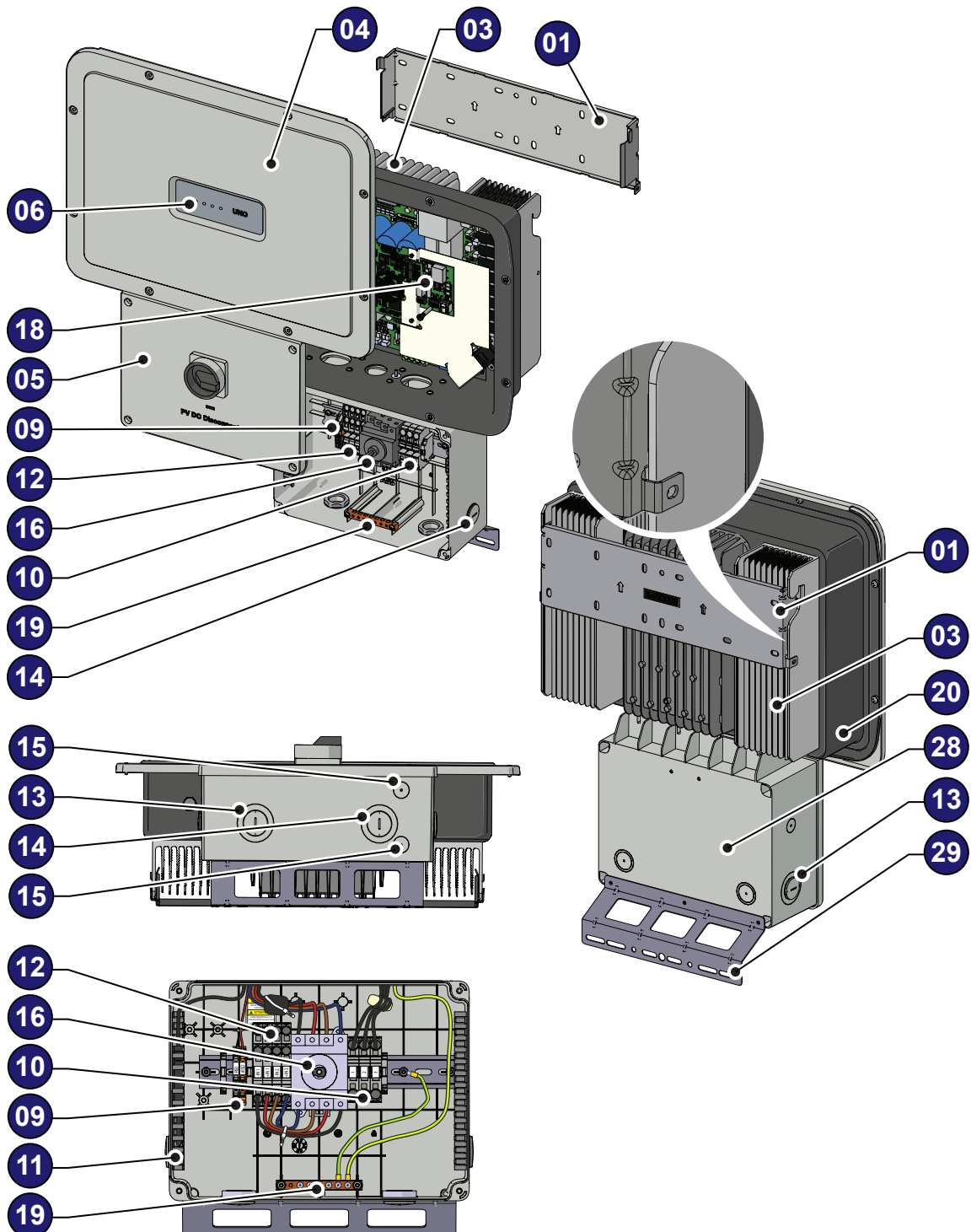

## Accessory Board UNO-DM-COM KIT (optional)

The inverter can be equipped with advanced accessory board PN: UNO-DM-COM Kit (ordered separately), adding:

- An RS-485 serial interface
- Configurable relay:
- Remote switch-on/switch-off

- 18, UNO-DM-COM KIT
- 21, Inverter connector
- 22, RS485 Termination line jumper
- 23, DRM0 activation jumper
- 24, ALARM terminal block
- 25, Fixing point
- 26, RS485 and REM terminal block

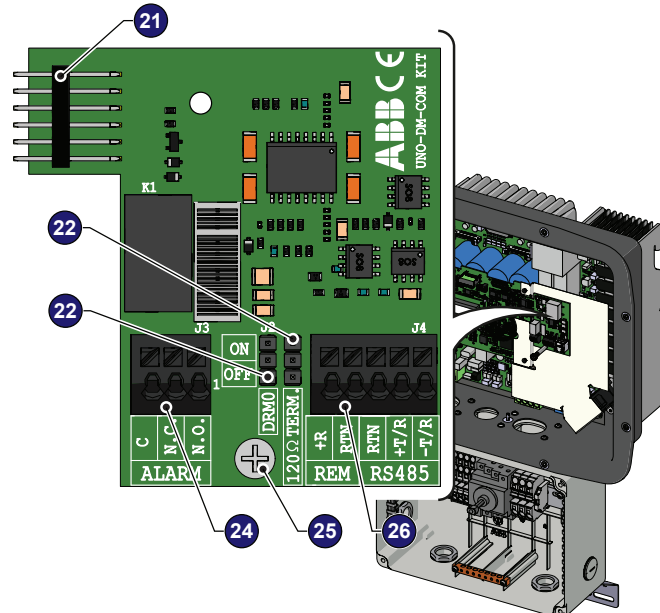

## Accessory Board UNO-DM-PLUS-Ethernet COM KIT (optional)

The inverter can be equipped with advanced accessory board PN: UNO-DM-PLUS-Ethernet COM KIT (ordered separately), adding:

- An RS-485 serial interface and the Ethernet communication interface
- Configurable relay:
- Remote switch-on/switch-off

- 18, UNO-DM-PLUS-Ethernet COM KIT
- 21, Inverter connector
- 22, RS485 Termination line jumper
- 23, DRM0 activation jumper
- 24, ALARM terminal block
- 25, Fixing point
- 26, RS485 and REM terminal block
- 27, LAN Ethernet connector

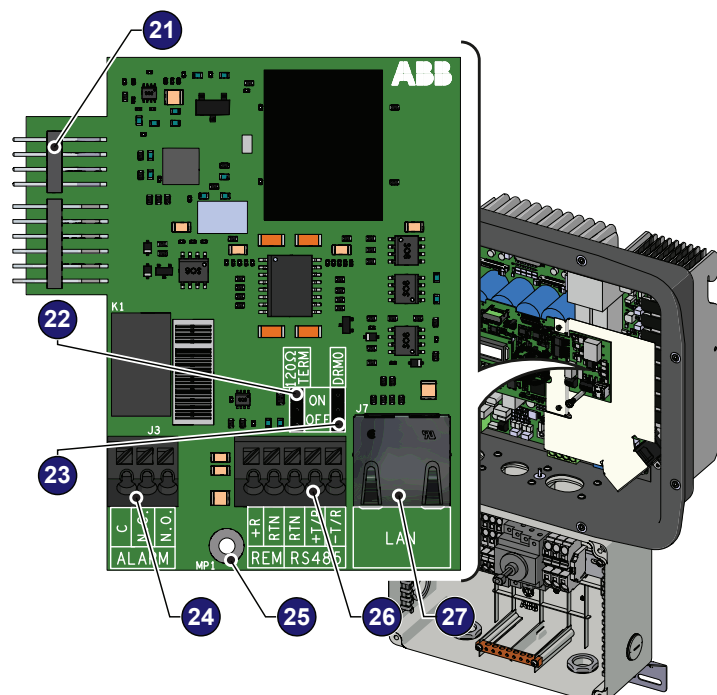

## Technical data

### UNO-DM-6.0-PLUS-US-QU

Input side (DC)	
Absolute maximum voltage ( $V_{\max,abs}$ )	600 V
Start-up voltage ( $V_{\text{start}}$ )	default 200 V (120...350 V)
Operating MPPT voltage range ( $V_{\text{dcmin}} \dots V_{\text{dcmax}}$ )	0.7x $V_{\text{start}}$ ...580 V ( $\geq 90V$ )
Maximum usable power ( $P_{\text{dcrMPPT}}$ ) - each channel	4000 W
Number of independent MPPT channels	2
Full power MPPT voltage range ( $V_{\text{MPPT min}} \dots V_{\text{MPPT max}}$ ) with parallel MPPT configuration a $P_{\text{acr}}$	200...480 V
Maximum usable current ( $I_{\text{dc max}}$ ) per channel	20.0 A (CH1)-11.5 A (CH2)
Maximum current ( $I_{\text{dc max}}$ )	31.5 A
Maximum short circuit current ( $I_{\text{sc max}}$ ) per channel	24 A
Number of wire landing terminals	2 pairs, capable of connecting two parallel strings
Array wiring termination	Terminal block, pressure clamp, AWG20-8
Input protection	
Reverse Polarity Protection	Yes, from current limited source
Over-voltage protection type	Varistor
PV array ground fault detection	Pre start-up RISO and dynamic GFDI
DC switch rating	32A@600V
Output side (AC)	
AC grid connection type	1 $\Phi$ /2W or Split- $\Phi$ /3W
Nameplate Apparent Power ( $S_{\max}$ )	6650 VA (208 Vac) 6650 VA (240 Vac)
Nameplate Output Active Power ( $P_{\max@\cos\phi=1}$ )	6000 W (208 Vac) 6000 W (240 Vac)
Output Active Power @ $V_{\text{acr}}$ and $\cos\phi=\pm 0,9$ ( $P_{\text{Rated}}$ )	6000 W (208 Vac) 6000 W (240 Vac)
Nominal AC output voltage ( $V_{\text{acr}}$ )	208Vac (1 $\Phi$ /2W) or 240Vac (Split- $\Phi$ /3W)
Adjustable voltage range ( $V_{\text{acmin}} \dots V_{\text{acmax}}$ )	183...228 Vac (1 $\Phi$ /2W) or 211...264 Vac (Split- $\Phi$ /3W)
Maximum current ( $I_{\text{ac max}}$ )	30 A
Contributory fault current	40.0 Arms, 100 ms
Grid frequency ( $f_r$ )	60 Hz
Adjustable grid frequency range ( $f_{\text{min}} \dots f_{\text{max}}$ )	50...64 Hz
Power factor and adjustability range	>0.995, adj. +/-0.8
Total harmonic distortion at rated power	<2%
Grid wiring termination type	Terminal block, pressure clamp, AWG20-6
Output Protection	
Anti-islanding protection	Meets UL1741 / IEEE1547 requirements
Over-voltage protection type	Varistor, 2 (L1 - L2 / L1 - G)
Maximum AC OCPD rating	40.0 A
Operating Performance	
Maximum efficiency ( $\eta_{\max}$ )	97.4%
CEC efficiency	96.5% (208 Vac) 97.0% (240 Vac)
Stand-by consumption	< 8.0 Wrms
Night-time consumption	< 0.6 Wrms
Auxiliary Output	
Isolated Auxiliary Power Supply <sup>(1)</sup>	24Vdc, 0.4A max
Embedded Communication	
Embedded Communication interface	Wireless <sup>(2)</sup>
Embedded Communication Protocol	ModBus TCP (SunSpec)
Commissioning Tool	Web User interface
Monitoring	Plant Portfolio Manager, Plant Viewer, FIMER Ability™ Energy Viewer for solar plants



## UNO-DM-6.0-PLUS-US-QU

<b>Optional board UNO-DM-COM Kit</b>	
Optional Communication Interface	RS485, Alarm/Load manager relay, Remote ON/OFF
Optional Communication Protocol	ModBus RTU (SunSpec), Aurora Protocol
<b>Optional board UNO-DM-PLUS-Ethernet COM Kit</b>	
Optional Communication Interface	Ethernet, RS485, Alarm/Load manager relay, Remote ON/OFF
Optional Communication Protocol	ModBus TCP (SunSpec), ModBus RTU (SunSpec), Aurora Protocol
<b>Environmental</b>	
Ambient air operating temperature range	-13°F to +140°F (-25°C to +60°C) derating above 113°F (45°C)
Relative Humidity	5-100% RH condensing
Acoustic noise emission level	< 50 db (A) @1m <sup>(4)</sup>
Maximum operating altitude without derating	6560ft (2000m)
Environmental class	Outdoor
<b>Mechanical specifications</b>	
Enclosure rating	Certified to NEMA Type 4X
Cooling system	Natural convection
Dimensions (H x W x D)	28.7 x 21.8 x 7.1in (737 x 559 x 178mm) <sup>(3)</sup>
Weight	47.4lb (21.5kg) <sup>(3)</sup>
Mounting system	Wall bracket
Conduit connections	Bottom: Markings for (2) concentric KOs 1", 3/4" and (2) KOs 1/2" Sides: Markings for concentric KOs 1", 3/4" <sup>(3)</sup>
<b>Safety</b>	
Insulation level	Transformerless (floating array)
Safety and EMC standard	UL1741, IEEE1547.1, CSA-C22.2 N. 107.1-01, UL1998 UL 1699B, FCC Part 15 Class B
Grid standard	UL 1741 SA, IEEE 1547, Rule 21, Rule 14 (HI)
Safety approval	cTUVus

1. The auxiliary output is used to supply the RSD contactors when required
2. WLAN IEEE 802.11 b/g/n @2,4GHz
3. When equipped with DC switch and wiring box
4. @ Pure sine wave condition.

**Note. Features not specifically listed in the present data sheet are not included in the product**

## Response to abnormal conditions

### Abnormal grid conditions

The inverter is programmed to respond to abnormal grid conditions, as specified in the below table:

Condition	Utility Source		Max. time (sec) <sup>2</sup> at 60Hz before cessation of current
	Voltage (V)	Frequency (Hz)	
A	$<0.50 V_{nom}^1$	Rated (60Hz)	Default setting <sup>3</sup> 0.16 (Adj. 0.16 to 1.5)
B	$0.50 V_{nom}^1 \leq V < 0.70$	Rated (60Hz)	Default setting <sup>3</sup> 3 (Adj. 0.16 to 30)
C	$0.70 V_{nom}^1 \leq V < 0.88$	Rated (60Hz)	Default setting <sup>3</sup> 2 (Adj. 0.16 to 30)
C	$1.10 V_{nom}^1 < (*)$	Rated (60Hz)	Default setting <sup>3</sup> 1 (Adj. 0.16 to 30) (*)
D	$1.20 V_{nom}^1 \leq V (*)$	Rated (60Hz)	Default setting <sup>3</sup> 0.16 (Adj. 0.001 to 0.16 sec)
E	Rated	Default setting <sup>3</sup> $f > 60.5 \text{ Hz}$ (Adj. 60.1 to 64.0 Hz)	Default setting <sup>3</sup> 0.16 (Adj. 0.16 to 300 sec)
F	Rated	Default setting <sup>3</sup> $f < 59.3 \text{ Hz}$ (Adj. 56.0 to 59.9 Hz)	Default setting <sup>3</sup> 0.16 (Adj. 0.16 to 300 sec)
G	Rated	Default setting <sup>3</sup> $f < 57.0 \text{ Hz}$ (Adj. 50.0 to 56.0 Hz)	0.16 (Fixed)
H	Rated	Default setting <sup>3</sup> $f > 63.0 \text{ Hz}$ (Adj. 62.0 to 64.0 Hz)	0.16 (Fixed)

1.  $V_{nom}$  is the nominal output voltage rating.

2. Trip limit and trip time accuracy specification is as follows: Voltage: +/-2%, Frequency: +/- 0.10Hz, Time: 2 grid cycles (33ms @ 60Hz).

3. Default settings aligned with IEEE 1547-2003 requirements.

To adjust voltage and frequency and disconnect times to meet local utility requirements, make modifications are made using:

- The inverter embedded web user interface. The Admin password is required to unlock the "installer" functionalities.
- The LCD display. A time-limited service password is required, contact FIMER solar inverter technical support 1-877-261-1374.
- Aurora Manager LITE software. Connect the inverter equipped with UNO-DM-COM kit UNO or UNO-DM-PLUS-Ethernet COM kit to a PC through a RS-485/USB adapter. Download the manual at [www.fimer.com](http://www.fimer.com). An User ID and a password is required to unlock the "installer" functionalities of the software, contact FIMER solar inverter technical support 1-877-261-1374.

### Fault currents and durations

During a grid fault including a short circuit condition, the inverter may inject current into the grid as specified below:

Utility voltage (V)	Fault current RMS (A)		
	1 cycle	3 cycle	5 cycle
208	17.4	15.9	15.8
240	17.1	16.5	16.0

### Output power derating at high ambient temperature

Under high ambient temperatures, the inverter is designed to automatically reduce its output power. Detailed derating curves by model are provided in the product manual found on [www.fimer.com](http://www.fimer.com).

## Grid support function

The inverter is equipped with advanced grid support functionality that is useful to support reactive loads and also assist in reliable operation of the utility grid in the presence of a large number of distributed energy generation sources. This section provides an overview of the available grid support functions.

The parameters related to the grid support functions that are in this inverter can be modified by:

- Accessing the embedded Web User Interface.
- Accessing to settings under the Service menu requires a time-limited password, which can be obtained by calling FIMER solar inverter technical support at 1-877-261-1374.

### 1. Voltage ride-through

This inverter provides parameters to respond to undervoltage and overvoltage events. The inverter is designed to operate normally within the specified operating range. If voltage excursions occur, the inverter is designed to continue operating normally or cease to export power for a specified delay. After this programmed delay, the inverter disconnects from the grid if the voltage is still out of its normal range. The voltage ride-through parameters can be adjusted.

### 2. Frequency ride-through

This inverter provides parameters to respond to underfrequency and overfrequency events. If frequency excursions occur, the inverter is designed to continue operating normally for a specified delay. Beyond this programmed delay, the inverter disconnects from the grid in the event of an abnormal voltage condition. The frequency ride-through parameters can be adjusted.

### 3. Reactive power modes

This inverter is designed to export active as well as reactive power into the utility grid. The inverter provides several modes of operation for reactive power control and are described below:

- Disable: This is the default setting. Under this setting, the inverter exports with a power factor of 1.0.
- Fixed power factor control (Fixed cos-phi): In this mode, the operator can set the output power factor to a fixed value. When enabled, Set percentage will appear on the display, allowing the setting of the value of Cos-Phi as a percentage from 0.1 to 100.
- Power factor as function of output power (Std cosphi 0.9): In this mode, the inverter reduces the output power as a function of the output power at a given operating point.
- Dynamic Volt/VAR control (Std Q(U)): In this mode, the level of reactive power exported by the inverter is a function of the operating grid voltage, also known as a Volt/VAR curve.

#### 4. Power reduction

This inverter has two modes for active power reduction:

- Power limitation: When enabled, this mode limits the active power that the inverter can export to the grid. The setting is specified as a percentage of the rated power of the inverter, from 0% to 100% in steps of 1%.
- Frequency/Watt function (Set F Derating): In this mode, the inverter limits the active power as a function of the grid frequency. The default frequency/watt can be adjusted.

#### 5. Ramp controls

The inverter is designed to control the rate at which output power is increased, either at startup, or after a temporary low power condition on the PV array (such as fast shading). The following ramp controls are provided on this inverter.

- Normal ramp: The normal ramp defines the maximum rate at which the inverter can increase the output power under normal operation. The normal ramp control limits the dramatic fluctuations in the output power in order to prevent instabilities on the utility grid. The normal ramp rate can be adjusted.
- Slow ramp: The soft-start ramp defines the maximum rate at which the inverter can increase the output power when the inverter is first starting up. This startup may occur on a daily basis or when the inverter restarts after an abnormal grid event has ended.



*Refer to the dedicated application note “Grid Support Function - Application Guideline” in the FIMER Solar website for more details about the grid support functions.*

## Torques

To maintain the NEMA 4X rating of the inverter and for correct installation, the following torques must be used:

Front cover fastening screws 05	2.5Nm (1.8 ft-lb)
Screw for Protective Earth (PE) connection point 19	2.0Nm (1.5 ft-lb)

## Outer dimensions

The outer dimensions (inches) include the wall installation bracket.

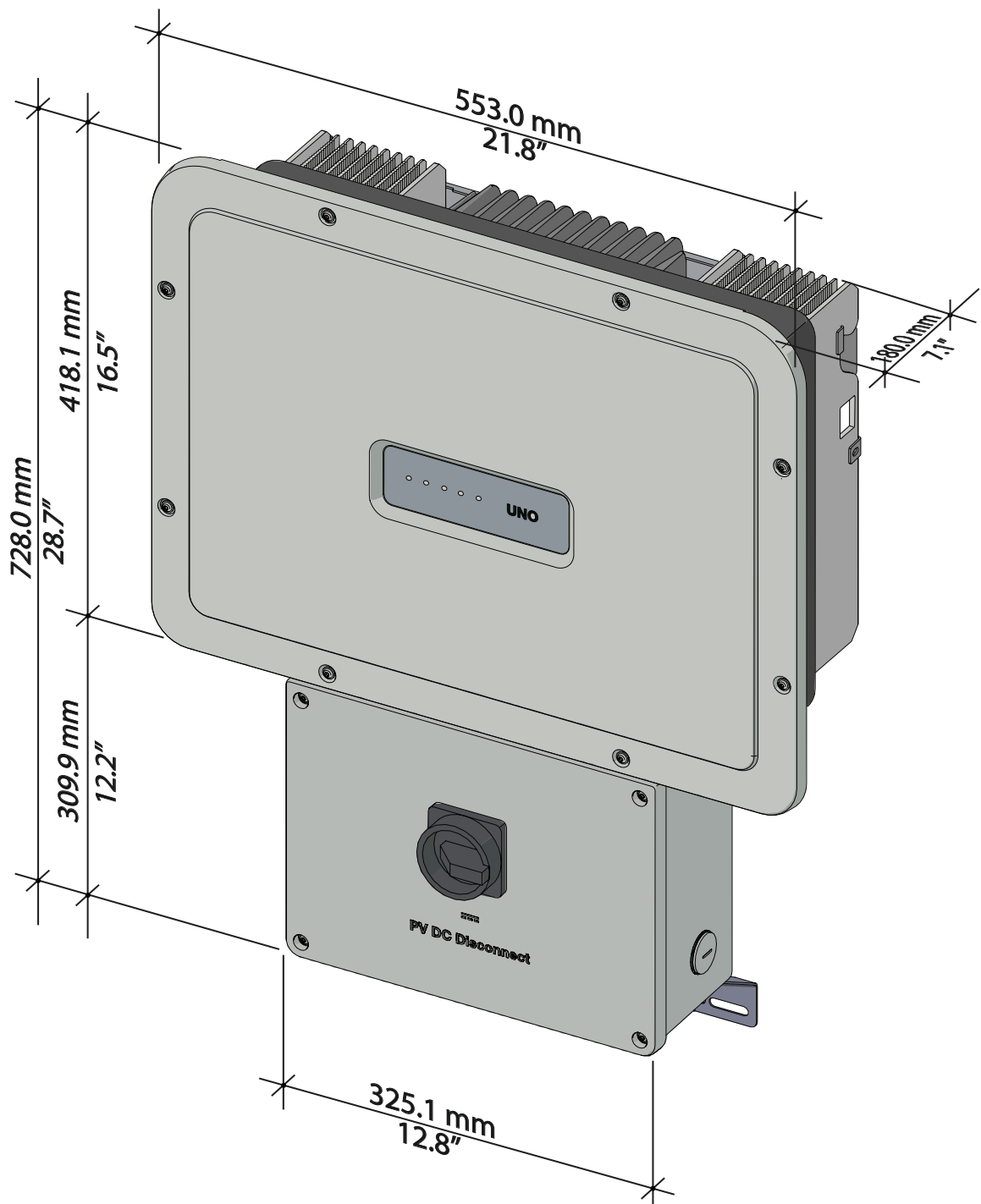

### Bracket dimensions

The dimensions of the wall mounting bracket are expressed in inch.

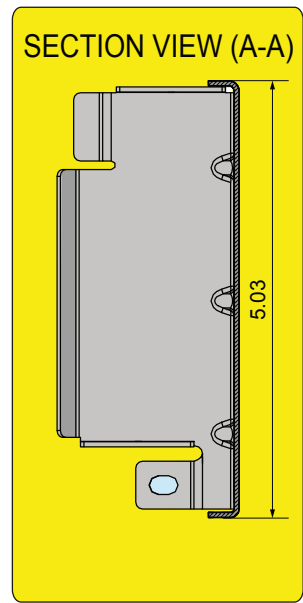
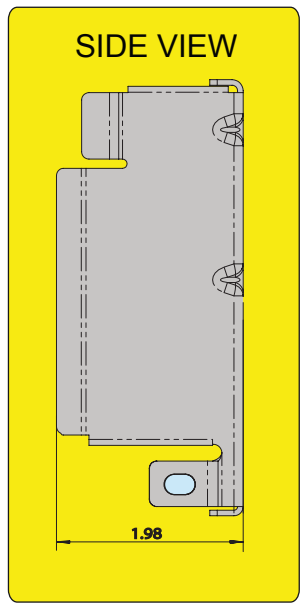
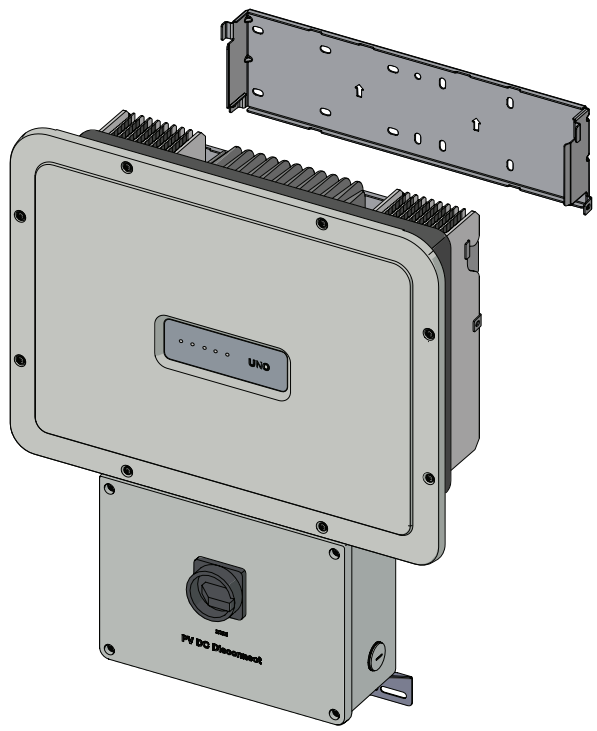
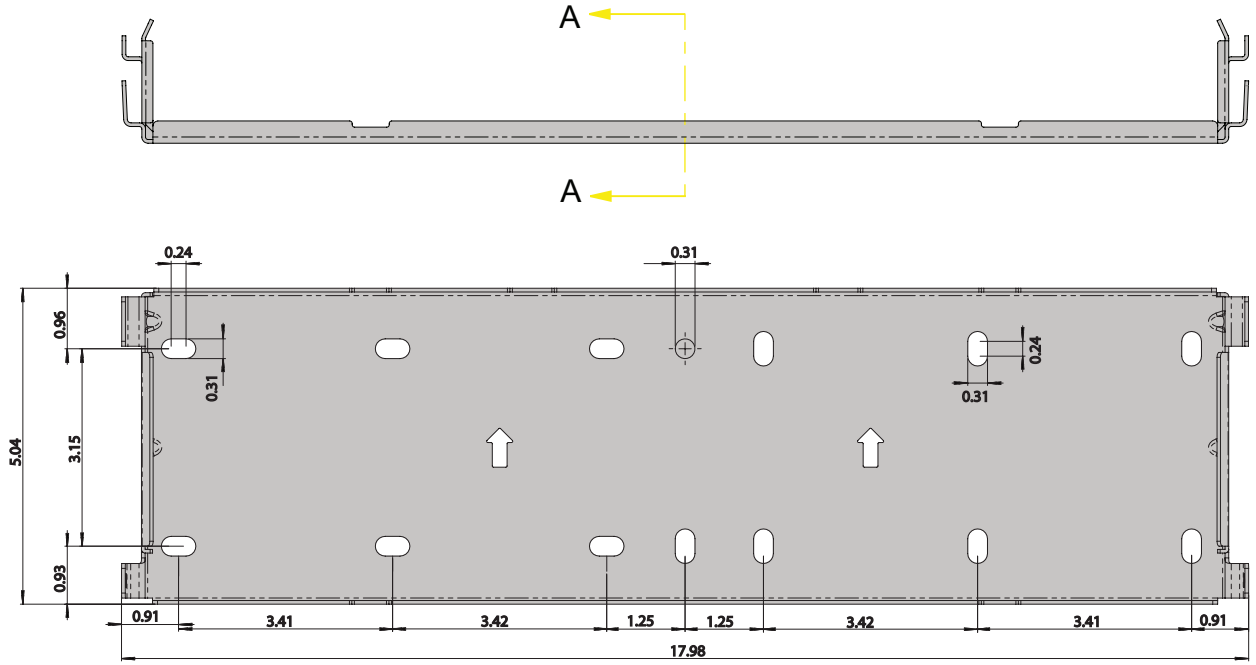

## Efficiency curves

The equipment was designed considering current energy conservation standards, to avoid waste and unnecessary leakage.

Graphs of the efficiency curves of all models of inverter described in this manual are shown below.



*The efficiency curves are linked to technical parameters that are continually being developed and improved and should therefore be considered approximate.*

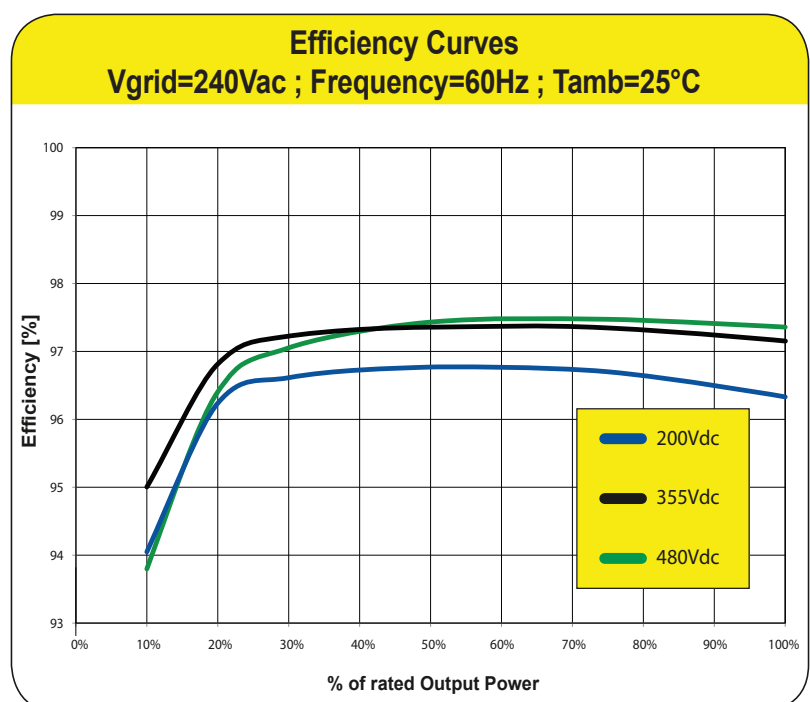
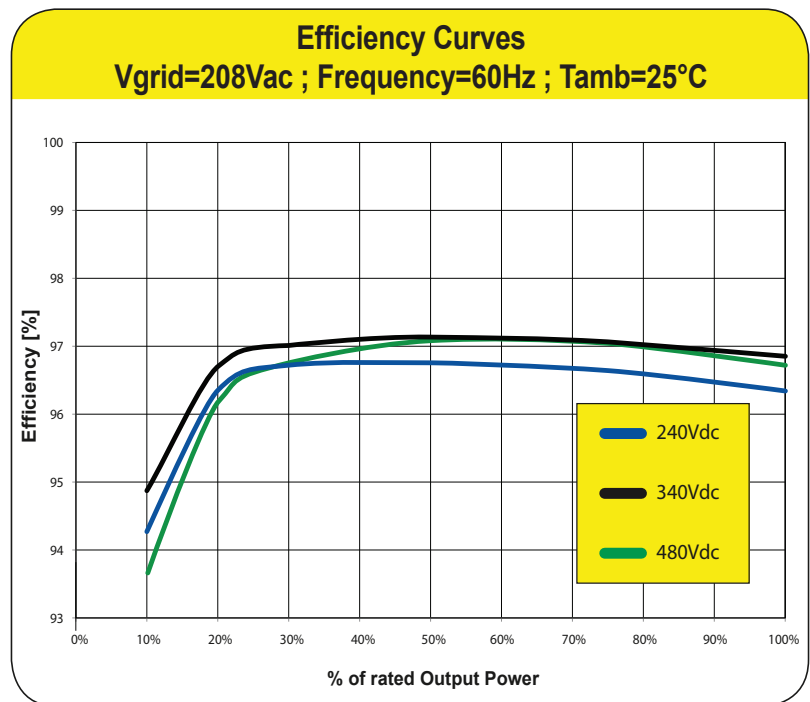

## Power limitation (Power Derating)

In order to allow inverter operation in safe thermal and electrical conditions, the unit automatically reduces the value of the power fed into the grid.

Power limiting may occur due to:

- Adverse environmental conditions (thermal derating)
- Percentage of output power (value set by the user)
- Grid voltage over frequency (mode set by user)
- Grid overvoltage  $U > 10\text{min Der.}$  (enabling carried out by user)
- Anti-islanding
- High input voltage values
- High input current values.

### Power reduction due to environmental conditions

The power reduction value and the inverter temperature at which it occurs depend on the ambient temperature and on many operating parameters. Example: input voltage, grid voltage and power available from the photovoltaic field.

The inverter can therefore reduce the power during certain periods of the day according to the value of these parameters.

In any case, the inverter guarantees the maximum output power even at high temperatures, provided the sun is not shining directly on it.

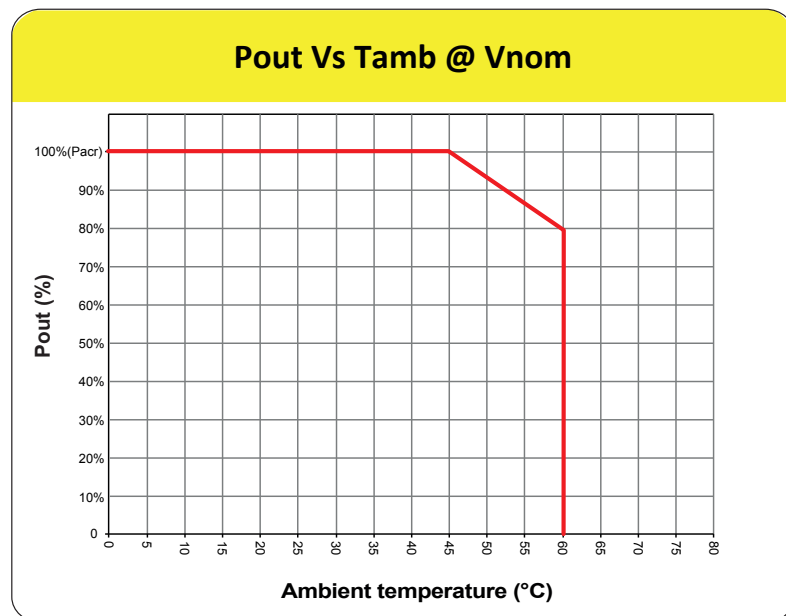



## Power reduction due to the input voltage

The graphs show the automatic reduction of supplied power when input voltage values are too high or too low.

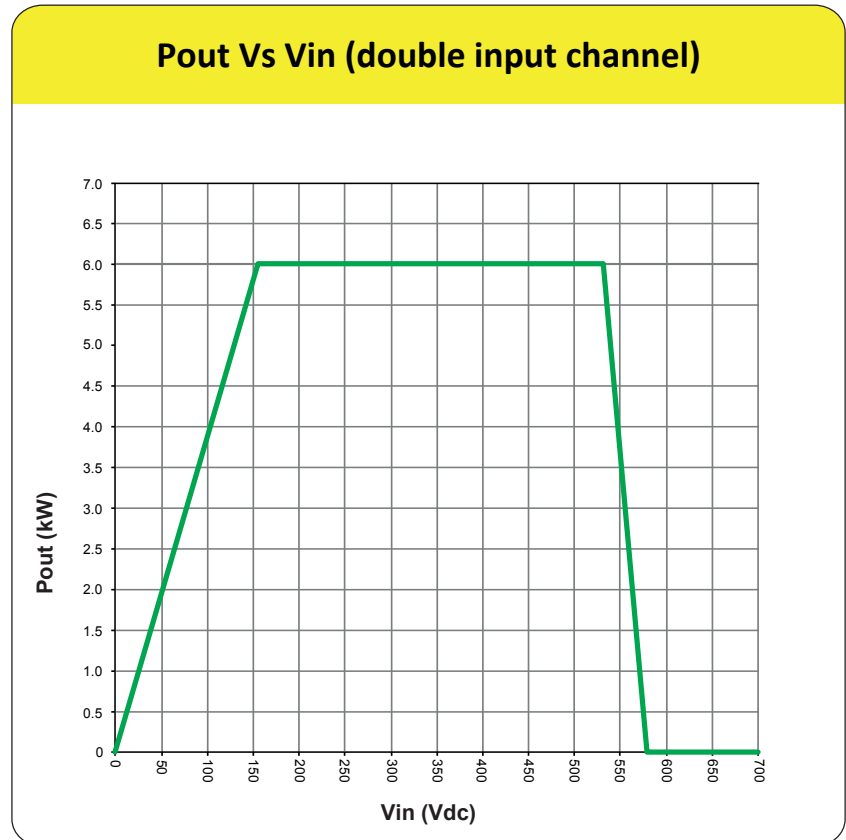

## Characteristics of a photovoltaic generator

A PV electric system consists of an assembly of photovoltaic modules that transform solar radiation into DC electrical energy and can be made up of:

**Strings: number of PV modules connected in series**

**Array: group of strings connected in parallel**

### Strings and arrays

The string technology was developed to significantly reduce the installation costs of a photovoltaic system, mainly associated to wiring on the DC side of the inverter and subsequent distribution on the AC side. A photovoltaic module consists of many photovoltaic cells mounted on the same support.

- A string consists of a certain number of module connected in series.
- An array consists of two or more strings connected in parallel.

Large photovoltaic systems can include multiple arrays connected to one or more inverters.

The greater the number of panels in each string, the lower the cost and the less complex the wiring connections of the system.

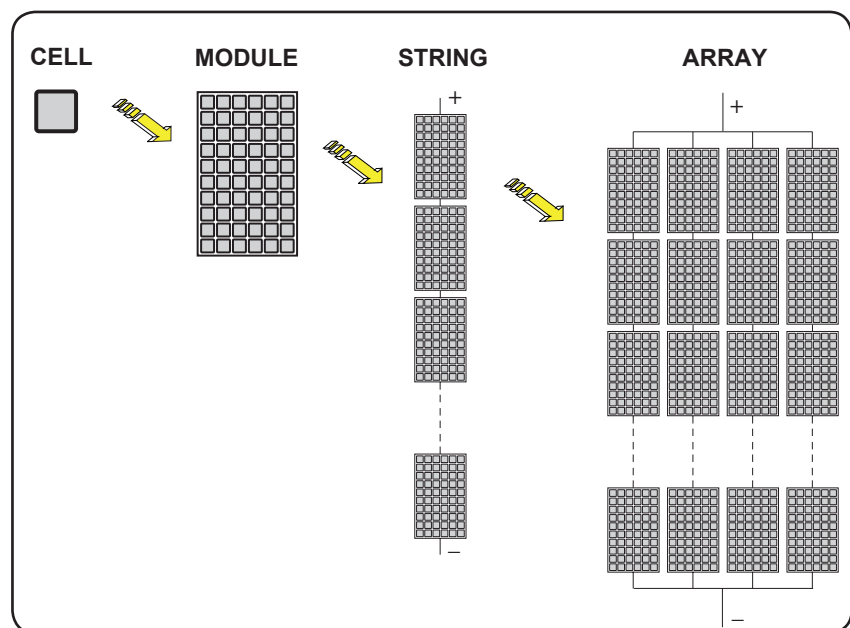

## Description of the inverter

This string inverter converts the direct current from a single PV array into alternating current, and feeds it into the electrical distribution grid.

This conversion, known as inversion from DC to AC, is done in efficiently, and electronically, without rotating machinery.

When connected in parallel with the grid, the alternating current from the inverter flows directly into a domestic or industrial distribution circuit, which is in turn connected to the public distribution grid.

The inverter automatically reduces the power fed into the grid under adverse environmental conditions, such as high temperature, unsuitable input voltages or grid instability.

### Multiple-inverter system

Multiple inverters may be used at large-capacity sites. Each inverter must have its own individual PV array input, and on the AC side, and its own AC disconnect to the grid.

Each inverter will work independently from the others and will supply the grid with the maximum power available from its section of photovoltaic panels.

### Notes on system sizing

Decisions on how to design a photovoltaic system depend on a number of factors, such as the type of panels, the space available, the location of the system, energy production goals, choice of inverter, etc.

*A setup program to help correctly size the photovoltaic system is available on the FIMER website (<http://stringsizer.fimer.com>).*

### Inverter block diagram

The diagram shows the internal structure of the inverter. It has two stages:

- DC/DC input converter (boost)
- DC-AC output inverter

The DC-DC converter and the DC-AC inverter work at high switching frequencies, and are small and relatively light.

The converter input has maximum power point tracking (MPPT) to optimize energy production.

The inverter has no internal isolation transformer (no galvanic insulation between input and output), which reduces weight and increases efficiency. It has all protection necessary for safe operation and compliance with safety standards.

The inverter's operation and management of its protection features are controlled by two independent digital signal processors (DSP) and a central microprocessor. The connection to the grid is thus controlled by two independent computers, in full compliance with requirements for connection to the grid, and for safe and secure operation.

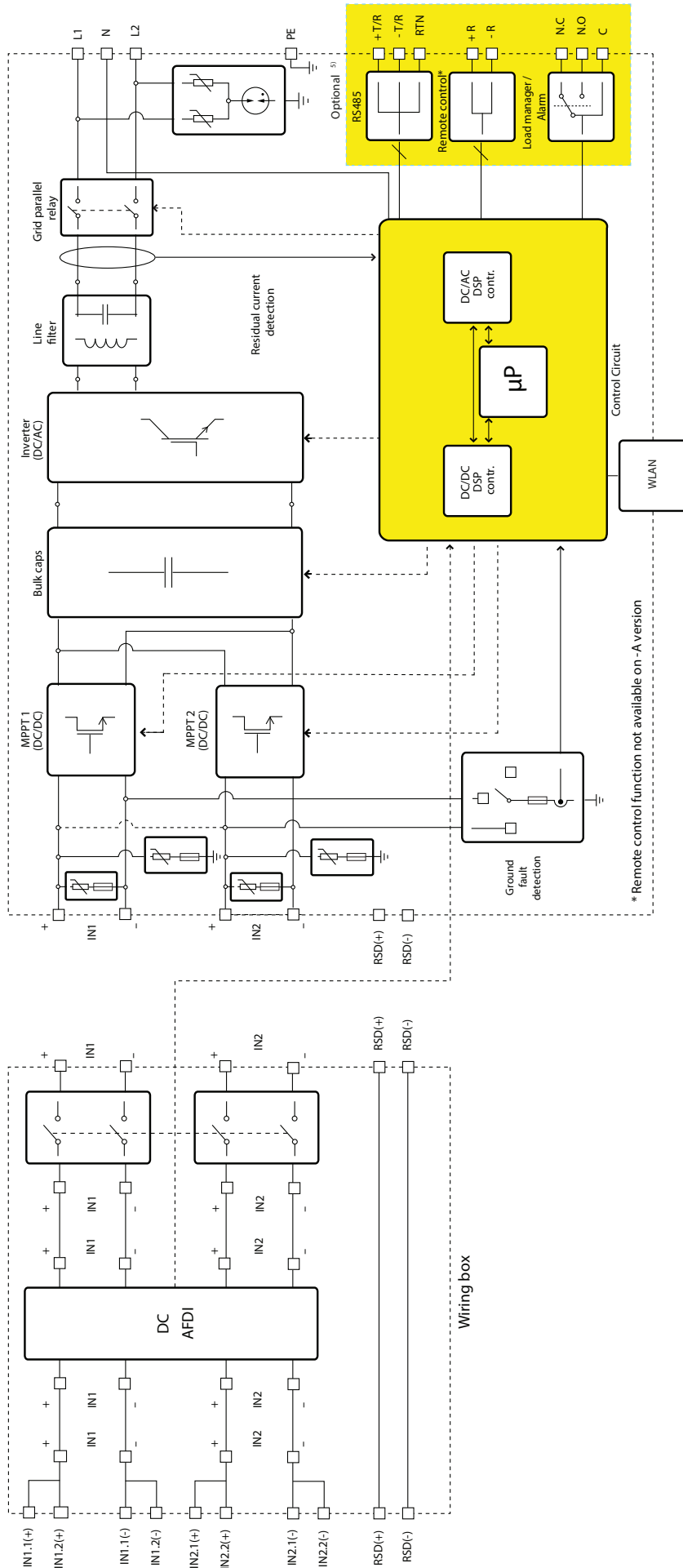

\* Remote control function not available on -A version

PV plant block diagram

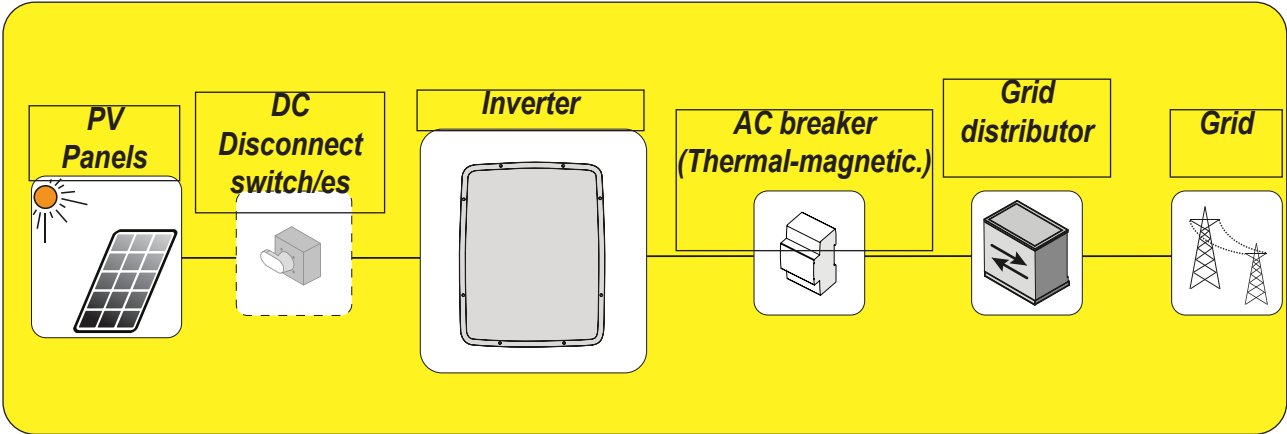

Operating diagram

The plant diagram shows how the integrated WLAN board allows the inverter to connect to a LAN local network using a wireless connection. The WLAN board features an advanced integrated webserver that enables to establish a direct connection to a PC, smartphone or tablet, allowing for inverter setup and local monitoring of the inverter.

When the inverter is connected to the WLAN network with access to the Internet, the device allows data to be transferred to the Aurora Vision® CLOUD platform for Internet monitoring using the Plant Portfolio Manager / Plant Viewer / Plant Viewer for Mobile (Mobile App).

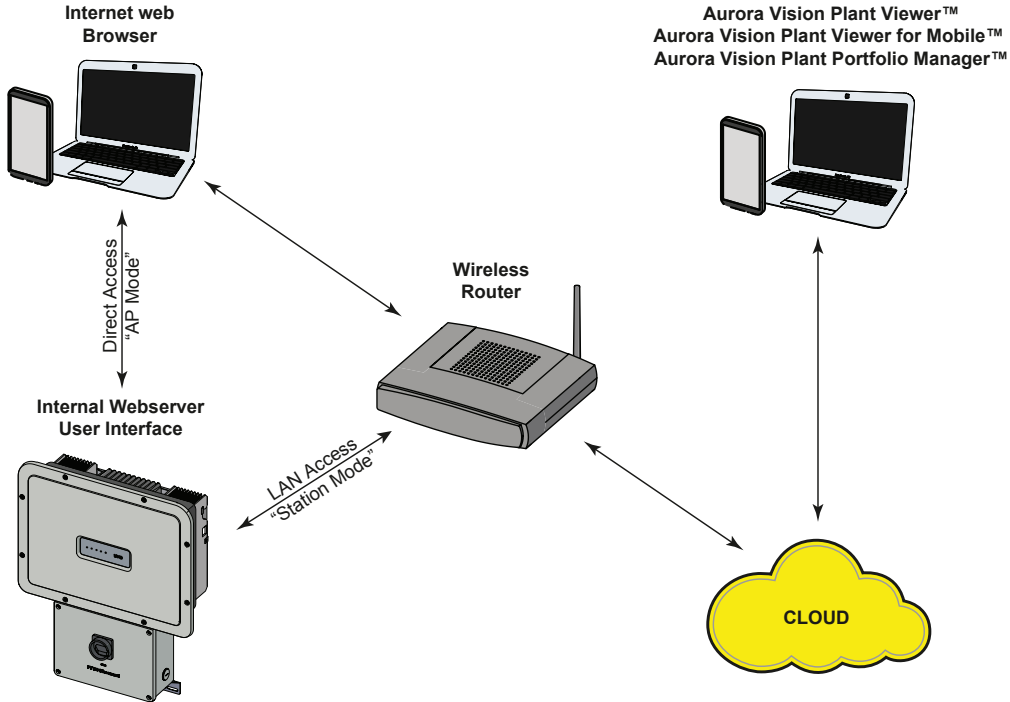

## Default functionality and components of the inverter

### - Advanced internal webserver

The UNO-DM-TL-PLUS inverters are equipped with a WLAN board IEEE802.11 b/g/n and with an internal webserver that allow comissioning of the system, a full access to all main configuration and parameters of the inverter and can act as local monitoring solution. It can be accessed by using from any wireless capable device like laptop, tablet or smartphone via a common browser.

### - Aurora Vision Plant Management Platform

Aurora Vision is a cloud based platform enabling remote monitoring and asset management of FIMER devices in range of solar power application.

Aurora Vision consists of a three different product:

1. **Plant Portfolio Manager** is a full featured web based application used by solar power professionals to monitor and manage a portfolio of solar power plants using FIMER inverters.
2. **Plant Viewer** is an easy to use web based serviced application used by non-solar power professionals (such as homeowners or small business owners) to monitor solar power plants they own.
3. **Plant Viewer for Mobile** is the mobile version of **Plant Viewer** enabling non-solar power professionals to remotely monitor their own PV plants by using smart phones, tablets and iPod Touch with IOS and Android operating systems.

All three product previously mentioned work together to allow solar power professional and site owners to collaboratively manage solar power plant.

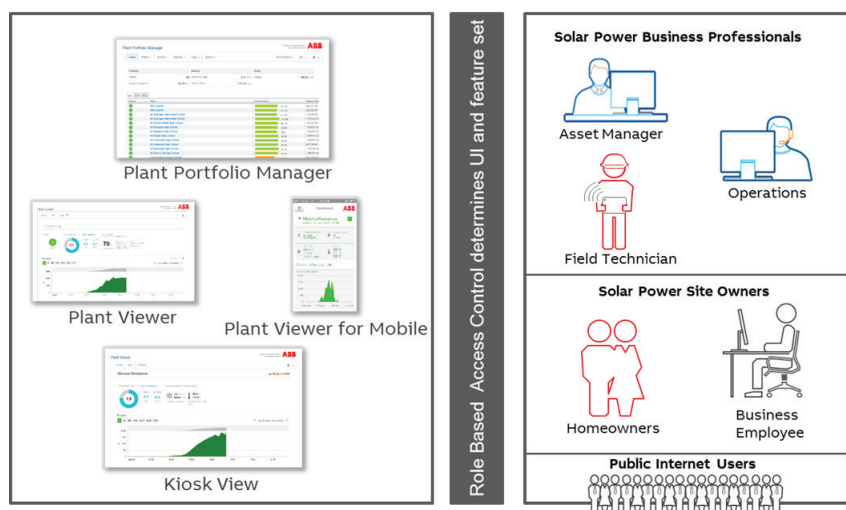

Please contact the FIMER technical support for getting your own plant portfolio manager account (mainly for installers and plant administrators). Please get your Plant Viewer and Plant Viewer for Mobile by accessing the website [www.auroravision.net](http://www.auroravision.net) and click on "Register with Plant Viewer" button (mainly for site owners).

#### - Remote Firmware Update Function

The inverter firmware can be updated remotely using the internal web-server dedicated section.

#### - Reactive power feed into the grid

The inverter is able to produce reactive power and can feed this power into the grid via the phase factor setting. Managing the feed can be set by the internal webserver.

Power feeding modes vary according to the country of installation and the grid companies. For detailed information on the parameters and characteristics of this function, contact FIMER directly.

#### - Limiting the active power fed into the grid

Can limit the amount of active power fed into the grid by the inverter to the desired value (expressed as a percentage).

#### - Rapid shutdown (RSD) power supply

The inverter has 24Vdc (0.4A max) power supply on a spring-loaded terminal block inside the wiring box, which is designed to be used to power-up a RSD device.

## Functionalities available with accessory board

The inverter can be equipped with advanced accessory board (UNO-DM-COM KIT or UNO-DM-PLUS-Ethernet COM KIT) adding either:

**- An RS-485 serial interface or the Ethernet communication interface** enabling the inverter to be used in one of the following operating mode:

#### Modbus Sunspec certified interface:

Thanks to the Modbus RTU/TCP communication protocol (Sunspec compliant), the inverter can be easily integrated with third party monitoring and control system by using the accessory board (UNO-DM-COM KIT or UNO-DM-PLUS-Ethernet COM KIT).



*Please contact the FIMER technical support or get access to Sunspec alliance website for getting the Modbus register map supported by the inverter.*

#### - Configurable relay:

The advanced accessory board provides also a configurable switching relay, which can be used in different operating configurations that can be set in the dedicated menu.

A typical example of application is the activation of the relay in the event of an alarm.

#### **- Remote switch-on/switch-off**

This command can be used to switch off/switch on the inverter via an external (remote) command.

This function must be enabled in the menu and when active, switching on the inverter, besides being dictated by the presence of normal parameters which allow the inverter to be connected to the grid, also depends on the external command for switching on/off.



## Safety devices

### Anti-Islanding

In the event of a local utility company grid outage, or when the equipment is switched off for maintenance, the inverter must be physically disconnected to ensure protection of people working on the grid, all in accordance with the relevant national standards and laws. To prevent possible islanding (the condition in which a distributed generator continues to power a location even though electrical grid power from the electric utility is no longer present), the inverter is equipped with an automatic disconnection system called an Anti-islanding system.

### Photovoltaic panel ground fault

This inverter must be used with photovoltaic modules connected with “floating” connections - that is with positive and negative terminals that are not grounded. An advanced ground fault protection circuit continuously monitors the ground connection and disconnects the inverter when a ground fault is detected. The ground fault condition is indicated by a red LED on the front panel.

### Arc Fault Detection (AFD)

This safety function allows the inverter to recognize series electrical arcing on DC cables. If arcing is detected, the inverter turns itself OFF, disconnects from the grid, and remains disconnected until manually reset.

An AFD fault is reset by pressing the button on the left side of the DC wiring box, but a thorough check of the DC cables and panels must be completed first, to locate the source of the arcs.

The AFD circuitry runs a self-test at each power up.

### Ground fault detection and interruption scheme

As required by UL1741 CRD 2010, the inverter incorporates two separate methods for detecting a ground fault in the ungrounded PV array. These are described below:

#### **Method 1: Pre-Start (Static RISO)**

Any time conditions are suitable for the inverter to be connected to the grid, internal circuitry measures the insulation resistance (RISO) of the PV array conductors to ground. If the result of this static insulation resistance test is less than the pre-programmed threshold, the connection is aborted, the inverter will show an error, and illuminate the red LED GF indicator on the inverter's front panel. This test is conducted prior to any attempt to connect to the grid; e.g., at daybreak and any other time during the day where the inverter has been disconnected from the grid.

#### **Method 2: Post Grid Connection (Dynamic Leakage Current)**

While the inverter is connected to the grid, the inverter circuitry continuously checks for ground fault conditions using a differential measurement of the

AC line, searching for any values that would indicate leakage of current to ground. Measurement of the ground leakage current is carried out simultaneously by two independent and redundant processors. If either processor detects an unacceptable value as defined below, the inverter will immediately be disconnected from the grid, and it will illuminate the red LED GF indicator on the inverter front panel.

The inverter responds differently depending on the level and duration of leakage current detected. If any of the following conditions is detected in measured values of differential current (IDIF) or a rapid change of IDIF over time ( $\Delta IDIF/\Delta t$ ), the inverter will automatically disconnect from the grid and the red front panel GF LED will illuminate:

- If  $IDIF > 300$  mA for a period of 300 msec
- If  $\Delta IDIF/\Delta t > 30$  mA/sec for a duration of 300 msec
- If  $\Delta IDIF/\Delta t > 60$  mA/sec with duration of 150 msec
- If  $\Delta IDIF/\Delta t > 150$  mA/sec with duration of 40 msec

As a further safety precaution, in compliance with UL1741 CRD 2010, the inverter conducts an isolation monitor interrupter self-test before connecting to the grid, or every 24 hours, whichever is sooner. This test confirms that the circuitry needed to perform the isolation test is operating normally, and has not been damaged.

Ground fault errors are permitted to occur up to four times within a 24-hour period, after which a fifth ground fault error within a 24 hour period requires a manual reset. The system must be given a thorough examination before the reset, the cause of the ground fault located and corrected. This is intended to ensure equipment with a ground fault is not connected to the grid.

## Other safeguards

The inverter also has:

- Constant monitoring of the grid voltage to ensure the voltage and frequency remain within operating limits;
- Internal temperature control to automatically limit the power (if necessary) to prevent overheating.

*The numerous control systems and redundancy ensure safe operation.*

## Lifting and transport

# 4

### Transport and handling

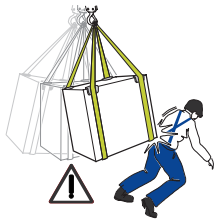

Protect the inverter from shocks, humidity, corrosive environments (e.g. salt), vibration, etc during transport and handling.

**During handling, do not make any sudden or fast movements that can create dangerous swinging.**

### Lifting

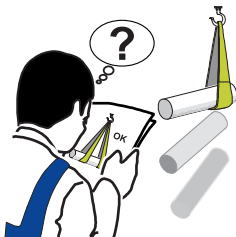

Equipment used for lifting the inverter must be rated for its weight. Do not lift more than one inverter at a time.

### Unpacking and incoming inspection

Packaging (cardboard, cellophane, staples, adhesive tape, straps, etc.) may cause cuts and/or injuries if not handled with care. It should be removed with the proper equipment.

*Packaging must be disposed of in accordance with any local regulations.*

When the packaging is opened, confirm the inverter and components are not damaged and that nothing is missing.

Immediately report any damage or missing parts to the delivery carrier and to FIMER Service.

**Storage**

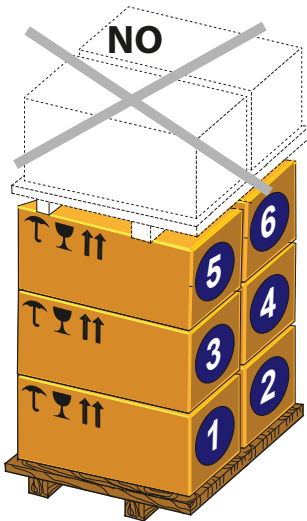

A maximum of 6 inverter may be stacked as shown in the side figure

*DO NOT stack with other equipment or products.  
Assembly brackets 01 and/or accessory components are inside the packages.*

**Weights**

Table: Weights	Weight (Kg/lb)	Lifting points (no.#)
UNO-DM-6.0-PLUS-US-Q	47.4lb (21.5kg)	2

**Lifting**



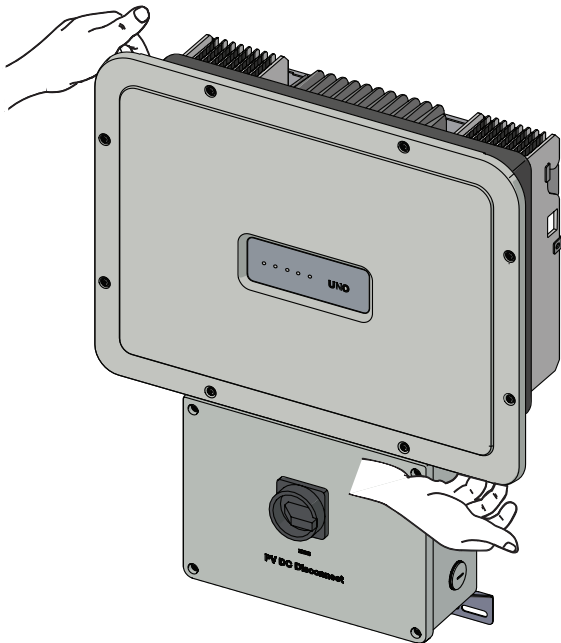

The inverter can be lifted by hand by one person without handles or eye bolts. During the operations of lifting make sure to grab the inverter chassis (dark grey surface) located on the rear of the inverter front cover 04. Don't grab the inverter front cover 04 only (light grey part)!

**Lifting points:**

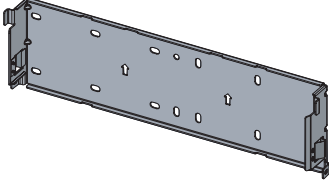

## Packing list

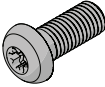
All components required for installation (listed in the below table) are shipped with the inverter.

Components		Quantity
	Bracket for wall mounting	1
	M5x10 Wall bracket locking screw (to be used if required)	2
	M5 Wall bracket locking washer (to be used if required)	2
	(Spare part) T20 screw for front cover	1
	Cables for the configuration of the input channels in parallel	1+1
	Technical documentation	1

## Installation warnings



*The inverter must be correctly installed, in a suitable location, to operate properly and safely.*



*Installers must know and understand applicable NEC requirements and any local codes for photovoltaic systems.*



*Installers must know and understand OSHA and other applicable safety requirements, including lockout/tagout procedures.*



*Remember that when the photovoltaic panels are exposed to sunlight they provide continuous DC voltage to the inverter. Before installation may begin, photovoltaic panels must be shaded or isolated.*



*Before installation may begin, the inverter must be disconnected from the grid (power disconnect switch open and external AC disconnect locked out/tagged out) .*



*Limit installation to licensed electricians experienced in PV plant wiring.*



*Obtain approval of the local AHJ before connecting the inverter to the electrical grid*



*The equipment owner must post the PPE level per NFPA TDE-2012, Table 13*

## Installation site and position

- Consult technical data to confirm the environmental specifications will be met
- Installation of the unit in a location exposed to direct sunlight must be avoided (otherwise the warranty will be voided) as it may cause:
  - power limitation phenomena in the inverter (with a resulting decreased energy production by the system)
  - premature wear of the electrical/electromechanical components
  - premature wear of the mechanical components (gaskets)
- Do not install in closed spaces where air does not freely circulate
- Do not install in spaces inhabited by people or animals due to the potential audible noise level of an operating inverter.
- Always ensure that the airflow around the inverter is not restricted or blocked, so as to prevent overheating.
- Do not install the equipment near flammable substances
- Do not install the equipment on wooden walls or supports, or other flammable substances.
- Maintain minimum clearance from objects blocking air circulation and maintain minimum spacing between inverter as indicated in the figures.

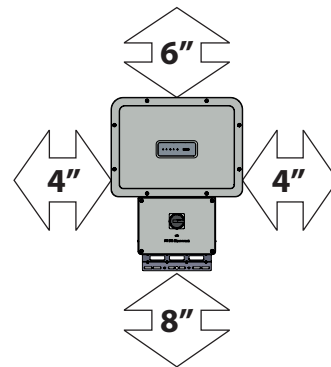

- Maintenance on device hardware and software entails removing the front covers. Check that the correct installation safety distances are observed in order to allow routine check and maintenance operations.
- Install on a wall or strong structure capable of bearing the weight
- Ensure sufficient working area in front of the inverter for wiring box access
- If possible, install at eye level so that the LEDs can be easily seen
- Install at a height that takes account of the weight of the equipment
- All installations over 6500' (2,000 meters) must be assessed by FIMER Technical Sales to determine the proper datasheet derating
- Install vertically with a maximum inclination of 5° (forward or backward). If this condition cannot be met, the inverter could undergo derating due to high temperature because of poor heat dissipation.

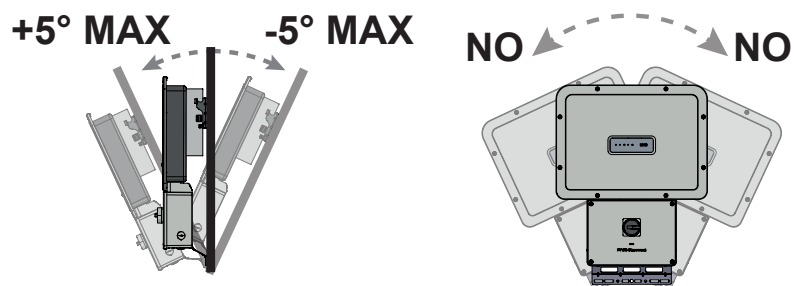

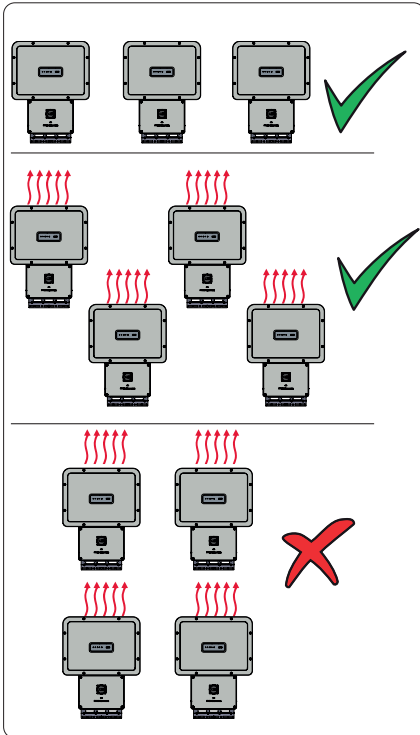

- Position multiple inverters side by side, maintaining at least minimum clearances, measured from the outermost edge of the inverter. Keep in mind clearance and approach required for any removal or replacement!

- Multiple inverters can also be placed in a staggered arrangement. Minimum clearances for staggered arrangements include the width of inverter plus additional allowances for inverters arranged above or below



*Do not block access to the external AC and DC disconnects.*



*Please refer to the warranty terms and conditions to avoid any possible warranty exclusions due to improper installation.*

### Installation sites with high humidity



*Do not open covers to install the inverter if there is precipitation or >95% humidity. Always carefully seal all unused openings.*

Even though the device is equipped with an anti-condensation valve, air with extremely high levels of humidity can lead to moderate/low condensation phenomena inside the inverter.

In fact since the inverter is almost completely insulated from the outside once the covers are back in place, after the installation, still some damp air could remain trapped inside the wiring boxes and determine moderate condensation level lately when the temperature drops down at night.



## Wireless signal environmental checks

The WLAN board of the inverter uses radio waves to transmit and receive data, it is therefore important to assess this factor in order to have optimal installation.

- Walls in reinforced cement and surfaces covered in metal (doors, shutters, etc.) can markedly reduce the reach of the device which even in optimal conditions, should be of approximately 50 metres in free space.
- It is therefore recommended that before installing the inverter, the strength of the wireless signal is checked, using a mobile device (smartphone, tablet or notebook) and connecting to the wireless router from a position which is close to the installation site of the inverter.

Some installation examples are provided below in different conditions and with the maximum recommended distances between the Inverter and the wireless router.

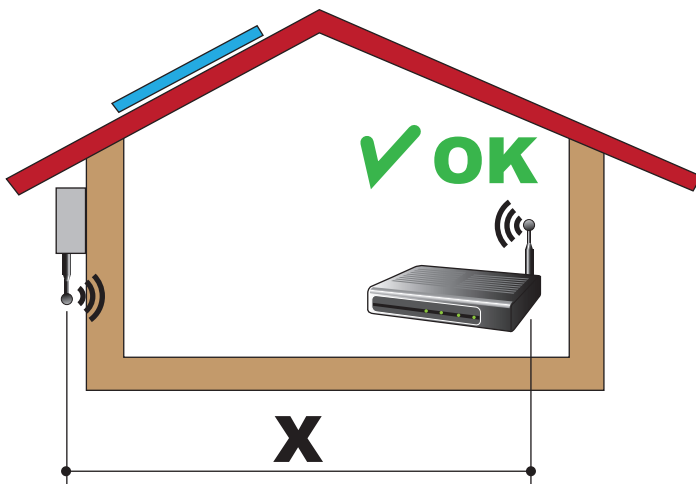

**Material of the structure:** Wood

**Distance X between the Inverter and the wireless Router:** less than 10m/33ft

**Installation:** permitted

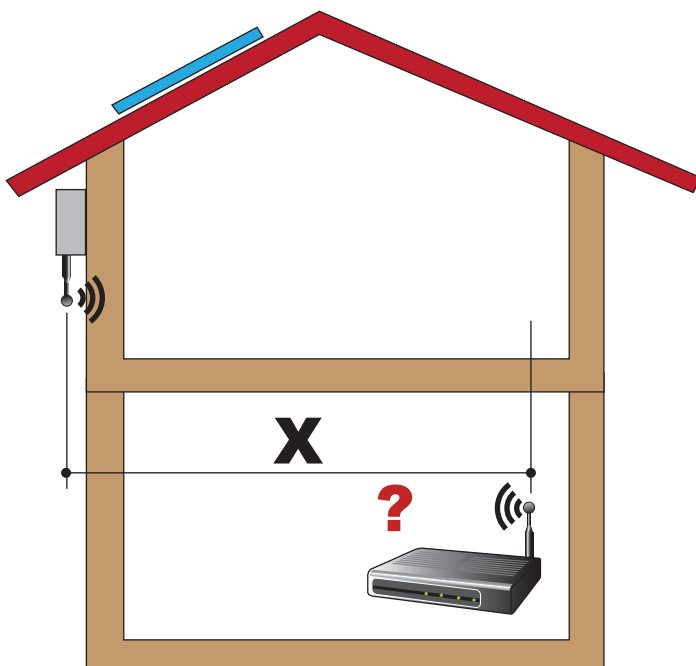

**Distance X between the Inverter and the wireless Router:** greater than 10m/33ft and/or with obstacles or floors to pass through.

**Installation:** to be evaluated. Assess the quality of the RF signal and the possibility of extending the signal with a repeater or transferring the Wireless router to the floor above.

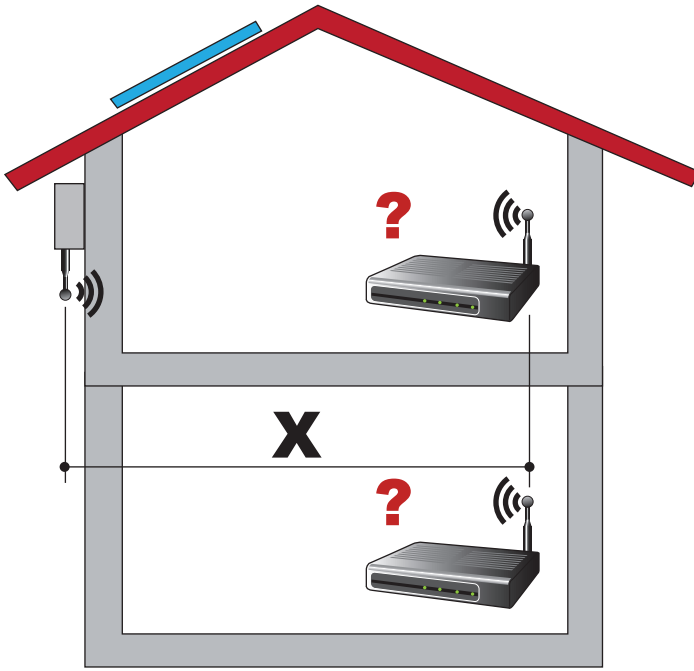

**Material of the structure:** Concrete

**Distance X between the Inverter and the wireless Router:** any distance

**Installation:** to be evaluated. Assess the quality of the RF signal and the possibility of extending the signal with a repeater.

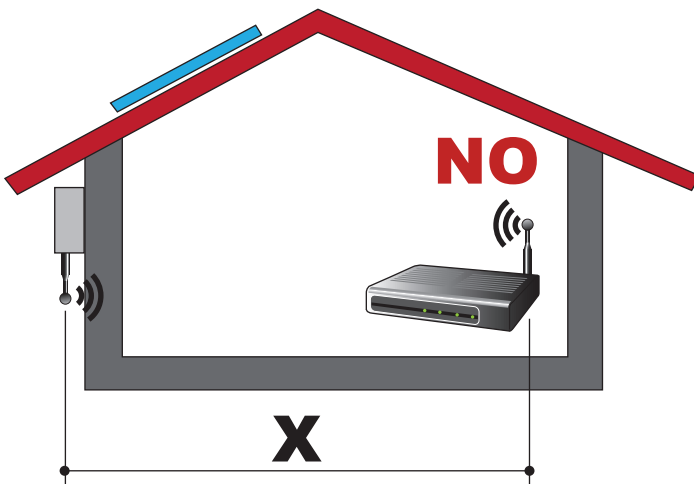

**Material of the structure:** Metal or reinforced concrete

**Distance X between the Inverter and the wireless Router:** any distance

**Installation:** not permitted. Assess the possibility of externally positioning the wireless router antenna (extension) or position the wireless router near a window (in the line of sight of the inverter)

**Material of the structure:** any material

**Distance X between the Inverter and the wireless Router:** less than 30m/100ft

**Installation:** permitted provided that the router is in the line of sight of the inverter (through a window)

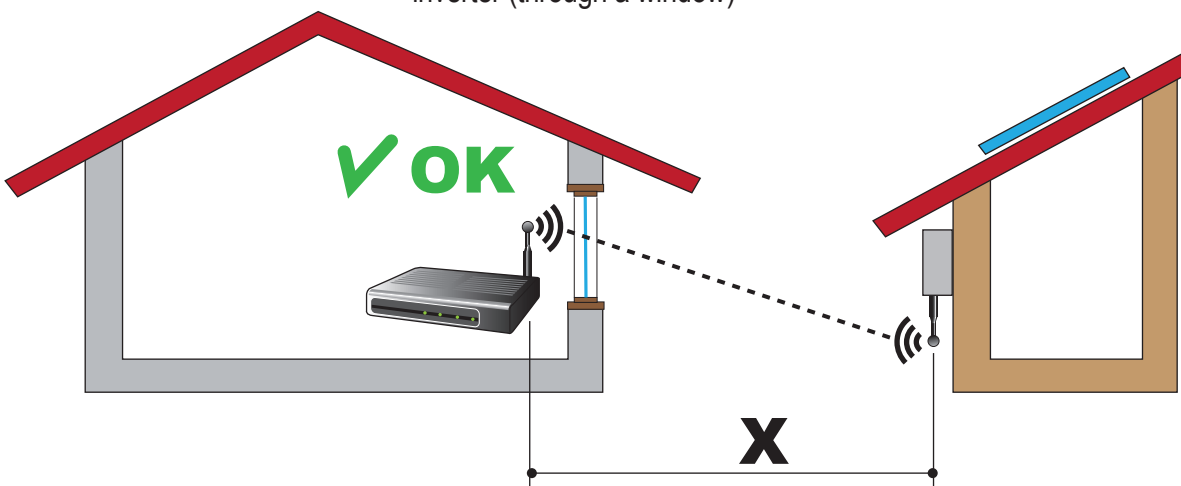

## Recommendations for the wireless signal power

The radio signal level between the inverter and the wireless router can be improved in a number of ways:

1. Find a new position for the router considering the different types of materials which the radio signal will have to pass through:

Material	Relative signal reduction
Open field	0% (strength of approximately 50 metres)
Wood / Glass	From 0 to 10%
Stone / Plywood	From 10 to 40%
Reinforced concrete	From 60 to 90%
Metal	Up to 100 %

The quality of the RF signal can be assessed during the installation stage where the signal is displayed in dBm.

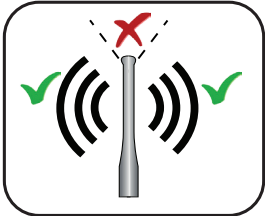

The antenna has a dead zone at its tip, which should not be positioned facing the wireless router, as shown in the figure.

2. Install a wireless signal repeater and place it in an area between the inverter and the router, trying to make sure that the most critical obstacles are avoided.

## Wall mounting



During installation do not place the inverter with the front covers 04 05 facing the ground.

Install the inverter by following this procedure:

1. Position the bracket 01 on the vertical support (pole, wall, frame, etc) and use it as drilling template. It is the installer's responsibility to choose an appropriate number and distribution of attachment points. The choice must be based on the type of wall, frame or other support, the type of anchors to be used, and their ability to support 4 times the inverter's weight (4 x 47.4lb =190 lbs for all models).

Attach the bracket to the wall with at least 4 attachment screws. Depending on the type of anchor chosen, drill the required 4 holes (minimum) A to mount the bracket.

2. Attach the bracket to the wall or frame



Risk of injury due to the weight of the equipment.

3. Lift the inverter and hang it to the bracket 01 by inserting the two supports in the slots on the inverter (Figure B).
4. Proceed to anchor the inverter to the bracket by pressing the lower part toward the wall and install the two side screws (Figure B).
5. Secure the lower bracket of the inverter to the wall or frame using an appropriate type of anchor.

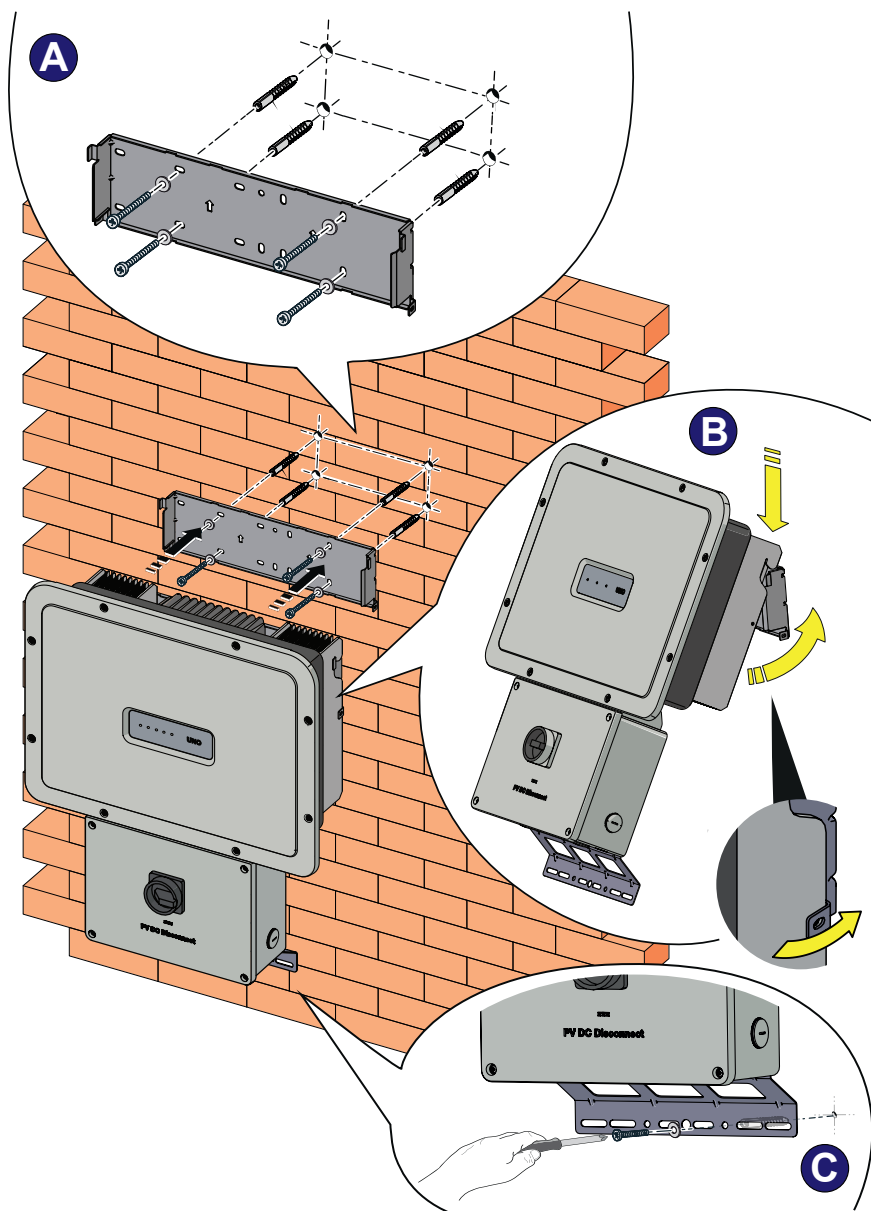

## Opening the front cover



**WARNING! ELECTRIC SHOCK HAZARD!** Hazardous voltages may be present inside the inverter. The access to the internal zones of the inverter must be carried out after a minimum waiting time of 5 minutes since the inverter was disconnected from the grid and from the photovoltaic generator.



The main connections are made on the wiring box of the inverter by removing the 4 screws, using a TORX T20 key, of the front cover 05. If required to install the accessory boards and make the necessary connections, unscrew the 8 screws, using a TORX T20 key, and open the front cover 04 of the inverter compartment; while removing the screws, pay special attention since additional screws are not supplied.



*Do not open the inverter in the case of rain, snow or a high level of humidity (>95%)*



*Caution! It's necessary to hold the front cover during the screws removal to avoid his falling (the front covers aren't secured to the inverter's chassis).*

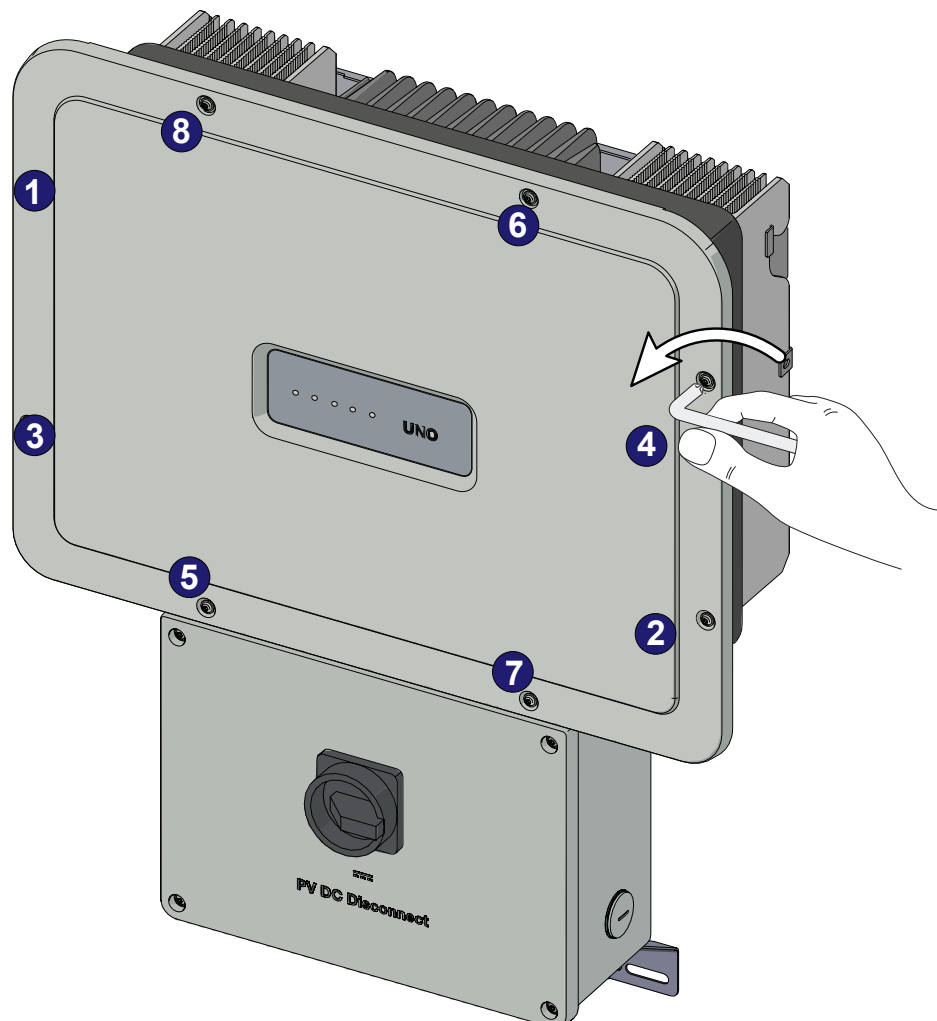

## Installation planning

Always respect the nominal ratings of voltage, current, and power defined in the technical data table, when designing your system.



Observe the following considerations in design:

To reduce the risk of fire, connect only to a circuit provided with a branch circuit overcurrent protection in accordance with NEC (ANSI/NFPA 70). See Maximum AC OCPD requirement in following paragraph.



This UNO inverter is designed without an isolation transformer and is intended to be installed per NFPA 70, 690.35 with an ungrounded PV array.



An automatic overcurrent device (e.g. circuit breaker) must be installed between the UNO inverter and the AC utility grid. It is the responsibility of the end user to provide protection for the AC output circuit.

### AC overcurrent protection

AC output overcurrent protection is not provided in the inverter; it is the responsibility of the end user to provide overcurrent protection for the AC output circuit. To reduce the risk of fire, connect only to a dedicated circuit provided with overcurrent protection in accordance with the NEC (ANSI/NFPA 70):

UNO-DM-6.0-TL-PLUS-US-Q	
Type	Typical installations use a 2-pole/600V rated, bi-directional thermal-magnetic circuit breaker, UL489 or equivalent.
Maximum Current/Voltage	UNO-DM-6.0-TL-PLUS-US-Q → 40A/600V for 208V and 240V grid

### Choice of grid output connection type (AC side)

Determine which AC output is applicable for the inverter model being installed. The AC wiring connections based on the AC grid type are shown in the table below.

GRID STANDARD TYPE DE RÉSEAU						
	208V~ 3PH - Δ			240V~ SPLIT-PHASE		
TERMINAL BORNE	1	2	3	1	2	3
WIRE CÂBLE	L1	L2	-	L1	L2	N

**Caution!** Connect the ground before the grid connections.



## Sizing the ground cable(s)

FIMER inverters must be grounded at the protective earth (PE) connection point 20  terminal.

*Size the cable(s) in accordance with NEC and any local codes.*



*The wire must be large enough to handle the maximum ground fault current that the PV system might experience.*



*The warranty is void if the inverter isn't connected to ground through the appropriate terminals.*

Follow site wiring diagrams and grounding plans. At a minimum expect this to include:

- A PV array equipment ground connection
- Inverter protective earth (PE) connection

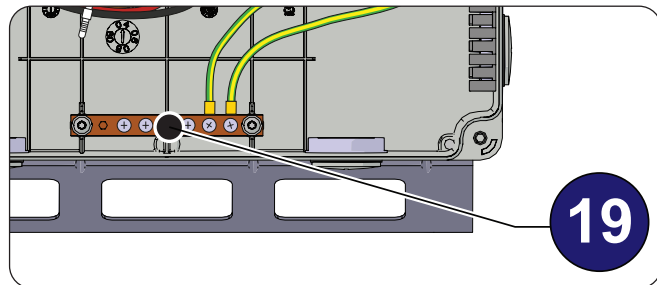

The Protective Earth (PE) connection point 19, located inside the wiring box, accept 4 wires 8AWG to 4AWG, copper (Torque to 2.0Nm / 1.5 ft-lb).

## Sizing the AC cable

The AC output conductors must be sized according to operating temperature range and continuous current ratings.

- Size conductors per NEC Article 310.
- Use 90°C wire only;
- AC wiring terminals 17 are spring pressure type and accommodate a wire size range of 20-6 AWG

Note that undersized wiring may cause nuisance tripping (disconnection) of the inverter. Too-high wiring impedance increases the AC voltage seen at the inverter terminals. In compliance with UL1741 and IEEE1547, the inverter may need to disconnect from the grid under otherwise normal grid operating conditions: IEEE1547 default settings mandate the inverter operate only if its terminal voltage is in the  $[+10\%/-12\%] \cdot V_{nom}$  range. To limit these issues, the system designer must consider the worst case grid voltage conditions and wiring run lengths between the inverter to the point of common connection, and size wiring appropriately. For North America, based on ANSI B values, the worst case voltage range is  $\pm 6\%$  of  $V_{nom}$  and line voltage drop in this case should be limited to *less than* 3% of  $V_{nom}$ . Lower is better, so not to dissipate harvested power as heat.

## Clamps terminal use

All power conductors will be inserted in spring clamp terminals.

The figure shows an example of how to make the wires connection:

- Insert a small flat screwdriver in the slot and lightly press the screwdriver from top to bottom; insert the screwdriver until the spring opens.
- Insert the cable in the spring clamp.
- Remove the screwdriver.
- When connections are complete, give each wire a pull test

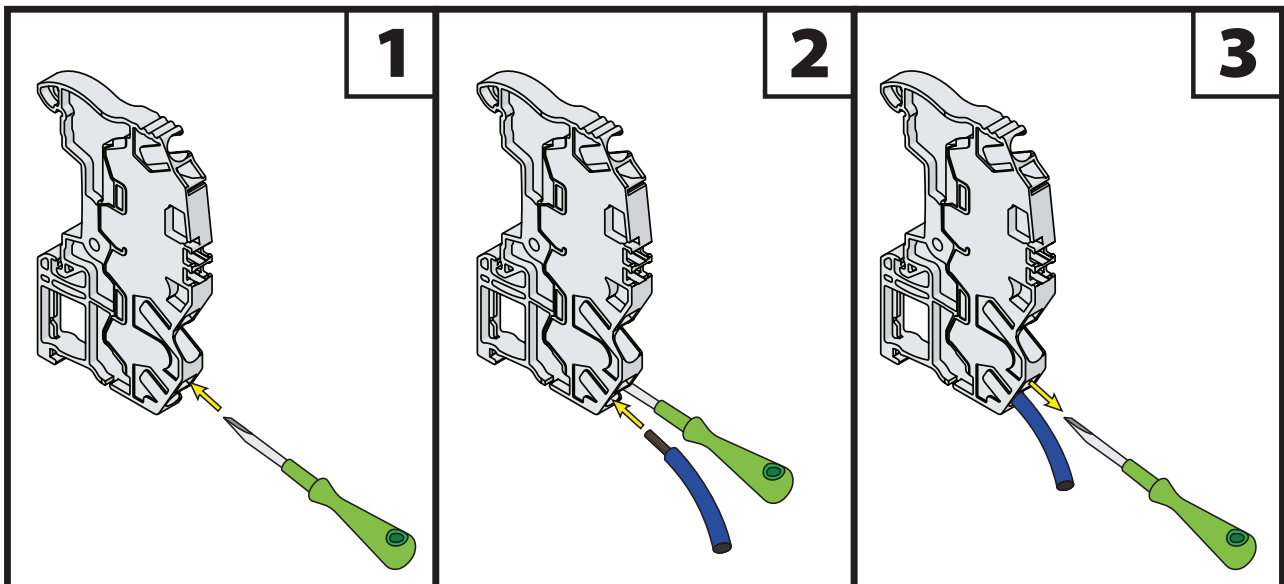



## Preliminary operations for connection of the PV generator

### Independent or parallel input channels configuration

The inverter is equipped with two input channels (thus benefiting from two trackers for MPPT maximum power point tracking) which work independently of one another, which can be paralleled by leveraging a single MPPT.

Strings of photovoltaic modules having the same type and number of panels in series must be connected to each single channel; they must also have the same installation conditions (in terms of orientation to the SOUTH and inclination from the horizontal plane).

When connecting the two input channels in parallel, you must comply with the above requirements in order to benefit from the ability to leverage the full power of the inverter output on a single channel.

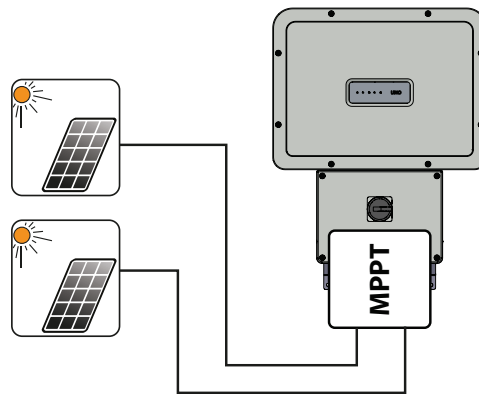

The dual MPPT structure however allows management of two photovoltaic generators which are independent of each other (one for each input channel), and which may differ between themselves with regard to installation conditions, type and number of photovoltaic modules connected in series. A necessary condition for the two MPPT to be used independently is that the photovoltaic generator connected to each of the inputs has a lower power than the power limit of the single input channel and a maximum current lower than the current limit of the single input channel.

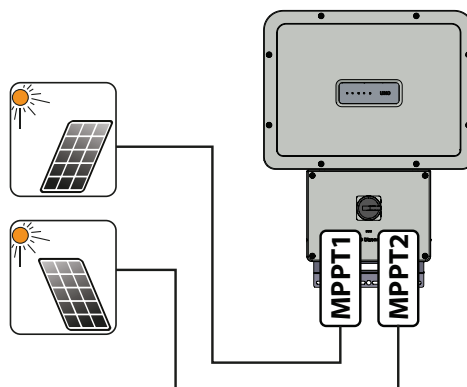

*All input parameters that must be met for correct inverter operation are shown in the "technical data" table.*



## Channel configuration examples

PV generator characteristics	MPPT configuration	Notes
<p>The photovoltaic generator consists of strings having a <b>different</b> number of modules in series from each other.</p> <p>The photovoltaic generator consists of strings that have <b>different</b> installation conditions from each other.</p>	<p><b>MPPT configuration has to be INDEPENDENT</b></p>	<p>A <b>NECESSARY</b> condition so that the two MPPTs can be used in independent mode is for the photovoltaic generator connected to each of the inputs to have a power <b>lower</b> than the power limit of the single input channel <b>AND</b> a maximum current <b>lower</b> than the current limit of the single input channel.</p>
<p>The photovoltaic generator consists of strings having the <b>same</b> number of modules in series as each other.</p> <p>The photovoltaic generator consists of strings that have the <b>same</b> installation conditions, that is to say, all the strings have the <b>same</b> inclination from the horizontal and the <b>same</b> orientation to the SOUTH.</p> <p>The photovoltaic generator connected to each of the inputs has a power <b>lower</b> than the power limit of the input channel <b>AND</b> a current <b>lower</b> than the current limit of the input channel.</p>	<p><b>Possibility of choosing between the configuration with MPPT as INDEPENDENT or PARALLEL</b></p>	<p>A <b>NECESSARY</b> condition so that the two MPPTs can be used in independent mode is for the photovoltaic generator connected to each of the inputs to have a power <b>lower</b> than the power limit of the input channel <b>AND</b> a maximum current <b>lower</b> than the current limit of the input channel.</p> <p>An <b>ADVISABLE</b> (*) condition so that the two MPPTs can be connected in parallel is for the photovoltaic generator connected to the two inputs to consist of strings made by the <b>same</b> number of modules in series and for all the modules to have the <b>same</b> installation conditions.</p>
<p><i>(*) This condition is advisable from the point of view of the energy production of the system, not from the point of view of inverter operation.</i></p>		
<p>The photovoltaic generator consists of strings having the <b>same</b> number of modules in series as each other.</p> <p>The photovoltaic generator consists of strings that have the <b>same</b> installation conditions, that is to say, all the strings have the <b>same</b> inclination from the horizontal and the <b>same</b> orientation to the SOUTH.</p> <p>The photovoltaic generator connected to each of the inputs has a power <b>higher</b> than the power limit of the input channel <b>OR</b> a current <b>higher</b> than the current limit of the input channel.</p>	<p><b>MPPT configuration has to be PARALLEL</b></p>	<p>A <b>SUFFICIENT</b> (*) condition so that the two MPPTs must be used in parallel mode is for the photovoltaic generator connected to each of the inputs to have a power <b>higher</b> than the power limit of the single input channel <b>OR</b> a maximum current <b>higher</b> than the current limit of the single input channel.</p> <p>An <b>ADVISABLE</b> (**) condition so that the two MPPTs can be connected in parallel is for the photovoltaic generator connected to the two inputs to consist of strings made by the same number of modules in series and for all the modules to have the same installation conditions.</p>
<p><i>(*) This condition is sufficient from the point of view of the energy production of the system, not from the point of view of inverter operation.</i></p>		
<p><i>(**) This condition is advisable from the point of view of the energy production of the system, not from the point of view of inverter operation.</i></p>		

## Independent channel configuration (default configuration)

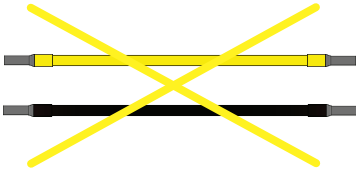

This configuration is set at the factory and involves the use of the two input channels (MPPT) in an independent mode. This means that the jumpers (supplied) between the positive and negative poles of the two DC input channels **12** must not be installed, and that the “independent” channel mode should be set during the commissioning phase via internal webserver (step 4).

## Parallel channel configuration



This configuration involves the use of the two input channels (MPPT) connected in parallel. This means that the jumpers (supplied) between the positive and negative poles of the two DC input channels **12** must be installed, and that the “parallel” channel mode should be set during the commissioning phase via internal webserver (step 4).

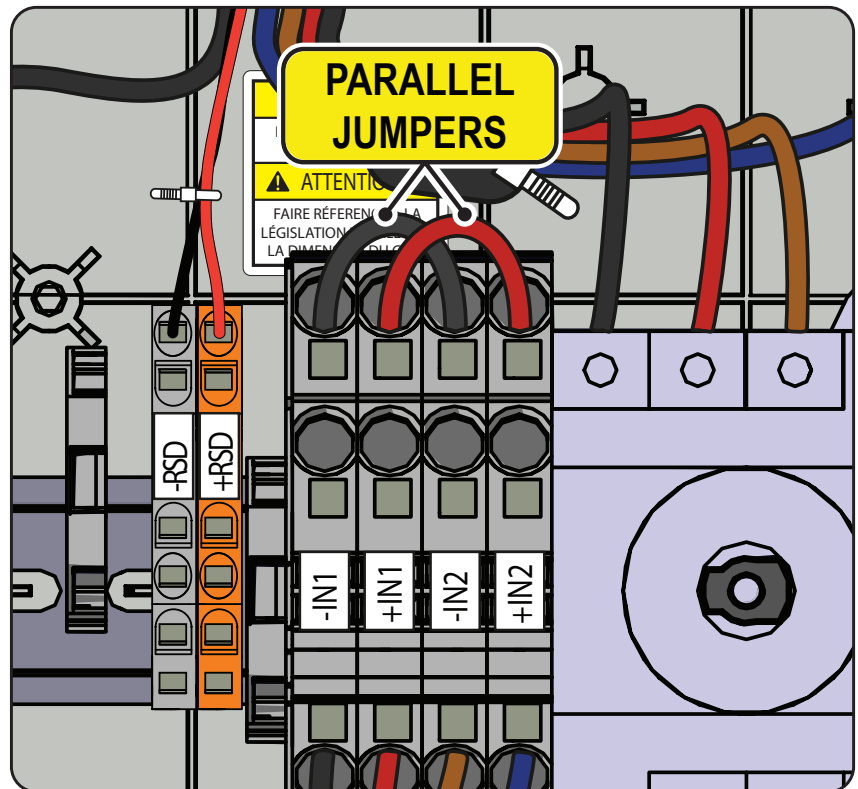

## Checking the correct polarity of the strings

Using a voltmeter, check that the voltage of each string has the correct polarity and falls within the input voltage limits of the inverter (see technical data).



*Polarity inversion can cause serious damage.*

If the open circuit voltage of the string is near the maximum value accepted by the inverter, consider that low ambient temperatures cause an increase in the string voltage (different according to the photovoltaic module used). In this case it is necessary to carry out a check of the sizing of the system and/or a check on the connections of the modules of the system (e.g.: number of modules in series higher than the design number).

## Checking of leakage to ground of the photovoltaic generator

Measure the voltage present between the positive and negative pole of each string with respect to ground.

If a voltage is measured between an input pole and ground, it may be that there is a low insulation resistance of the photovoltaic generator and the installer will have to carry out a check to solve the problem.



*Do not connect the strings if a leakage to ground has been detected, as the inverter might not connect to the grid.*

## Electrical connection to the PV field - DC side

After having carried out preliminary checks and therefore having verified that there are no problems in the photovoltaic system, and the channel configuration has been selected (parallel or independent) you may connect the inputs to the inverter.

*Confirm the correct polarity in the input strings.*

*Confirm there is no ground leakage current in the PV array.*

*When exposed to sunlight, the PV panels supply DC direct voltage to the inverter.*

*The inverter's DC switch disconnects the DC current from the PV panels. In the "OFF" position the inverter will stop producing power, but DOES NOT disconnect the AC from the grid. To prevent electrocution hazards, all the connection operations must be carried out with the external AC disconnect switch, downstream of the inverter (grid side), open and locked out.*



*The transformerless design requires that the PV array to be floating with respect to ground per NEC 690.35.*

*DC PV string wire must be UL-listed wire per NEC 690.35 with rated minimum 600V.*

*PV output conductors (wiring) must consist of sheathed (jacketed) multi-conductor cables or single insulated conductors (wires) which must be installed in an approved raceway. These conductors must be isolated from the enclosure and system grounding, as required by NEC 690.35. This is the responsibility of the installer.*



*Confirm that the maximum PV array short circuit current for each DC input channel is within the inverter specification. Array equipment grounding must be installed per the requirements of the NEC and is the responsibility of the installer. A configuration program that can help to correctly size the photovoltaic system is available on at <http://www.stringsizer.fimer.com>.*



- Turn the DC switch OFF
- Loosen the four captive screws on the wiring box cover (Torx 20) and remove the cover
- Remove the threaded plastic plug and nut from the DC cable opening ⑬.
- Insert the appropriate water-tight conduit connector and tighten to the chassis to maintain NEMA 4X compliance.

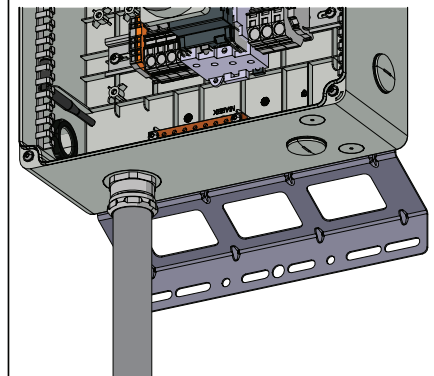
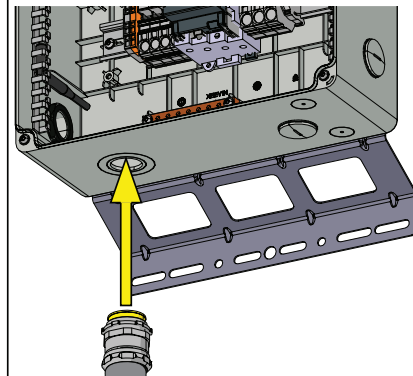
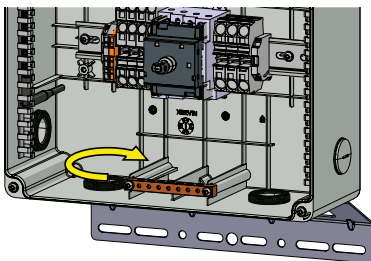

- Run the DC wires through the openings dedicated to the DC conduit.

*Conduit must be sealed using water-tight fittings to maintain NEMA Type 4X enclosure integrity.*

- Connect the DC wiring to DC input terminal blocks ⑫. DC wiring terminals



are spring pressure type and accommodate a wire size range of 20-8AWG. Connect the strings in either independent or parallel mode, following the appropriate set of instructions below:

**DC connection with INDEPENDENT MPPT configuration**

If two PV arrays with each be below the maximum input current rating of the inverter, they may be connected as “IND” array, each with its own MPPT. In this case, do nothing with the jumper wires which came with the inverters.

- Connect the positive side of the first PV array to +IN1, and its negative side to -IN1.
- Connect the positive side of the second PV array to +IN2 and its negative side to -IN2. Up to four strings can be connected in independent mode.
- During commissioning, confirm that the input mode is set to IND.

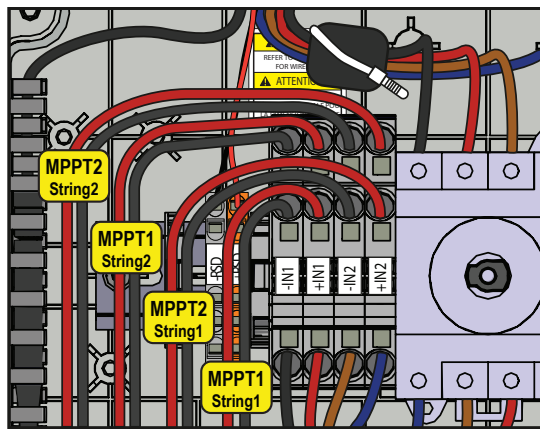

**DC connection with PARALLEL MPPT configuration**

If a PV array’s output current is more than the rating for a single inverter channel:

- Connect the red jumper wire between the +IN1 and +IN2 terminal block inputs. Then connect the jumper wire black wire between the -IN1 and -IN2 terminals. Remember channel mode should be set during the commissioning phase via internal webserver (step 4).
- Connect the array to the IN1 (MPPT1) and IN2 (MPPT2) input positions, running separate wires for positive (+) and negative (-) for each array.

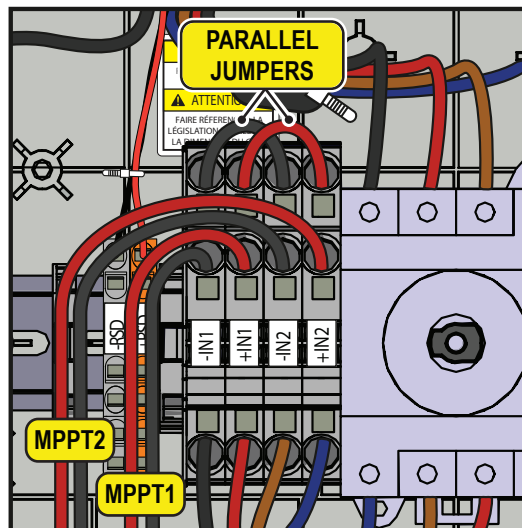

## Grid output connection (AC side)



Wire must be sized based on ampacity requirements of the NEC or other applicable prevailing code.

To prevent electrocution hazards, all the connection operations must be carried out with the external AC disconnect switch downstream of the inverter (grid side) open and locked out.



Any failure of the inverter when it is not connected to ground through the appropriate terminal is not covered by the warranty.

AC grid wiring is based on the grid standard shown in the utility configuration table below.

GRID STANDARD TYPE DE RÉSEAU	L1			L1		
	L3			N		
	208V~ 3PH - Δ			240V~ SPLIT-PHASE		
TERMINAL BORNE	1	2	3	1	2	3
WIRE CÂBLE	L1	L2	-	L1	L2	N

### Connection to AC terminal block

- Run an approved raceway between inverter and external AC OCPD.
- Remove the threaded plastic plug and nut from the AC cable opening 14.
- Insert the appropriate water-tight conduit connector and tighten to the chassis to maintain NEMA 4X compliance.

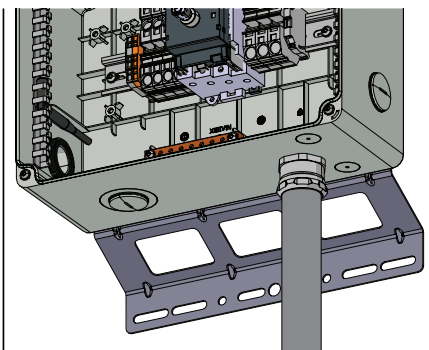
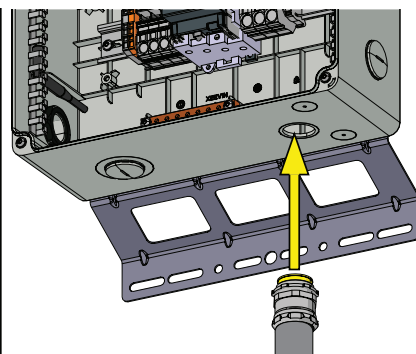
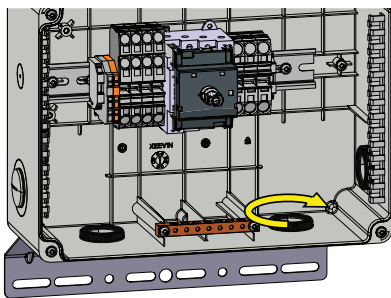

- Make appropriate conduit runs from grid and pull the AC conductors through the raceway to the inverter.



Conduit must be sealed using water-tight fittings to maintain NEMA Type 4X enclosure integrity.

- Connect the conductors to the correct terminals on the AC output terminal block 10 (wire size range of 20-6 AWG) based on the AC grid standard used in the table above.

- Connect the main AC ground cable in the raceway to protective earth (PE) connection point 19.



*If several inverters are installed to a three-phase AC GRID, always distribute the inverters between the phases in order to reduce power imbalance between the phases. Always refer to the local standards.*

### **Grid standard setting of the country**

In addition to the selection of grid voltages based on the installation site, grid parameters may be dictated by the utility company or authority having jurisdiction according to the country in which the inverter is installed.

The selection of the country standard must be done during commissioning wizard phase. See dedicated paragraph on Chapter 7.



## Rapid Shutdown (RSD) connection

The installer must use an external rapid shutdown device compliant with the 2014 NEC.

Automatic shutdown occurs at the rooftop box when utility power is lost or when the PV system's AC disconnect switch is opened. In jurisdictions requiring a dedicated activation switch, install an emergency stop button external to the inverter.

The wiring box has 24Vdc (0.4A max) on a spring-loaded terminal block to the left of the PV input area, which is designed to be used to power a RSD device.

RSD wiring terminals accommodate a wire size range of 26-12 AWG.

- Install RSD device wires in the RSD terminal block;
- +24V wire to +RSD terminal,
- 24V wire to - RSD terminal

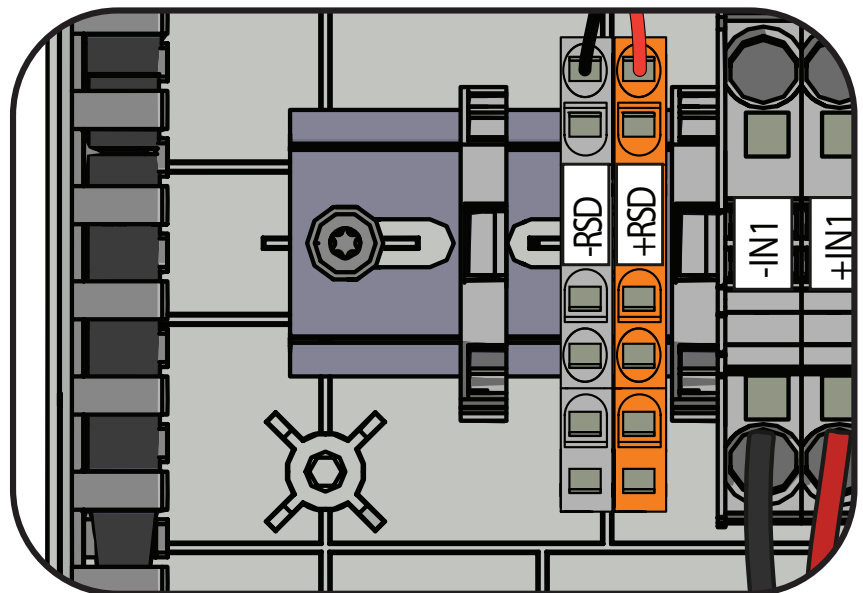

*NOTE: If a RSD device was installed into the plant, it also will need to be connected to the AC grid to allow the inverter to power-up!*

## Communication and control signal connections to the accessory UNO-DM-COM KIT board

To connect the signal cables to the UNO-DM-COM KIT or UNO-DM-PLUS-Ethernet COM KIT board is necessary to:

- Remove both front covers (wiring box 05 and inverter compartment 04)
- Insert the appropriate water-tight conduit connector on signal conduit opening 15 and tighten to the chassis to maintain NEMA 4X compliance. *Conduit must be sealed using water-tight fittings to maintain NEMA Type 4X enclosure integrity.*
- Run the cables through the signal cable conduit
- Run the cables through the plastic cable tray on the internal right side of the wiring box
- Run the cables through the specific cable conduit present on the plastic shield of the mainboard.

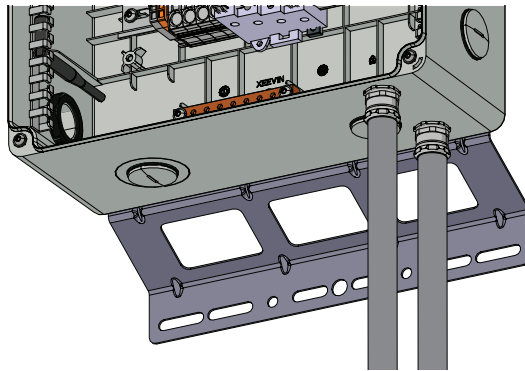
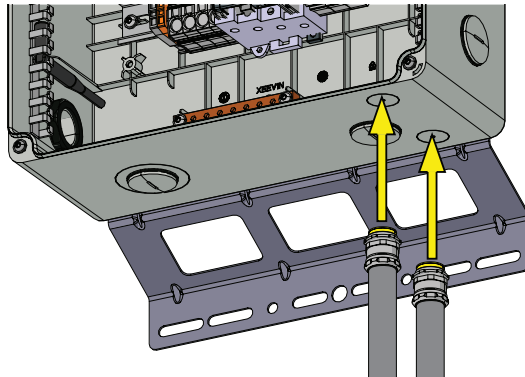
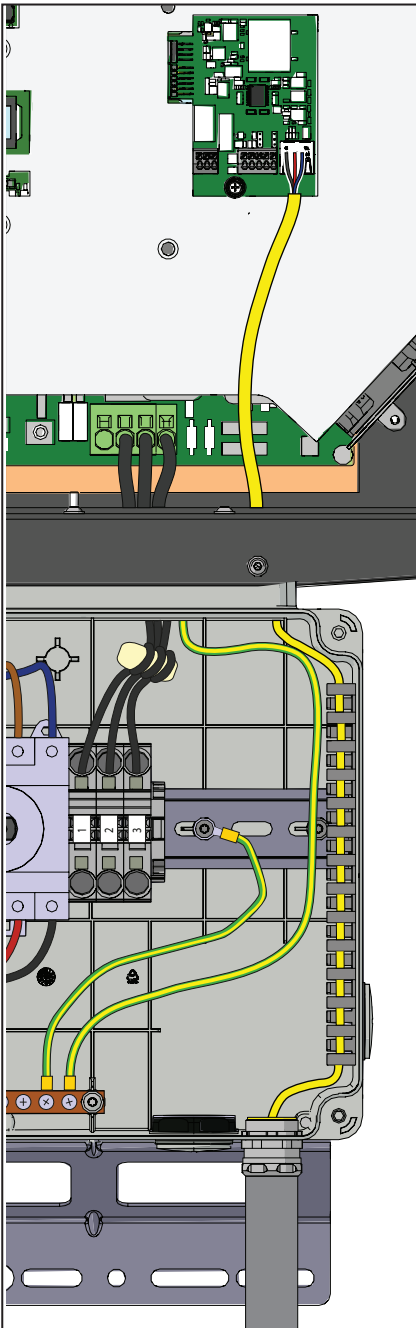

The connection of the wires to the terminals is performed as follows:

1. Press and hold the button corresponding to the terminal where the wire is to be connected
2. Insert the cable
3. Release the button
4. Pull the wire to check the tightness.

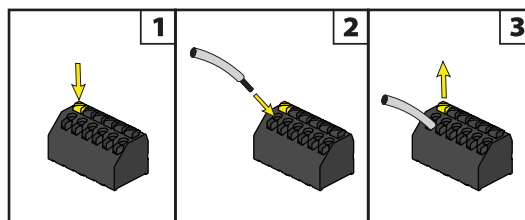

Description of terminal blocks on the UNO-DM-COM KIT board

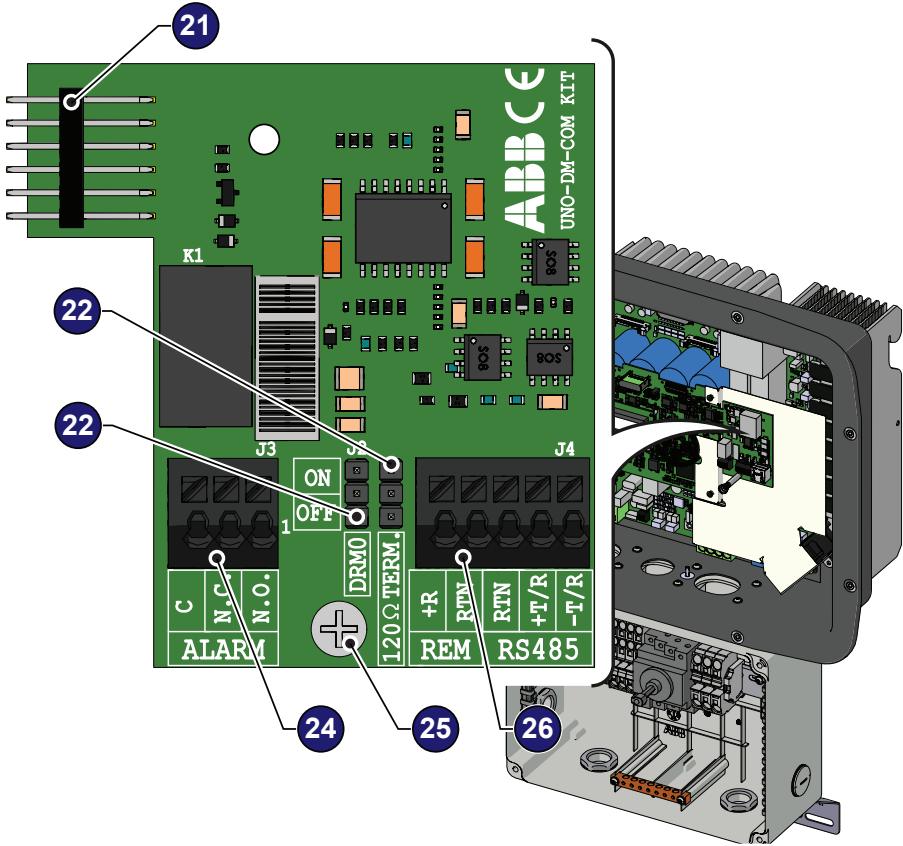

Description of multifunctional relay terminal block 24:

Terminal name	Terminal number	Description
ALARM	N.C.	"Normally closed" terminal of multifunctional relay
	C	"Common" terminal of multifunctional relay
	N.O.	"Normally open" terminal of multifunctional relay

Description of communication and control signal terminal block 26:

Terminal name	Terminal number	Description
REM	+R	Remote external ON/OFF command
	RTN	Reference (RTN) of the Remote external ON/OFF command
RS485	RTN	Reference (RTN) of the RS485 communication line
	+T/R	+T/R of the RS485 communication line
	-T/R	-T/R of the RS485 communication line

## Description of terminal blocks on the UNO-DM-PLUS-Ethernet COM KIT board

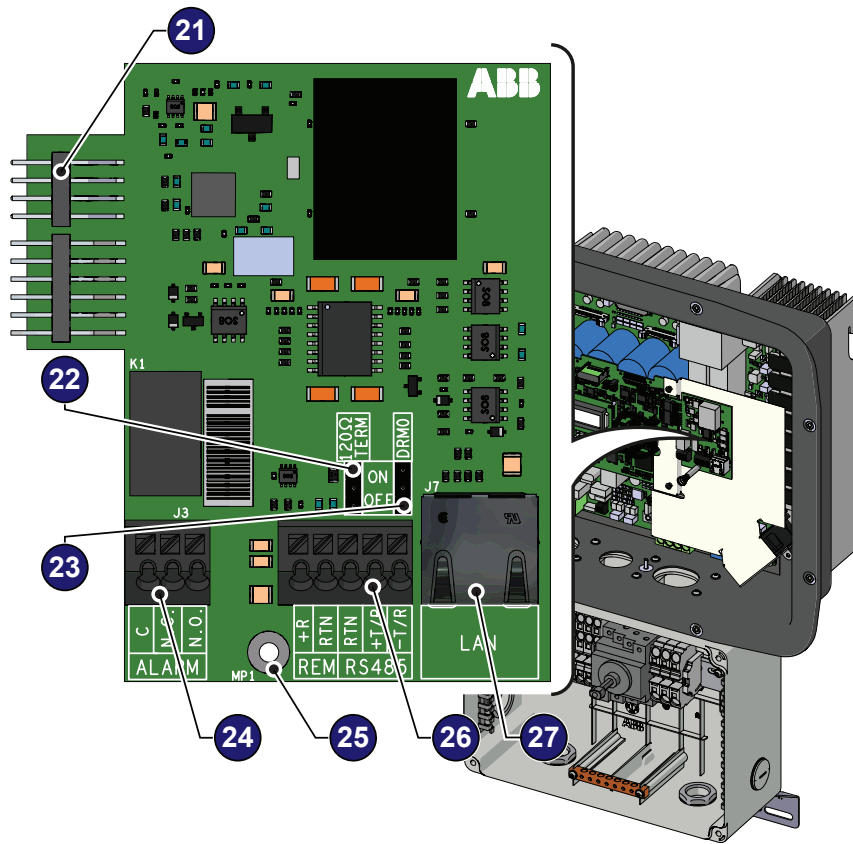

Description of multifunctional relay terminal block <sup>24</sup>:

Terminal name	Terminal number	Description
ALARM	N.C.	"Normally closed" terminal of multifunctional relay
	C	"Common" terminal of multifunctional relay
	N.O.	"Normally open" terminal of multifunctional relay

Description of communication and control signal terminal block <sup>26</sup>:

Terminal name	Terminal number	Description
REM	+R	Remote external ON/OFF command
	RTN	Reference (RTN) of the Remote external ON/OFF command
RS485	RTN	Reference (RTN) of the RS485 communication line
	+T/R	+T/R of the RS485 communication line
	-T/R	-T/R of the RS485 communication line

## Connection of the RS485 line

On the inverter models which equip the UNO-DM-COM KIT or UNO-DM-PLUS-Ethernet COM KIT board it is possible to use the RS485 communication port for: Integrating the inverter with a third party monitoring and control systems; Carrying out “daisy-chain” (“in-out”) connections of multiple inverters installation; Setting internal inverter parameters with the dedicated advanced configuration software “Aurora Manager Lite”.



The inverter RS485 communication protocol must be properly configured depending on the device to which it communicates. The RS485 protocol can be changed through the relevant section of internal webserver (see the specific chapter).

The connection of the serial communication cable must be made to the specific RS485 connector <sup>26</sup> present on the UNO-DM-COM KIT board.

For connection of the RS485 communication line is necessary a three-wire shielded cable. The cable specifications are described in the following table:

Cable type	AWG	Characteristic impedance	Operating voltage	Operating temperature
Shielded	22 - 24	120 Ohm	≥300 V	-20...+60 °C

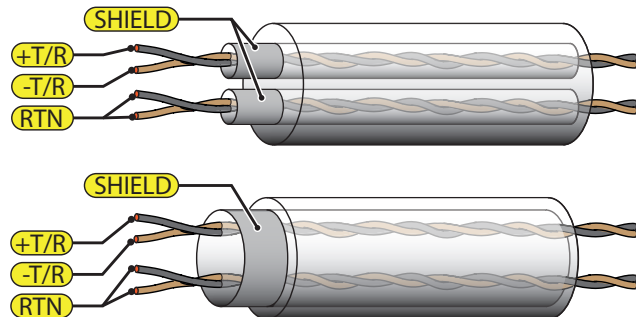

Shield continuity must be provided along the communication line and must be grounded at a single point. It is recommended not to exceed a length of 1000m for the communication line.



The cabling of the RS485 line must be wound up to the toroidal provided in the package (1 winding); this toroidal shall be conveniently placed near the cable gland which is in the bottom part of the inverter.

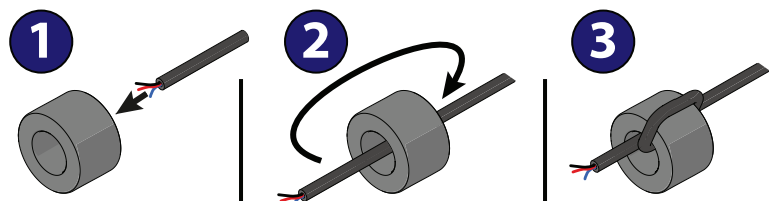

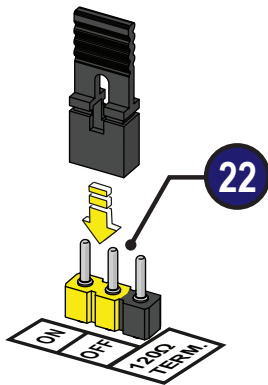

The RS485 HALF-DUPLEX communication line is made up of two transmission and reception cables (+T/R and -T/R) and a communication reference cable (RTN): all three cables must be connected in daisy-chain configuration (it's recommended to make connection external to the inverter).

The RS485 connection can be made by using the terminal block 26.

The last inverter of a daisy chain shall be terminated: within the last inverter itself the provided jumper at the pins marked "120Ohm TERM." shall be placed in ON position in order to enable the termination the RS485 communication line 22 with a resistance present onboard.

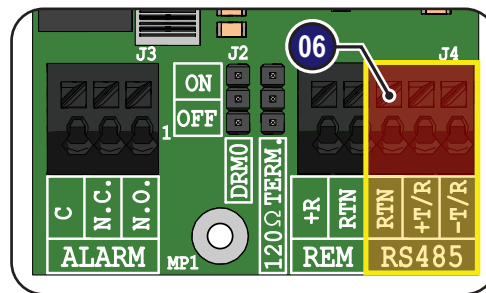

After the connection is completed RS485 inverter address have to be chosen between 1 and 63.

The setting of the address on the inverter is done through the relevant section of internal webserver (see the specific chapter) or through the display and the keyboard (see the specific chapter).

Each inverter is supplied with the preset RS485 address "2" and with the jumper termination resistance 22 in the OFF position.

## Remote control connection

The connection and disconnection of the inverter to and from the grid can be controlled through an external control.

The function must be enabled in the specific section of internal webserver (see the specific chapter). If the remote control function is disabled, the switching on of the inverter is dictated by the presence of the normal parameters that allow the inverter to connect to the grid. If the remote control function is operating, besides being dictated by the presence of the normal parameters that allow the inverter to connect to the grid, start-up of the inverter also depends on the state of the terminal **R+** compared to the terminal **RTN** present on the connector **26**.

When the **R+** signal is brought to the same potential as the **RTN** signal (that is to say when a short-circuit is created between the two connector terminals), the inverter is disconnected from the grid.

Connections for this command are made between input “**R+**” and “**RTN**”.

Since this is a digital input, there are no requirements to be observed as regards cable cross-section (it only needs to comply with the sizing requirement for passing cables through the cable glands **20** and the terminal connector **26**). The cable specifications are described in the following table:

AWG	Operating voltage	Operating temperature
22 - 24	≥300 V	-20...+60 °C

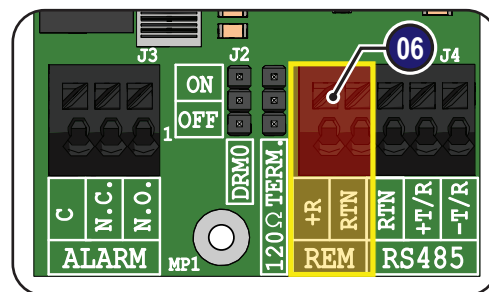

## Demand Response Mode 0 (Request by AS/NZS 4777)

Where requested by the AS/NZS 4777 standard, it's possible to use the REM terminal block **26** for the Demand Response Mode 0 (DRM0) functionality. The function could be activated by placing the provided jumper **23** in “ON” position.

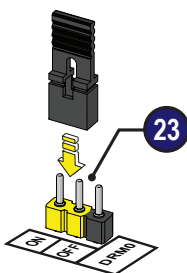

*In case of the DRM0 function is activated without the proper wiring of the REM terminal block **26**, the inverter will no longer be able to connect to the grid. For further information regarding the DRM0 function refer to the AS/NZS 4777 standard.*

## Configurable Relay connection (ALARM / LOAD MANAGER)

The UNO-DM-COM KIT or UNO-DM-PLUS-Ethernet COM KIT boards is equipped with a relay with configurable activation that allows connection of external devices which for example, signal malfunctions to manage loads with a specific configurable power input threshold, according to the mode selected in the specific section of internal webserver (see the specific chapter). The connection must be made to the specific ALARM terminal block 24.

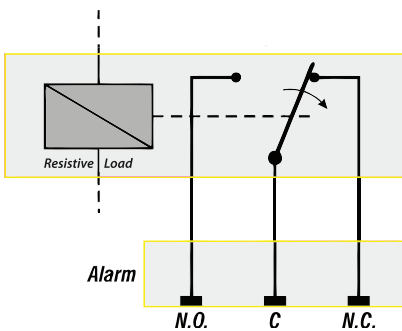
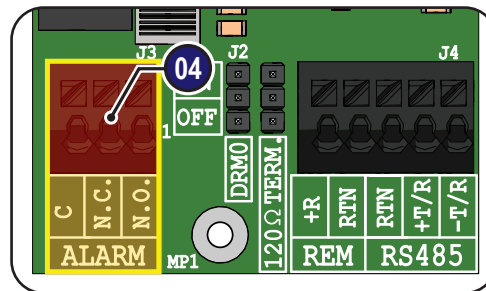

The configurable relay can be used with normally open contact (being connected between the NO terminal and the common contact C) and with normally closed contact (being connected between the NC terminal and the common contact C).

Different types of devices (light, sound, etc.) can be connected to the relay, provided they comply with the following requirements:

### Relay Rating:

Maximum Voltage: 240 Vac

Maximum Current: 1 A

The cable specifications are described in the following table:

AWG	Operating voltage	Operating temperature
22 - 24	≥300 V	-20...+60 °C

This contact can be used in different operating configurations that can be selected by accessing the specific section of internal webserver (refer to the specific chapter)



## Closing the front cover

At the end of the inverter connection and configuration stage and before proceeding with the commissioning, the inverter's covers **04** and the wiring box covers **05** must be closed.

*During the installation of the cover, the installation sequence must be respected as well as the tightening torque of the screws (set out in the paragraph on technical data) in order to maintain NEMA Type 4X enclosure integrity.*

- Insert and screw in the fixing screws.
- Tighten the screws respecting the sequence and the tightening torque (2.5 Nm / 1.8 ft-lb).

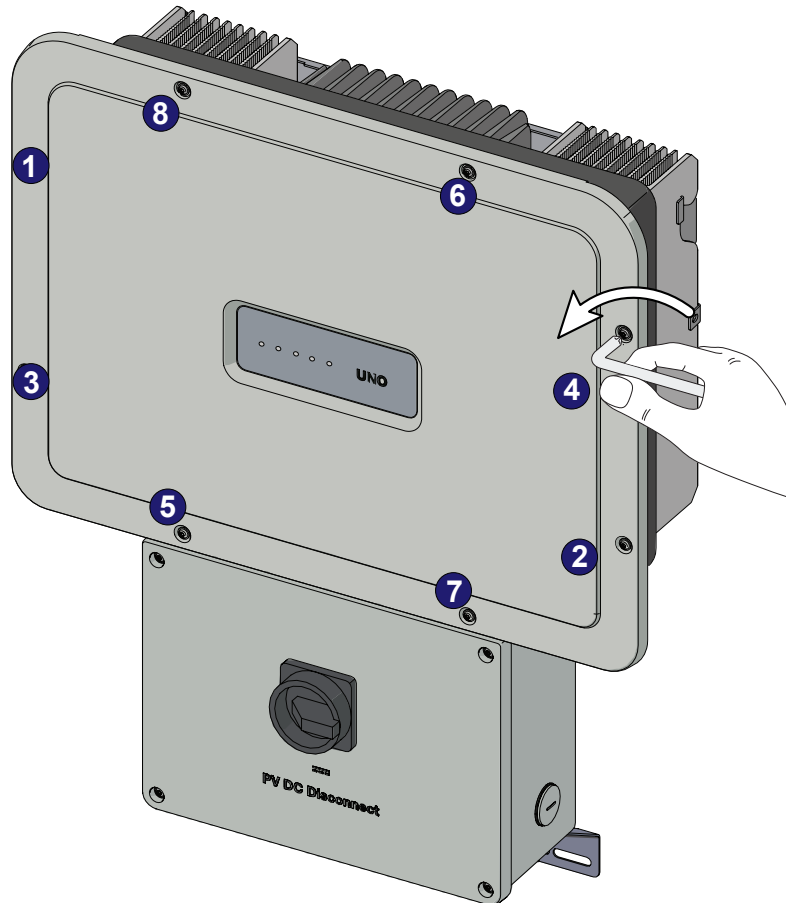

After having installed the front cover, it is possible to proceed with the commissioning of the inverter.

To prevent damage to the equipment and to the operator is to have a thorough knowledge of the inverter instruments. We, therefore, advise to carefully read this manual; in case of uncertainty on the information to request more detailed information.

*The FIMER solar inverter help desk may be reached at 1-877-261-1374, 6am - 6pm (PST) Monday-Friday. excluding major holidays.*



*Do not use the inverter or the PV plant if the operator:*

- is not trained or qualified to work on this PV plant;*
- does not understand how the system works;*
- is not sure what will happen when the buttons or switches are operated;*
- notices any operating anomalies;*
- has doubts based on his/her experience, the product manual and/or information from other operators.*

FIMER cannot be held responsible for damage to the equipment or the operator resulting from lack of knowledge, insufficient qualifications or lack of training.

## Description LED Panel

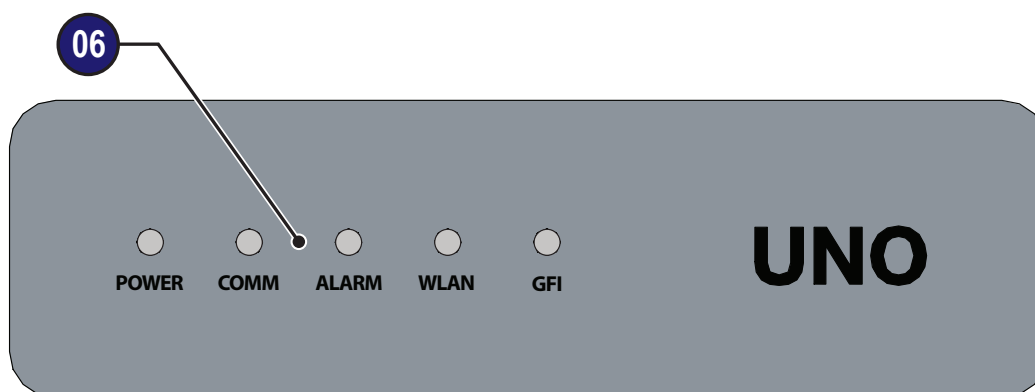

### LEDs <sup>06</sup>

<b>POWER</b>	<b>Green</b>	Solid when the inverter is working correctly. Flashes when checking the grid or if there is insufficient sunlight.
<b>COMM STATUS</b>	<b>Multi-color</b>	Operation status of wireless communication line: <ul style="list-style-type: none"> <li>- <b>Blink Red</b>: Communication error (no communication available)</li> <li>- <b>Green</b>: Communication OK</li> </ul>
<b>ALARM</b>	<b>Yellow</b>	The inverter has detected an anomaly. The anomaly is shown on the "EVENTS" section of the internal webserver.
<b>WLAN</b>	<b>Multi-color</b>	Communication type and quality of the wireless communication signal (for "Station Mode"): <ul style="list-style-type: none"> <li>- <b>Blink Blue</b>: Wireless board is working in Access Point mode (AP Mode)</li> <li>- <b>OFF</b>: No signal</li> <li>- <b>Blink Red</b>: Low signal strength</li> <li>- <b>Blink Yellow</b>: Medium signal strength</li> <li>- <b>Blink Green</b>: High signal strength</li> </ul>
<b>GFI</b>	<b>Red</b>	Ground fault on the DC side of the PV generator. The error is shown on the "EVENTS" section of the internal webserver.

*The LEDs, in various multiple available combinations, can signal multiple conditions other than the original single condition; see the various descriptions explained in the manual.*

## Introduction and operation warnings

Before commissioning the inverter, it is necessary to have a thorough knowledge of the Instruments chapter 6 and the functions that is possible to enable in the commissioning phase.

When the inverter is commissioned operates automatically without the aid of an operator; the operating state should be controlled through the equipment's instrumentation (LED's, internal Webserver).



*The input voltage must not exceed the maximum values shown in the technical data, section 2 in order to avoid damaging the equipment.*

## Monitoring and data transmission

### User interface

The inverter is able to provide information about its operation through the following instruments:

- Warning lights (luminous LEDs)
- Mobile app and webserver
- Data transmission on the dedicated RS-485 serial line. The data can be collected by a PC or a data logger equipped with an RS-485 port. Contact the FIMER support service with any queries about device compatibility.

### Measurement tolerance

The data supplied by the inverter may differ from measurements taken by certified measuring instruments (e.g. output meters, multimeters and grid analysers); since the inverter is not a measuring instrument it has wider tolerances for the measurements it makes.

The tolerances are generally:

- ±5% for real-time measurements with output power below 20%
- ±3% for real-time measurements with output power above 20%
- ±4% for all statistical data.

## Commissioning (Via internal Webserver)



*Do not place objects of any kind on the inverter during operation! Do not touch the heat sink while the inverter is operating! Some parts may be very hot and could cause burns.*



*Before proceeding with commissioning, make sure you have carried out all the checks and verifications indicated in the section on preliminary checks.*



*The screenshots shown in this chapter are indicatives and it could be changed without any notification.*

Commissioning could be carried out via wireless connection to the inverter's internal webserver. Initial setup of the system must therefore be carried out via a tablet, notebook or smartphone with a wireless connection.

- Close the DC disconnect switch to supply the inverter with input voltage from the photovoltaic generator.



*The inverter is powered SOLELY by the voltage generated by the photovoltaic generator: the presence of grid voltage alone is NOT SUFFICIENT for the inverter to switch on.*



*NOTE: If a RSD device was installed into the plant, it also will needed to connect the AC grid to allow the inverter to power-up!*



*Make sure irradiation is stable and adequate for the inverter commissioning procedure to be completed.*

- Set the external AC disconnect switch downstream to the inverter to "ON" position.
- Once powered, the inverter will automatically create a wireless network (approx. 60 seconds after its switch-on) that will be visible as an Access Point from the user devices previously mentioned (tablet, smartphone, etc.).
- Enable the wireless connection on the device which is being used for the board setup (tablet, smartphone or PC) and connect it to the Access Point created by the inverter system: the name of the wireless network created by the system that the connection should be established with, will be:

**ABB-XX-XX-XX-XX-XX-XX**

where "X" is a hex digit of the wireless MAC address (MAC address can be found on the "Wireless Identification Label" placed on the side of the inverter or applied during the commissioning phase to the quick installation guide on cover page).



*The screens shown below pertain to a tablet with the Android operating system. Screens on other devices or operating systems may differ.*



- When required digit the network password **FIMERSOLAR**



After 24 hours wick the inverter is power-on, the access point default password “FIMERSOLAR” will be disabled and any subsequent access to the internal webserver will be possible only using the **PRODUCT KEY** (printed on the “Wireless identification label” and applied during the commissioning phase to the quick installation guide on cover page) as access point password.

- Open an internet browser (reccomended browser: Chrome versions from v.55, Firefox versions from v.50) and enter the pre-set IP address **192.168.117.1** to access the setup pages (web user interface).  
A guided setup procedure will open that will enable you to impose the necessary settings for correct commissioning of the inverter.



The language of the wizard could be changed by clicking on the upper status bar

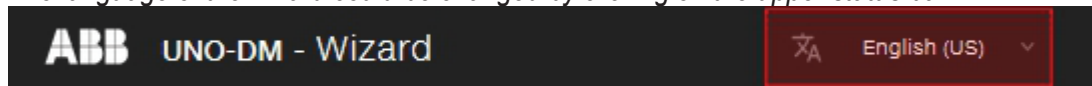

The required informations during the procedure are:

#### STEP 1 - Administrator/User login credentials

### Administrator account

Admin ⓘ

Username

Required

Password ⓘ

Password

Required

Confirm Password ⓘ

Re-enter Password

Required

### User account

User ⓘ

Username

Required

No user password

NEXT

- Set the **Administrator** account user and password (minimum 8 character for password):  
Administrator account can open and view the contents of photovoltaic site. Additionally, they can make changes to inverter settings. User and password are CASE SENSITIVE.
- Set the **User** account user and (optional) password (minimum 8 character for password):  
User account can only read data. It cannot make any changes. User and password are CASE SENSITIVE.

**STEP 2 (Optional) - Residential wireless network connection.**

The inverter WLAN board can operate in two different operating modes: “Station Mode” or “Access Point Mode” (also known as “AP Mode”)

- “AP mode”: Only local communication is enabled in this mode; In particular, the WLAN board acts like an «access point» generating a wireless network to which the user can connect locally, to monitor or configure the inverter / photovoltaic system, using the direct access to the Internal Webserver integrated in the WLAN board

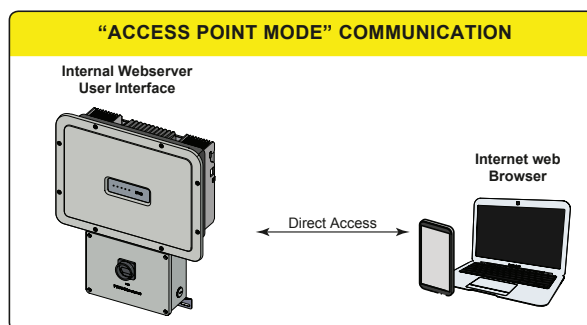

- “Station Mode”: In this operating mode, not only local but also remote monitoring is enabled through access to the LAN connection or through the Aurora Vision® CLOUD platform.

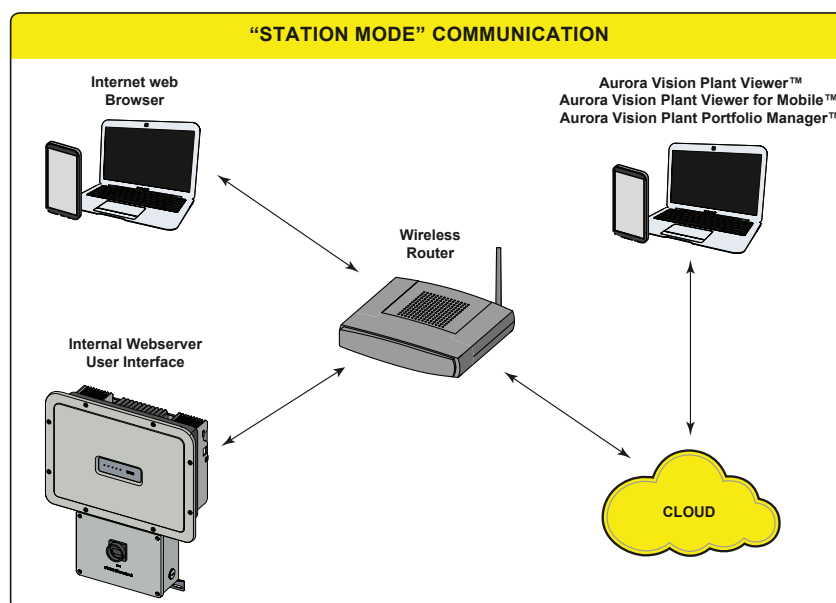

Where possible, “Station Mode” is always preferable. Thanks to the internet connection, this mode ensures better operation.

This setup stage relates to connecting the inverter to the own residential wireless network.

If it is not possible to connect the inverter to the wireless network, or you do not want to do so, select the “Skip this step” button. In this situation, communication between the inverter and the tablet/smartphone/PC will continue to be point to point (“AP Mode”).



**Wireless Network**

Skip this step

IP Settings  
DHCP

Available Network (SSID)  
-- Please select --

Required

Password

Show password

CONNECT

The parameters relating to the home wireless network (set on the router) that must be known and set during this step are:

- IP Settings: DHCP or Static.

If you select the DHCP function (default setup) the router will automatically assign a dynamic IP address to the inverter whenever it tries to connect to the user network.

With Static, the user can assign a fixed IP address to the system. The data which has to be entered in order for IP static address assigning to take place will appear. Complete the additional fields at the bottom of the screen (all the fields are mandatory with the exception of the secondary DNS server).

- Available networks (SSID):

Identify and select your own (home) wireless network from all those shown in the SSID field (you can carry out a new search of the networks that can be detected with the Update button ).

Once the network has been selected, confirm.

- Password: Wireless network password.

Enter the password for the destination network (if necessary) and start the connection attempt (it will take a few seconds).

Click on “Connect” button to switch the inverter wireless connection from point to point to the home wireless network.

**Wireless network connection:**

**Home\_Network**

The inverter is going to be connected to the wireless network **Home\_Network**

On-going attempt to connect to the wireless network **Home\_Network**

Back Next

A message will ask for confirmation. Click “Next” to connect the inverter to the home wireless network.

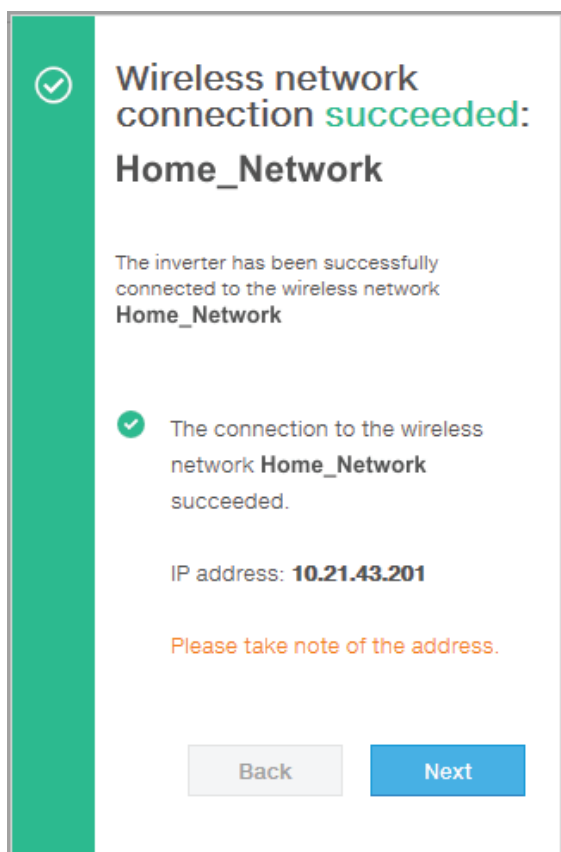

Once the inverter is connected to the domestic wireless network, a new message will confirm that the connection is acquired.

The message provides the IP Address assigned by the home wireless network router to the inverter that can be used each time you want to access the internal webserver, with the inverter connected to the home wireless network. **Take note of it.**

Click on “Next” button to proceed to the next stage of the configuration wizard.



*The IP address assigned may vary for reasons connected to the wireless home router setup (for example, a very brief DHCP lease time). If verification of the address is required, it is usually possible to obtain the client list (and the corresponding IP addresses) from the wireless router administration panel.*

If the inverter loses the connection with the home wireless network (and therefore, loses the internet connection), it will once again enable its own access point.



*The most common causes of losing connectivity might be: different wireless network password, faulty or unreachable router, replacement of router (different SSID) without the necessary setting updates.*

## STEP 3 - Date, Time and Time zone

### Date and Time

✔ Network Time Protocol server has been detected and it will be used to keep the system clock synchronized.

Date

Feb 22, 2017

SET by the NTP server

Time

3:28 PM

SET by the NTP server

Time Zone

Europe/Berlin GMT+01:00

BACK NEXT

Set the Date, Time and Time zone (The inverter will propose these fields when available).

### Date and Time

⊙ Network Time Protocol server has not been detected. Clock isn't synchronized. The displayed date and time come from the Inverter or have been manually set up.

Please set the correct system date and time if needed.

Date and time will be automatically updated as soon an NTP server is available.

Date

2/8/17

Time

11 : 56 AM

Time Zone

Europe/Berlin GMT+01:00

BACK NEXT

When it's not possible for the inverter to detect the time protocol, these fields have to be manually entered.

Click on "Next" button to proceed to the next stage of the configuration wizard.

## STEP 4 - Inverter country standard, Input configuration and Meter configuration

### - Country standard: selection of grid standard:

Set the grid standard of the country in which the inverter is installed.



From the moment that the grid standard is set, you have 24 hours to make any changes to the value, after which the “Country Select > Set Std.” functionality is blocked, and the remaining time will have to be reset in order to have the 24 hours of operation available again in which to select a new grid standard (follow the procedure “Resetting the remaining time for grid standard variation” described in the relevant section).



Any inverters installed, or commissioned, in California after September 8, 2017 must be set to the Rule 21 country code USA - RULE21 @ 240 single [R21 240sp] or USA - RULE21 @ 208 single [R21 208sj].

### Country standard

Grid Standard

-- Please select --

Required

### Input mode

PV Input Channels Configuration

Independent

### Meter

Meter Model

none

BACK

END

### - Input mode:

(See the relevant section of this manual to know how set the input mode)

1. **Independent**
2. **Parallel**

### - Meter:

Select None. No UL certified meter are available at the moment.

### Saving parameters

ⓘ After country standard is changed the inverter will be rebooted. The procedure may take several minutes. Please wait.

BACK

END

Confirm the settings by clicking “END” and it will reboot at the finish of test phase.

A notification will confirm that the wizard is completed.

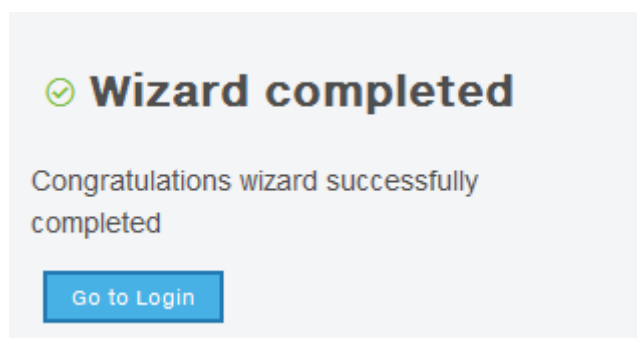

- - After the wizard is completed, the system will power-on. The inverter checks the grid voltage, measures the insulation resistance of the photovoltaic field with respect to ground and performs other auto-diagnostic checks. During the preliminary checks on the parallel connection with the grid, the “Power” LED keeps flashing, the “Alarm” and “GFI” LEDs are off.

Input voltage	LED Status	Description
$V_{in} < V_{start}$	Power = Flashing Alarm = OFF	The input voltage is not sufficient to enable connection to the grid.
$V_{in} > V_{start}$	Power = Flashing Alarm = ON	The input voltage is sufficient to enable connection to the grid: the inverter waits for the grid voltage to be present to make the parallel connection.



*The inverter is powered SOLELY by the voltage generated by the photovoltaic generator: the presence of grid voltage alone is NOT SUFFICIENT for the inverter to switch on.*

Once both AC and DC switches are closed and the wizard commissioning procedure is finished, the inverter starts the grid connection sequence: the inverter performs the grid voltage check, measures the PV array insulation resistance against earth and carries out other self-diagnosis checks. During the preliminary checks on the parallel connection with the grid, the “Power” LED keeps flashing, the “Alarm” and “GFI” LEDs are off.

- If the outcome of the preliminary checks on the grid parallel is positive, the inverter connects to the grid and starts to export power to the grid. The “Power” LED remains fixed on while the “Alarm” and “GFI” LEDs are off.









*To address any problems that may occur during the initial stages of operation of the system and to ensure the inverter remains fully functional, you are advised to check for any firmware updates in the download area of the website [www.fimer.com](http://www.fimer.com) (instructions for updating the firmware are given in this manual).*

































*According to CEC requirements the UNO-DM-3.3\_3.8\_4.6\_5.0-TL-PLUS-US-Q (no display models), display measured net generated energy and measured instantaneous power using a remote device like a smartphone, tablet or PC. Access it by connection to the inverter internal Webserver (please see the beginning of this paragraph on how to access to the internal webserver). In addition it is possible to use the mobile App ‘FIMER ability Energy Viewer for solar plants’ and the FIMER Web portal Aurora Vision (please refer to product manual for further details) to monitor all production data.*

## Power, Alarm, GFI LEDs behavior

The following table shows all the possible activation combinations of “Power” “Alarm” and “GFI” LEDs on the LED panel  according to the operating status of the inverter.

-  = LED On
-  = LED flashing slow (2 seconds on / 2 seconds off)
-  = LED flashing fast (0.2 seconds on / 0.2 seconds off)
-  = LED off
-  = Any one of the conditions described above

LED status	Operating state
Power:  Alarm:  GFI: 	<b>Firmware programming</b> The inverter firmware is being programmed
Power:  Alarm:  GFI: 	<b>Night mode (inverter automatically switches off)</b> The inverter is in night time switch-off mode (input voltage less than 70% of the set start-up voltage).
Power:  Alarm:  GFI: 	<b>Inverter initialisation</b> This is a transitional state due to the verification of the operating conditions. During this stage the inverter checks that the conditions for connecting to the grid are met.
Power:  Alarm:  GFI: 	<b>The inverter is connected and is feeding power into the grid</b> Normal operation. During this stage, the inverter automatically tracks and analyses the photovoltaic generator's maximum power point (MPP).
Power:  Alarm:  GFI: 	<b>Disconnection from the grid</b> Indicates no grid voltage. This condition does not allow the inverter to connect to the grid.
Power:  Alarm:  GFI: 	<b>Indication of Warning (W message codes) or Error (E message codes)</b> Indicates that the inverter control system has detected a warning (W) or error (E). See Alarm messages.
Power:  Alarm:  GFI: 	<ul style="list-style-type: none"> <li>• <b>Ventilation anomaly</b> Indicates an anomaly in the operation of the internal ventilation system that could limit output power at high ambient temperatures.</li> </ul>
	<ul style="list-style-type: none"> <li>• <b>Failed association of internal inverter components (after replacement)</b> Indicates that the installed wiring box (only in the event of a replacement) was already associated with another inverter and cannot be associated with the new inverter</li> </ul>
	<ul style="list-style-type: none"> <li>• <b>Overvoltage surge arresters triggered (where fitted)</b> Indicates that any class II overvoltage surge arresters installed on the AC or DC side have been triggered</li> </ul>
	<ul style="list-style-type: none"> <li>• <b>String protection fuses triggered (where fitted)</b> Indicates that one or more input string protection fuses that may be installed have been triggered</li> </ul>
	<ul style="list-style-type: none"> <li>• <b>Autotest (for Italian grid standards only)</b> The inverter is performing an Autotest</li> </ul>
Power:  Alarm:  GFI: 	<b>Anomaly in the insulation system of the photovoltaic generator</b> Indicates that a leakage to ground from the PV generator has been detected, causing the inverter to disconnect from the grid.

<b>Power:</b>		<b>DC arc fault detected during operation</b>
<b>Alarm:</b>		If a DC arc fault is detected during operation, the inverter disconnects from AC grid (the error code is readable through internal Webserver).
<b>GFI:</b>		
<b>Power:</b>		<b>AFD board self test failure</b>
<b>Alarm:</b>		Potential problem on the AFD board detected during self test phase
<b>GFI:</b>		

## COMM, WLAN LEDs behavior

The following table shows all the possible status of “COMM Status” and “RSSI” LEDs on the LED panel  according to the operating status of the wireless board.

LED	Description
<b>COMM STATUS (MULTICOLOR)</b>	<p>Operation status of wireless communication line:</p> <p><b>Blink Red:</b> Communication error (no communication available)</p> <p><b>Green:</b> Communication OK</p>
<b>WLAN (MULTICOLOR)</b>	<p>Communication type and quality of the wireless communication signal (for “Station Mode”):</p> <p><b>Blink Blue:</b> Wireless board is working in Access Point mode (AP Mode)</p> <p><b>OFF:</b> No signal</p> <p><b>Blink Red:</b> Low signal strength</p> <p><b>Blink Yellow:</b> Medium signal strength</p> <p><b>Blink Green:</b> High signal strength</p>

## Description of the internal Webserver

The UNO-DM-TL-PLUS inverters are equipped with an advanced integrated webserver and user interface that allow a full access to all configuration and commissioning parameters from any electronic device (laptop, tablet and smartphone).



*The screenshots shown in this chapter are indicatives and it could be changed without any notification.*

## Access to the internal Webserver

To access to the internal webserver is required to connect a device equipped with wireless connection (such as tablet, laptop or smartphone).

Depending on completion of STEP #2 of the wizard commissioning phase (the inverter was connected to the domestic wireless network (“Station Mode”), or this step was skipped) it’s required to follow one of the two procedures described below:

### Connection to the inverter in “Station Mode”

If the inverter was connected to the domestic wireless network, follow this procedures:

- Enable the wireless connection on the device (tablet, smartphone or laptop) and connect it to the same wireless network to which the inverter is connected.
- Open an internet browser (recommened browser: Chrome versions from v.55, Firefox versions from v.50) and enter the IP Address assigned by the router to the inverter, or the “Host Name” (that could be obtained writing this url: **http://ABB-XX-XX-XX-XX-XX-XX.local** replacing the “X” with the hex digits of the wireless MAC address of the inverter (it can be found on the “Wireless Identification Label” placed on the side of the inverter or applied during the commissioning phase to the quick installation guide on cover page)), to access the login page.



*In order to use the “Host Name” as an alternative to the dynamic IP address, the Wi-Fi router to which the board is connected (when operating in “Station Mode”) must provide the Domain Name System (DNS) service (contact the network administrator for further information regarding the presence or absence of the DNS service in the Wi-Fi router or how to enable it). In this way, even if the IP address assigned to the inverter should change over time, (dynamic IP), it will always be possible to use the same “Host Name” which will remain unchanged over time. **Android devices doesn’t allow the use of “Host Name” to access to the internal webserver!***



*The IP address assigned may vary for reasons connected to the wireless home router setup (for example, a very brief DHCP lease time). If verification of the address is required, it is usually possible to obtain the client list (and the corresponding IP addresses) from the wireless router administration panel.*



## **Connection to the inverter in “AP Mode”**

If the inverter wasn't connected to the domestic wireless network, follow this procedures:

- Enable the wireless connection on the device which is being used for the board setup (tablet, smartphone or PC) and connect it to the Access Point created by the inverter system: the name of the wireless network created by the system that the connection should be established with, will be:

### **ABB-XX-XX-XX-XX-XX-XX**

where “X” is a hex digit of the wireless MAC address (MAC address can be found on the “Wireless Identification Label” placed on the side of the inverter or applied during the commissioning phase to the quick installation guide on cover page).

- When prompted, type the “product key” (including the dashes. Example: 1234-1234-1234-1234) as the network password to access the inverter's access point. The product key is printed on the “wireless identification label” on the side of the inverter.
- Open an internet browser (recommended browser: Chrome versions from v.55, Firefox versions from v.50) and enter the pre-set IP address **192.168.117.1** to access the login page.

## Login page

After you have connected the device to the inverter and you access to the login page, login with the username and password created during the commissioning phase.

**Log In**

*i* No user logged-in

Username

Password

Log In

[Forgot your password?](#)



*User and password are CASE SENSITIVE.*



*If the Password is lost click on “Forgot your password?” to obtain the access to the webserver (and it will be possible to change the password) by entering the PRODUCT KEY (printed on the “Wireless identification label” and applied during the commissioning phase to the quick installation guide on cover page).*



*The language of the internal webserver could be changed in any moment by clicking on the right status bar:*

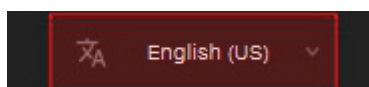

## webservice menu structure



*The following screenshots are related from a laptop visualization, may differ from smartphone or tablet visualization.*

The Webservice is divided in six main sections, available on the left sidebar:

**MAIN:** Main section of webservice dedicated to viewing the summary informations related the status and the production informations of the inverter and photovoltaic plant.

**SETUP:** Section dedicated to AC and DC line parameters configurations.

**EVENTS:** Section dedicated to viewing Alarms and Warnings event log.

**USER:** Section dedicated to User management.

**NETWORK:** Section dedicated to inverter communication settings and configurations.

**TOOLS:** Section dedicated to main service tools configurations.

**INFORMATION:** Section dedicated for general informations about the embedded webservice.



## MAIN section

In the **MAIN** section it's possible to access the following sub-menus:

- **Dashboard**
- **Status Summary**

### Dashboard

In the **Dashboard** sub-menu you can view the main informations related the status and the production informations of the inverter and photovoltaic plant and alarm/warning active events.

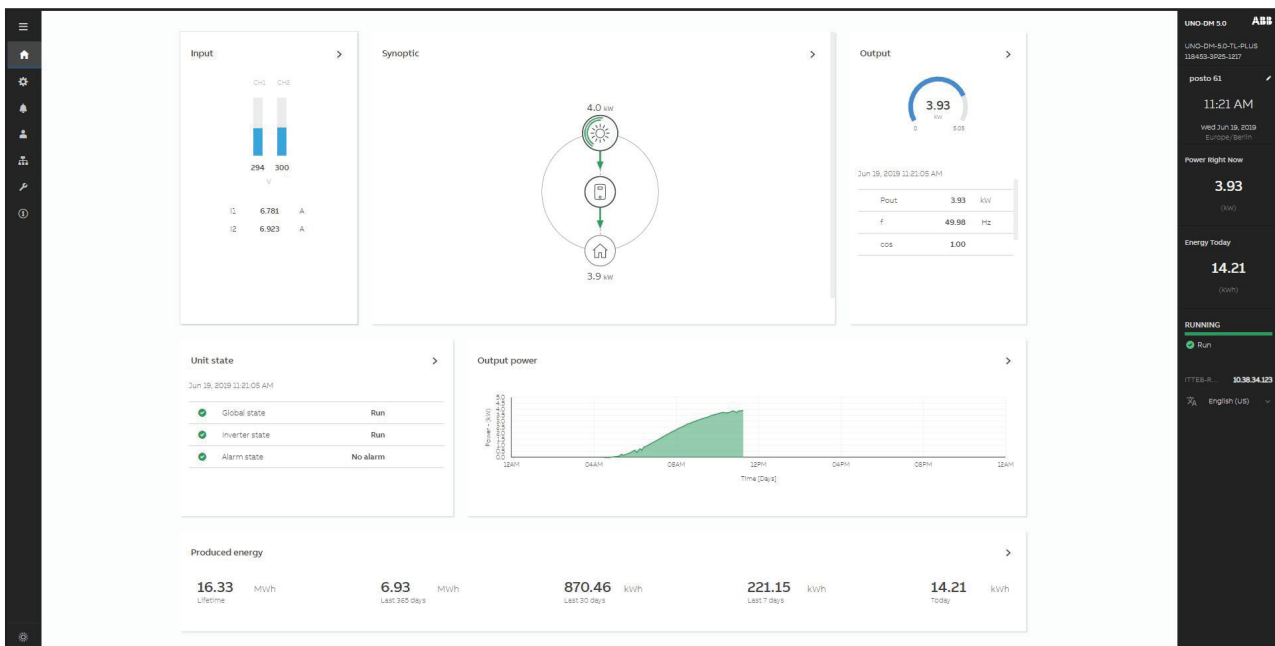

### Status Summary

In the **Status Summary** sub-menu you can view the detailed informations related the status and the production informations of the system.

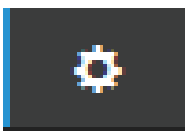

## SETTING section

In the **SETTING** section it's possible to access the following sub-menus:

- **Dynamic Feed-in control**
- **Inverter Parameters**
- **Digital Outputs**

### Dynamic Feed-in Control

In the **Dynamic Feed-in Control** sub-menu it's possible to enable the management of power flows in order to optimize self-consumption or avoid feeding power to the grid (except during transitory), basing on the reading of the energy meter:



*Installation of energy meter is required. Refer to the section "Connection of the energy meter" in the manual for the meter connection.*

### Dynamic Feed-In Control

#### Meter

Meter Model

Meter Phase

#### Energy Policy

Energy Policy

PV Generator Power (Wp)

Feed-In Power (% PV Generator Power)

**SAVE**

#### - Meter:

When a meter device is connected to the inverter, it's requested to select the meter model:

1. **None** (where system is installed without meter)
2. **REACT-MTR-1PH** (single-phase)
3. **FIMER 1PH** (single-phase)
4. **FIMER 3PH** (three-phase)



*If a 3PH energy meter (FIMER B23, B24) is used in the system as single-phase inverter, it will be necessary to select **FIMER 3PH** and the phase to which the inverter is connected.*

Once the meter model is selected, additional requested fields will appear:

- METER PHASE: If the METER is three-phase, the phase to which the inverter is connected must be selected. (This field will appear only if you select the FIMER B23 3PH meter model)

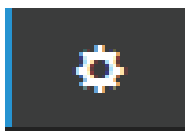

- **ENERGY POLICY:** set the way in which you want to manage the energy produced by the PV plant, choosing from the following:

Management mode	Description
-----------------	-------------

Self consumption	The system automatically manages power flows in order to maximise self-consumption. All unused power from domestic loads will feed into the grid. Using the Load Manager Relay, with the optional COM KIT, to program a power-on/power-off of a specific Load is it possible to increase the Self-consumption ratio
------------------	---

Zero injection	The system automatically manages power flows in order to avoid the injection of energy to the grid. If the meter is disconnected or not working the inverter's output power is restricted to zero in order to avoid accidental power feeding to the grid.
----------------	---

Configurable	The system automatically manages power flows in order to avoid feeding the grid with power greater than: $P_{DC} \times P_{lim}$ where $P_{DC}$ is the power of the photovoltaic generator ("PV GENERATOR POWER" parameter) and $P_{lim}$ is the output power limit with respect to $P_{DC}$ (%) ("FEED-IN POWER" parameter).
--------------	--

- **PV GENERATOR POWER:** Insert the power value of the photovoltaic system (kWp) installed.
- **FEED-IN POWER:** Set the percentage AC power restriction (with reference to the value of the photovoltaic system (kWp) installed) to be feed into the grid. This field can be edited only if the Energy Policy selected is "Configurable".

Confirm the settings by clicking "END" and the inverter will test the meter working.

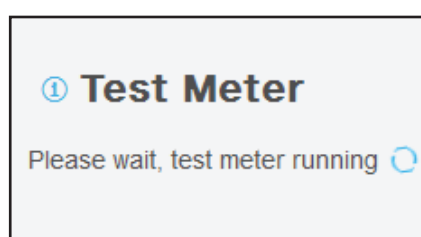

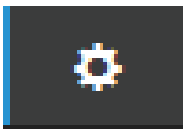

## Inverter Parameters

In the **Inverter Parameters** sub-menu you can setup the parameter related to the inverter:

### 1. AC Output rating (only Admin plus)

This submenu is used to set the AC output threshold.

### 2. AC Setting (only Admin plus)

This submenu is used to set the AC grid connection, voltage and frequency ride through protections

### 3. Active Power Control (only Admin plus)

This submenu is used to set the reduction of active power.

### 4. DC Setting

This parameter is used to set:

#### 4.1 VStart1 New Value

This parameter is used to set the Vstart activation voltage for the input channel 1 if they are configured independently (If parallel you will see only a single "Vstart" parameter for both channels). This voltage imposes a minimum input voltage on the inverter above which connection to the grid will be attempted.

#### 4.2 VStart2 New Value

This parameter is used to set the Vstart activation voltage for the input channel 2 if they are configured independently (If parallel you will see only a single "Vstart" parameter for both channels). This voltage imposes a minimum input voltage on the inverter above which connection to the grid will be attempted.



*We advise changing the activation voltage only if really necessary and to set it to the correct value: the photovoltaic generator sizing tool available on the FIMER website will indicate whether Vstart needs changing and what value to set it to.*

#### 4.3 Input Mode- Independent / Parallel

This settings allows you to set the input configuration mode.

In particular:

- **Independent:** Independent configuration of the two input channels. This configuration is set by default.
- **Parallel:** Parallel configuration of the input channels (single input channel). Other hardware settings must be set on the inverter to set this mode. Refer to the paragraph "Parallel channel configuration".

#### 4.4 UV Protection Time - Value

This section of the menu allows you to set the time for which the inverter stays connected to the grid after the input voltage has dropped below the Under Voltage limit (set at 70% of Vstart).

This value can be set from 1 to 3600 seconds (60 seconds is the default setting).

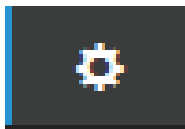

#### **5.4 Multiple Max Scan Enable**

This settings allows you to Enables/disables the scan for identifying the maximum power point of the system.

#### **6.4 Multiple Max Scan Period**

This settings allows you to set the time between scans. Remember that the shorter the scan interval the greater the loss of production, due to the fact that energy is transferred to the grid during the scan but not at the maximum power point. Each scan takes roughly 2 seconds.

#### **5. Digital Input**

This parameter is used to set the remote on/off of the inverter.

#### **6. Frequency Control: P(f) (only Admin plus)**

This parameter is use for modify the AC power in function of the frequency.

#### **7. Ramp Control (only Admin plus)**

This parameter is use for enable or disabled the normal ramp-up of output power or soft start after any or grid fault.

#### **8. Reactive Power Control (only Admin plus)**

This parameter is used for to set the reactive power features.





## Inverter Log Section

In the **Inverter Log Section** it's possible to view the Alarm and Warning events list that it can be custom filtered by type or by entering a matching word.

Clicking on any event to view his details.

⊕ Alarm History

CLEAR FILTERS
REFRESH EVENTS

All
Fault
Warnings
Info

⏪
◀
1 of 1
▶
⏩

Origin: inverter	23/02/2017 16:23:56
<span style="color: #007bff;">△</span> <b>W004</b> WARNING (CLOSED) AC GRID OVERVOLTAGE	
Origin: inverter	22/02/2017 19:01:11
<span style="color: #007bff;">△</span> <b>W007</b> WARNING (CLOSED) AC GRID UNDERFREQUENCY	
Origin: inverter	22/02/2017 18:32:06
<span style="color: #007bff;">△</span> <b>W022</b> WARNING (CLOSED) REACT POWER MODE CHANGED	
Origin: inverter	22/02/2017 17:10:06
<span style="color: #007bff;">△</span> <b>W006</b> WARNING (CLOSED) AC GRID OVERFREQUENCY	
Origin: inverter	22/02/2017 16:23:56
<span style="color: #007bff;">△</span> <b>W006</b> WARNING (CLOSED) AC GRID OVERFREQUENCY	

Event Details

Event Description

AC grid overvoltage - W004 - WARNING

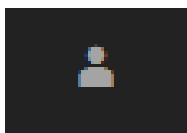

## USER section

In the **USER** section it's possible to logout from webserver and return to the login page, or to access the following sub-menus:

- **Edit Email and Password**
- **Admin Plus**
- **User Management**

### Edit Email and Password

In the **Edit Email and Password** sub-menu you can change the e-mail and password related to the user which is used to login to the webserver:

### Admin Plus

By accessing to the **Admin Plus** sub-menu you can obtain the “Admin Plus” user privileges which allow you to:

- Change the grid standard of the inverter, after 24 hours while the inverter is operating ( so the **Country Standard** sub-menu on **TOOLS** section is locked).
- View and edit the **Setup AC** sub-menu on **SETUP** section.
- View and edit the “**MPPT Noise amplitude**” field in **Setup DC** on **SETUP** section.

To access on the internal webserver with the “Admin Plus” user privileges it's required to enter a security token that it can be obtained by registering on the website <https://registration.solar.fimer.com>. Refer to the dedicated section on this topic in the manual.

### User Management

By accessing to the **User Management** sub-menu it's possible to edit all the users already created and create new users (both with admin or User privileges).



## CONNECTIVITY section

In the **NETWORK** section it's possible to access the following sub-menus:

- **RS485**
- **WLAN**
- **LAN**
- **Debug Settings**

### **RS485**

In the **RS485** sub-menu it's possible to adjust the settings relating to the RS485 communication serial line:

- **RS485 Node Address**: It allows you to set the address for serial communication of the individual inverters connected to the RS485 line. The UP and DOWN buttons scroll through the numerical scale. (The addresses that can be assigned are 2 to 63).
- **RS485 Baud Rate**: It allows you to set the Baud Rate (2400/4800/9600/19200/34800/57600/115200).
- **RS485 Protocol Type**: It allows you to set the type of protocol to be used for the RS485 line.
  - "Protocol Aurora Server": it's the proprietary FIMER serial protocol usually used for back-compatibility or by service personnell.
  - "Modbus Sunspec Server": General purpose communication protocol to be selected to enable monitoring and control.
  - "Modbus Meter Interface": communication protocol to be selected for enable communication with the supported external meter.
- **RS485 Parity Mode**: It allows you to set the Parity bit (No Parity, Even Parity, Odd Parity).



## WLAN

In the **WLAN** sub-menu it's possible to view operation status and the information about the WLAN board for both of wireless channel and to switch between the two operation mode ("Station Mode" or "AP Mode").

### WLAN Status

#### Wireless channel 1

**You are connected through the channel 1 (Access Point)**

Mode:	Access Point
Status:	<b>on</b>
SSID:	ABB-b0-72-bf-9f-e4-6a
IP:	192.168.117.1

#### Wireless channel 2

Mode:	Station
Status:	<b>connected</b>
Connected to:	Home_Network
Signal level:	Strong
IP:	10.21.43.201
Netmask:	255.255.252.0
DNS:	
Gateway:	it-r-valwificli

DISCONNECT

#### Edit channel 2 configuration

IP Settings

DHCP

Available Network (SSID)

Home\_Network

↻

Password

.....

Show password

Back
Apply changes

Wireless channel 1 is always active and it's dedicated to operate in Access Point mode only.

Wireless channel 2 is dedicated to operate in "Station" mode. If the inverter is connected to channel 2 it will be shown all information regarding the wireless parameters.

You will be able to edit the configuration of wireless channel 2 only connecting to the channel 1.

If you are connected via channel 2, you can switch to Access Point mode and disconnect the inverter from the domestic wireless network by clicking "Switch to AP mode" button.

If the inverter wasn't previously connected to the router, it will now be possible to connect it by entering the following wireless network parameters (set on the router):

- IP Selection Mode: DHCP or Static:

If you select the DHCP function (default setup) the router will automatically assign a dynamic IP address to the inverter whenever it tries to connect to the user network.

With Static, the user can assign a fixed IP address to the system. The data which has to be entered in order for IP static address assigning to take place will appear. Complete the additional fields at the bottom of the screen (all the fields are mandatory with the exception of the secondary DNS server).

- Available Network (SSID):

Identify and select your own (home) wireless network from all those shown in the SSID field (you can carry out a new search of the networks that can be detected with the Update button ↻). Once the network has been selected, confirm.

- Password (wireless network password):

Enter the password for the destination network (if necessary) and start the connection attempt (it will take a few seconds).

Click on "Connect" button to switch the inverter wireless connection from point to point to the home wireless network.

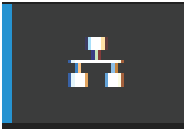

**Wireless network connection:**

**Home\_Network**

The inverter is going to be connected to the wireless network **Home\_Network**

On-going attempt to connect to the wireless network **Home\_Network**

Back Next

Once the inverter is connected to the domestic wireless network, a new message will confirm that the connection is acquired.

**Wireless network connection succeeded:**

**Home\_Network**

The inverter has been successfully connected to the wireless network **Home\_Network**

The connection to the wireless network **Home\_Network** succeeded.

IP address: **10.21.43.201**

Please take note of the address.

Back Next

The message provides the IP Address assigned by the home wireless network router to the inverter that can be used each time you want to access the internal webserver, with the inverter connected to the home wireless network. **Take note of it.**

Click the “Next” button” to complete the setup of “Station Mode” connection.



*The IP address assigned may vary for reasons connected to the wireless home router setup (for example, a very brief DHCP lease time). If verification of the address is required, it is usually possible to obtain the client list (and the corresponding IP addresses) from the wireless router administration panel.*



*The most common causes of losing connectivity might be: different wireless network password, faulty or unreachable router, replacement of router (different SSID) without the necessary setting updates.*



*Where possible, "Station Mode" is always preferable. Thanks to the internet connection, this mode ensures better operation.*

## LAN

The LAN is connected only if the COM Ethernet KIT expansion card is present. In the LAN sub-menu it's possible to view the status and change the daisy chain configuration of the two ethernet ports of the inverter.

### - Daisy chain configuration: DHCP or Static:

By selecting the DHCP function (default setup) the router will automatically assign a dynamic IP address to the inverter whenever it tries to connect to the user network.

With Static, the user can assign a fixed IP address to the system. The data which has to be entered in order for IP static address assigning to take place will appear. Complete the additional fields at the bottom of the screen (all the fields are mandatory with the exception of the secondary DNS server).

## Debug Settings

In the **Debug Settings** sub-menu it's possible to enable or disable the Debugging access for FIMER Service purposes.

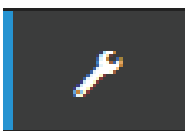

## SERVICE TOOLS section

In the **TOOLS** section it's possible to access the following sub-menus:

- **Country Standard**
- **Firmware Update**
- **Date/Time**
- **Reset AFD**

### Country Standard

By accessing to the **Country Standard** sub-menu you can modify the grid standard within 24 hours while the inverter is operating.



*After the grid standard was set you have 24 hours to make any changes to the grid standard value; 24 hours later the **Country Standard** sub-menu will be locked, and any subsequent changes can only be made accessing with **Adim Plus** privileges. Refer to the dedicated section on this topic in the manual to know how to unlock the **Country Standard** sub-menu.*

### Country standard

① You can change the parameter in the first 24 hours if you logged in as admin. After this time, you can reset the 24 hours only if you logged in as admin plus

Grid Standard

CEI 021 - internal protection ▼

RESET
SAVE

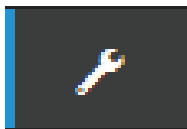

## Firmware Update

By accessing to the **Firmware Update** sub-menu you can upgrade the firmware of the inverter and his components selecting a Remote firmware Update or a Local firmware Update.



*Perform the update during good irradiation conditions (avoid the dawn and dusk hours).  
An interruption of updating process could damage the inverter!*

### • Remote firmware Update:

- In remote mode, the firmware will update automatically, searching the last available firmware on FIMER servers, by clicking the “CHECK” button.

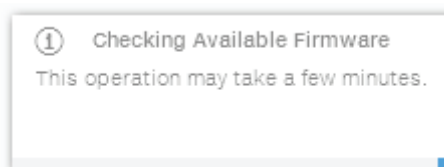

- After the finish of the checking process the available release will be notified on the bottom part of the section
- Click on “UPDATE” button to start with the updating process.

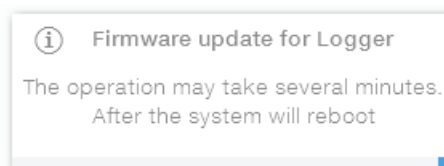

### • Local firmware Update:

By updating in local mode, the firmware have to be selected and uploaded from local folder of the used devices to access to the web server.

The latest firmware version is available from the download area of the website **[www.fimer.com](http://www.fimer.com)** or from **<https://registration.solar.fimer.com>**

- Click on “FW SELECT” and select the firmware package previously downloaded.

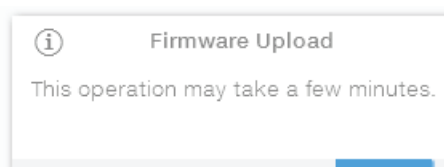

- Click on “UPDATE” button to start with the updating process.

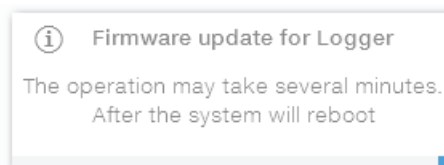



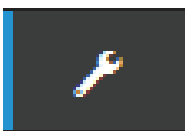

## Date and Time

In the **Date and Time** sub-menu it's possible to set the date, time and time zone.

The inverter will propose these fields when the time protocol is available).

When it's not possible for the inverter to detect the time protocol, these fields have to be manually entered.

### Date and Time

✔ Network Time Protocol server has been detected and it will be used to keep the system clock synchronized.

Date ✔

Feb 22, 2017

SET by the NTP server

Time ✔

4:52 PM

SET by the NTP server

Time Zone

Europe/Berlin GMT+01:00 ▼

SAVE

## Reset manufacturing (only Admin plus)

In the **Reset Manufacturing** sub-menu it's possible to reset country standard, restore default and the connectivity reboot

## Reset AFD

In the **Reset AFD** sub-menu it's possible to reset the arc fault.

This will clear the E050 error and restart the self test. If self-test results are OK, the inverter will reconnect to the AC grid; if the DC arc fault is still present, the self-test will result in error E053.



## Information

In the **INFORMATION** Section it's possible to view the general informations about the embedded Web User Interface.

it's possible to access the following sub-menus:

- **Product Info**
- **Privacy Policy**
- **Provider Information/Impressum**
- **Acknowledgments**
- **Release Notes**

## General conditions

Routine and periodic maintenance operations must only be carried out by specialized staff with knowledge of how to perform these tasks.



*Some inverter parts may be subject to voltages that could be hazardous for the operator. Before performing any work on the inverter, refer to “Inverter total de-energization and safe access” chapter on this manual to know all the necessary steps to safely operate on the inverter.*



*For cleaning, DO NOT use rags made of filamentary material or corrosive products that may corrode the equipment or generate electrostatic charges.  
Avoid temporary repairs. All repairs should be carried out using only genuine spare parts.  
The maintenance technician is to promptly report any anomalies.*

DO NOT allow the equipment to be used if problems of any kind are found.



*Always use personal protective equipment (PPE) provided by the employer and comply with local safety regulations.*

## Inverter total de-energization and safe access

The purpose of this chapter is to provide instructions for de-energize the UNO-DM-PLUS models in order to allow access to active parts inside the inverter. The procedure describes the steps to perform a total isolation and thus includes operations on devices that are located outside the inverter. The total isolation approach consider **the disconnection of the inverter from any possible voltage source to which the inverter may be connected**. In the procedure the test of residual voltage potentially present inside the inverter is included. This procedure is intended exclusively to be used by skilled or trained persons in accordance with safety standards EN 50110-1 and EN 50110-2 (CENELEC/CEN) or equivalent standards. Furthermore, only these skilled or trained persons are permitted to carry out the procedure.

### Operator and maintenance personnel skills/prerequisites



*Personnel in charge of using and maintaining the equipment must be skilled for the described tasks and must reliably demonstrate their capacity to correctly interpret what is described in the manual.*



*For safety reasons, the installation must be performed by qualified installers and/or licensed electricians in accordance with the existing regulations in the country of installation and in accordance of all safety rules for performing electrical works. The installers must have demonstrated skills and knowledge of the inverter's structure and operation.*



*Inverter operation and maintenance by a person who is NOT qualified, is intoxicated, or on narcotics, is strictly forbidden.*



*The customer has civil liability for the qualification and mental or physical state of the personnel who interact with the equipment. They must always use the personal protective equipment (PPE) required by the laws of the country of destination and whatever is provided by their employer.*

The following job requirements and qualifications are required to operate on the inverter:

- Compliance with all legal standard in force in the installation country to perform the electrical work described on this procedure.

## Clothing and protection of personnel

The following Personal Protective Equipment (PPE) are required to perform any intervention on the inverter:

- Dielectric helmet EN397 – EN50365 (1000Vac-1500Vdc) with visor EN166 grade 8.
- Insulating composite gloves class 0 EN60903 (1000Vac-1500Vdc) resistant to electric arc class 2 (7kA) EN61482-1-2 in combination with protective overglove in leather EN420 – EN388.
- Basic arc-flash rated wearing with IEC Class 1 (8 cal/cm<sup>2</sup>).
- Arc-flash rated head protection (balaclava) with IEC Class 1 (8 cal/cm<sup>2</sup>).
- Safety shoes.

## Safety equipment and tools

The following equipment and tools are required to perform any intervention on the inverter:

- Disconnect tool for DC side.
- Voltage detector (EN 61243-2) capable of 3kVdc and up to 1kVac.
- DC current clamp.
- Multimeter (only to test the absence of short circuits).
- Safety tags “work in progress, do not operate”.
- Padlocks.

## Inverter total de-energization and safe access procedure

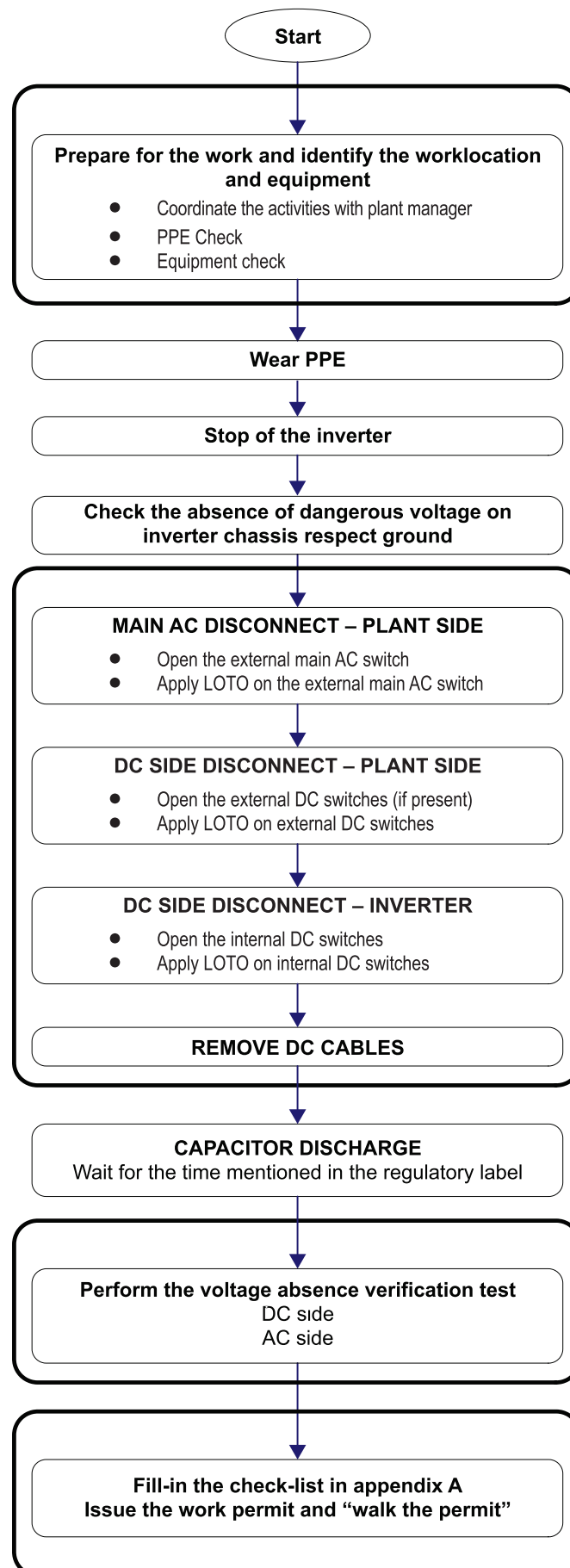



When the device has just been switched off, it may have hot parts as a result of overheating of the heated surfaces (e.g.: transformers, accumulators, coils, etc.) so be careful where you touch.



Some inverter parts may be subject to voltages that could be hazardous for the operator. Before performing any work on the inverter, follow this procedure for safely isolate the inverter.

### 1. Preliminary checks

- Weather conditions: In the risk assessment prior the intervention it is of paramount importance to evaluate the weather conditions. This procedure can be applied only in case of dry environment. Don't proceed in case of rain (even light) or high humidity.
- PPE Check: Verify the integrity of the PPE that is going to be used to perform the operations.
- Equipment check:
  - Check the voltage tester is working correctly:
    - Perform an integrity check of the instrument in general; examine the test terminals, its integrity and make sure they are properly fixed; make sure the batteries level is enough high (don't use the instrument in case the message "LOW BATTERY" is present) or replace them.
    - Perform test of the instrument using an energized AC socket and a DC voltage source (example: battery in the service car) with known voltage level; in case the instrument is provided with a self-test feature, follow the instructions provided in the instrument manual to carry out the self-test.
  - Check the DC current probe is working correctly:
    - Check the DC current probe is properly working, make sure to perform the "ZERO-OFFSET" procedure and to select DC measurement range.

### 2. Wear the appropriate PPE for carrying out the operations (arc-flash rated wearing, dielectric helmet with visor, Arc-flash rated head protection (balaclava), insulating gloves). All the following activities (till the completion of the procedure) must be performed wearing the PPE.

### 3. Check the absence of dangerous voltages on inverter enclosure respect to ground:

- Using a voltage detector, check the absence of dangerous voltage on the inverter chassis. The measurement points are between the inverter chassis (it shall be selected a non-painted point, like one of the screws of the front panel) and a ground point outside the inverter.

#### 4. Operations on External AC switches

The diagram below represents a possible arrangement of the PV plant. Depending on the design choices made by the developer of the plant some of the devices could not be present. Identify the external AC switch(es) in the plant with the support of the plant manager.

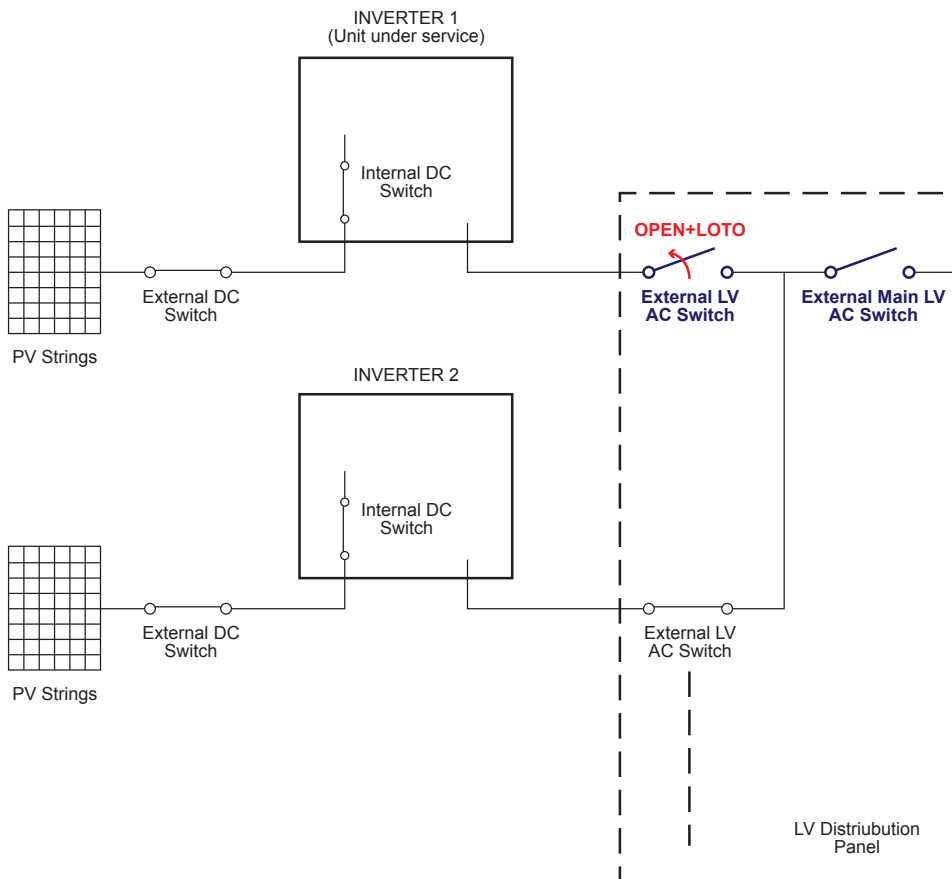

- Open the external AC disconnect switch or the main external AC disconnect switch (blue in below picture) outside the inverter (IEC 60364-7-712.536.2.2).
- Affix designated lock preventing operation onto any external AC disconnect device, affixing designated tags (LOTO procedure).



*Identification of the external switch may require the cooperation of the plant manager and it must be included in the switching plan defined during the preparation of the work.*

- Check on the status LEDs 02 the shutdown command has been carried out (Missing Grid status):
  - **Power** LED (Green): Flashing
  - **Alarm** LED (Yellow): ON (solid)
  - **GFI** LED (Red): OFF
  - **WLAN/LAN** LED (Blue): Depends by the communication status.



### 5. Operations on External DC switches (if present)

**Note:** In case of absence of External DC disconnect device skip this step.

The diagram below represents a possible arrangement of the PV plant. Depending on the design choices made by the developer of the plant some of the devices could not be present. Identify the external DC switch(es) in the plant with the support of the plant manager.

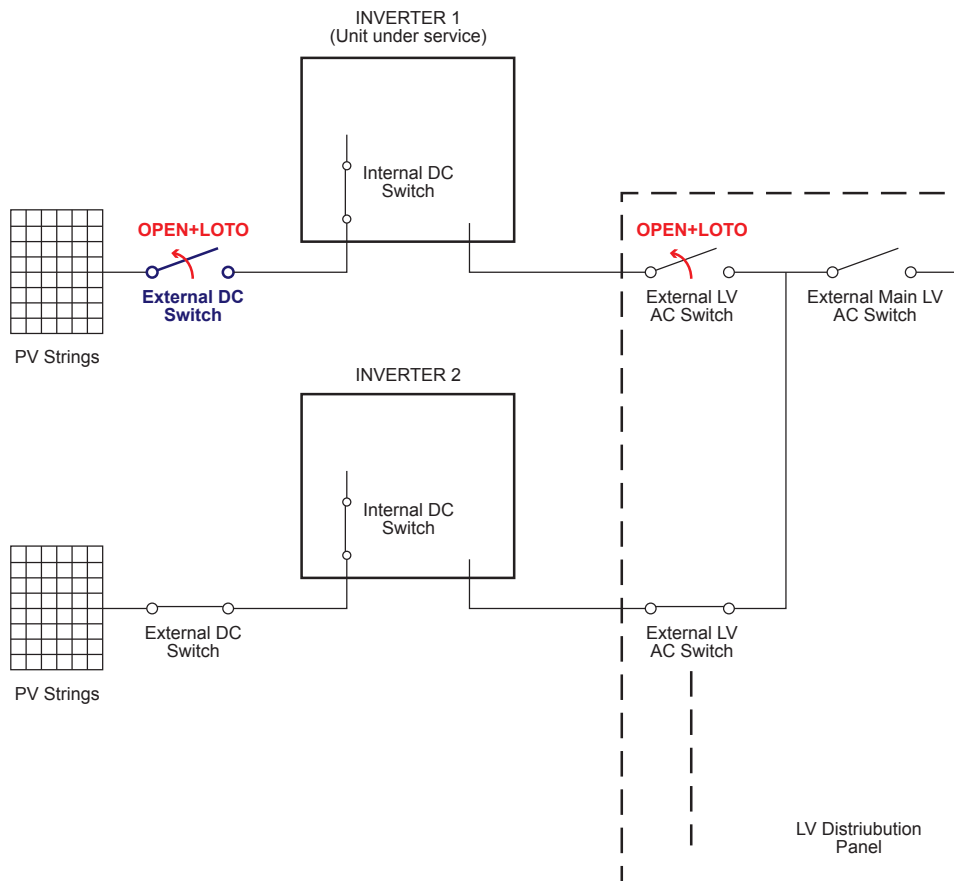

- Open the external DC disconnect switch (blue in below picture) outside the inverter (IEC 60364-7-712.536.2.2)
- Affix designated lock preventing operation onto any external DC disconnect device, affixing designated tags (LOTO procedure).



*Identification of the external switch may require the cooperation of the plant manager and it must be included in the switching plan defined during the preparation of the work.*

- Check on the status LEDs **02** the shutdown command has been carried out (Missing DC voltage status): **All LEDs OFF**.



*The time needed for the complete shut-down of the LEDs depends by the input voltage of the inverter. The complete shut-down of the LEDs may require some minutes.*

## 6. Operations on Internal DC disconnect switch 06

- Open the internal DC switch 06 (blue in the below picture).

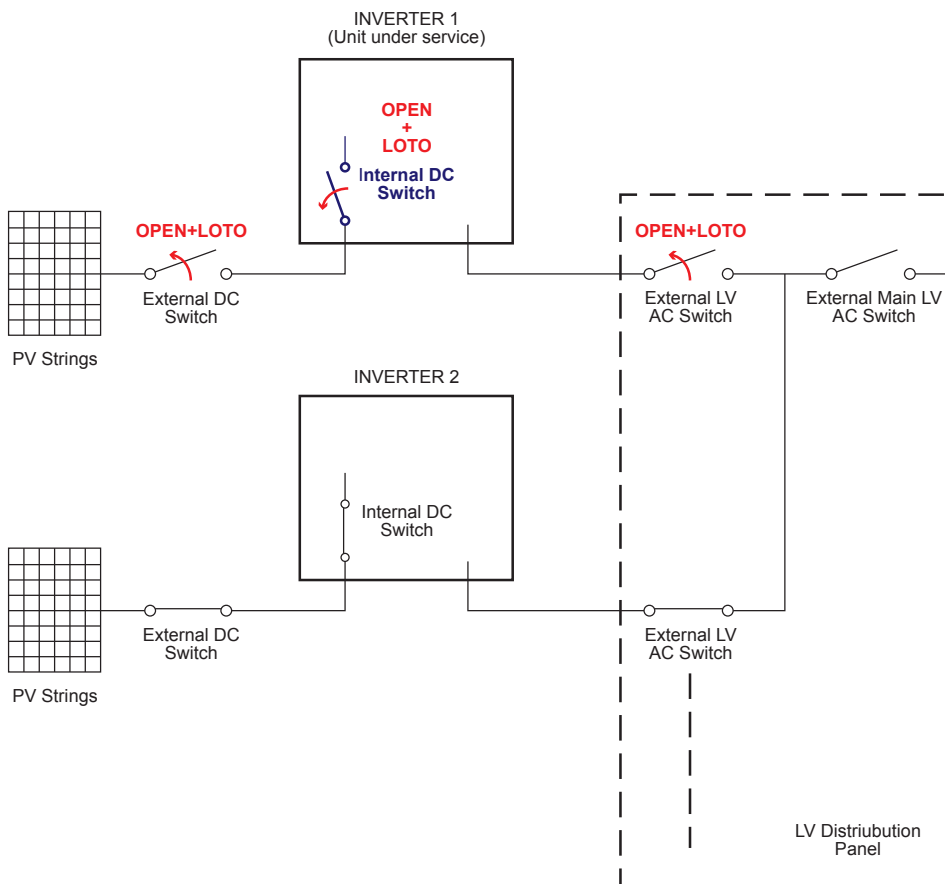

- Affix designated lock preventing operation onto DC disconnect switch 06, affixing designated tags (LOTO procedure).
- Check on the status LEDs 02 the shutdown command has been carried out (Missing DC voltage status): **All LEDs OFF**.



*The time needed for the complete shut-down of the LEDs depends by the input voltage of the inverter. The complete shut-down of the LEDs may require some minutes.*

The below picture represents the expected status of the switches in the plant after the switching operations have been completed.

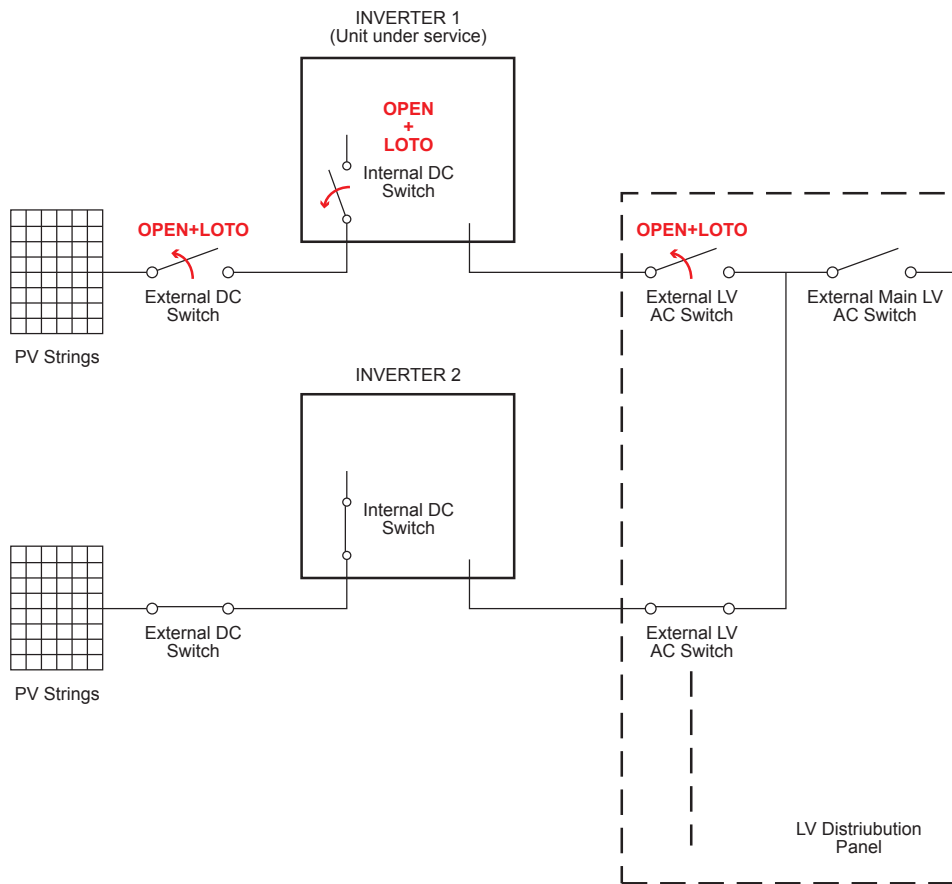

## 7. Remove the DC cables

- Using the current clamp check the absence of current on DC side, measurement each positive and negative DC input string cables (check the correct setting of the current sensor).
- Remove DC cables from the DC Input terminal block **12**. To avoid mechanical interferences, use a cable tie to collect the disconnected cables.



*It is highly recommended to put labels on the cables in order to easily reconnect them to the correct connectors once completed the service activities.*

## 8. Discharge of the capacitor

- Wait the internal capacitors to be discharged. The discharge time of the stored energy is indicated on the regulatory label.

## 9. Open the cover

- Access to the inverter by removing the wiring box front cover **05**.
- Visually inspect the components to identify the presence of any overheating, signs of electric arcs, failure of the insulating devices, loosen connections or cables not connected.

## 10. Voltage absence test on DC side



*Before to approach the below operations all the steps from 1 to 9 included must be successfully completed.*

Using the voltage detector, check the absence of voltage on the DC Input terminal block **12** between:

- Each positive input and ground
- Each negative input and ground
- Positive input and negative input of each input section of the inverter.

## 11. Voltage absence test on AC side

Using the voltage detector, check the absence of voltage on the AC terminal blocks **13**. (lift the protective sheet to reach the connectors) between:

- Phase to ground
- Neutral to ground
- Phase to neutral.

**13. Check list to be filled prior the access to the inverter**

- Purpose of the checklist is to verify that all the operations mentioned in the procedure have been carried out. The checklist below must be attached to the intervention report.

CHECK	STATUS $\checkmark$ or X
Prepare for the work and identify the work location and equipment	
PPE and Equipment Check	
PPE wearing	
<b>OPERATIONS AT PLANT LEVEL [*]</b>	
Check the absence of dangerous voltages on inverter chassis respect ground	
Operations in External AC switch	
Operations in External DC Switch (If present)	
<b>OPERATIONS AT INVERTER LEVEL</b>	
Operations on internal DC switches (If present)	
Remove the DC quick fit connectors from inverter	
Wait the discharge of the internal capacitor	
Open the cover and visually inspect the components	
<b>VOLTAGE ABSENCE TEST</b>	
Voltage absence check on DC side	
Voltage absence check on AC Side	
<b>ISSUE WORK PERMIT</b>	
Issue work permit and "Walk the permit" – Check list filling	

== ONLY if all checks are POSITIVE ( $\checkmark$ ) the ACCESS IS ALLOWED =

[\*]: Identification of the external switch may require the cooperation of the plant manager and it must be included in the switching plan defined during the preparation of the work.

## Routine maintenance

To preserve long term proper operation of the inverter, you are advised to perform the routine maintenance operations listed in this chapter.



*Maintenance operations shall be performed only by qualified personnel or FIMER personnel (under a servicing contract). The maintenance schedule may vary depending on the environmental conditions of the installation.*

**Table: routine maintenance**

<p><b>Annual visual inspections</b></p>		<ul style="list-style-type: none"> <li>• Check that the inverter is operating properly, without any alarm signals</li> <li>• Ensure that all the safety labels and symbols are visible</li> <li>• Check the integrity of the cables, connectors and cable glands outside the inverter</li> <li>• Check that the environmental conditions have not changed dramatically from those on installation</li> <li>• Check there are no obstacles (animals, insects, leaves or anything which could reduce the heat exchanging capacity of the heat sink) at the top, at the bottom and between the fins.</li> </ul>
<p><b>Annual operations</b></p>		<ul style="list-style-type: none"> <li>• Check the tightening of the cable glands and AC connector cable gland.</li> <li>• Check the front cover is fixed</li> <li>• If there is no monitoring system, check the record of alarms and errors using the indications given in the manual in order to check recent malfunction signals</li> </ul>
<p><b>Annual cleaning</b></p>		<ul style="list-style-type: none"> <li>• Clean the equipment; in particular the heat sink (using compressed air)</li> </ul>

## Troubleshooting



Operations on the inverter to identify and address any faults may only be performed by the installer or by qualified personnel.

### Internal Web user interface and wireless communication troubleshooting

The following table gives a list of main and most common errors or problems relating to the wireless communication between inverter and user devices.

Problem	Possible causes	Solution
The internal web user interface cannot be accessed.	ADMIN or USER password forgotten.	Reset the passwords by clicking on "Forgot your password"; The passwords can be reset after having entered the "Product Key" code that can be found on the "Wireless Identification Label".
The inverter is able to identify a wireless network but is unable to connect to it.	The signal between the inverter and the wireless router to which the board wants to connect is too weak.	Modify the position of the wireless antenna, the inverter or the router.
		Make sure that the inverter has not been installed near obstacles which could affect the communication with the wireless router (for example: metal cages or walls, walls in reinforced concrete, electromagnetic fields).
		Move the router as close as possible to the inverter.
The inverter is unable to connect to a wireless network.	The wireless network to which the inverter is to be connected, could require the user to enter a username and password to allow navigation (for example, with a public wireless network or a hotel).	Install a wireless signal repeater in order to extend the network to which the inverter is to be connected; then connect the inverter to the repeater.
		Unfortunately the inverter cannot be connected to these types of wireless networks. Connect the inverter to an alternative wireless network.
The Inverter has not identified the wireless network to which connection is required.	The wireless network to which the Inverter is to be connected, is set so as not to be identified (hidden network).	The Inverter is not able to connect to a hidden network. Set the wireless network to which the inverter is to be connected (visible network), then identify and connect the Inverter to the wireless network as normal.
		Modify the position of the wireless antenna, the inverter or the router.
		Make sure that the inverter has not been installed near obstacles which could affect the communication with the wireless router (for example: metal cages or walls, walls in reinforced concrete, electromagnetic fields).
The wireless board does not communicate correctly with the inverter inside of which it is installed (inconsistency in the detected data read by the board), or when working in "Access Point Mode", it's not possible to access the internal web user interface.	Wrong Inverter Date/Time settings.	Move the router as close as possible to the inverter.
		Install a wireless signal repeater in order to extend the network to which the inverter is to be connected; then connect the inverter to the repeater.
Alternating difficulties in the local connection to the internal web user interface.	The wireless board of the inverter could be damaged.	Request a service intervention to check that the inverter wireless board is working correctly.
	The inverter might not be correctly powered (for example, if the inverter is switched off at night, the internal web user interface cannot be accessed).	Check if Date/Time has correctly set on the inverter; correct it if necessary.
The wireless connection signal between the device in use and the router or the Inverter, may not have sufficient power or it may be disturbed by obstacles which affect the communication.	The wireless connection signal between the device in use and the router or the Inverter, may not have sufficient power or it may be disturbed by obstacles which affect the communication.	Access to the internal web user interface only when the inverter is correctly powered.
		Make sure that the signal between the wireless devices which interact with the inverter are sufficiently high and that any obstacles such as metal cages or walls, walls in reinforced concrete or strong electromagnetic fields do not affect communication.

Problem	Possible causes	Solution
Although the Inverter has been configured correctly in "Station Mode" and works correctly on the local network, no data has been transmitted to the Aurora Vision®.	The MAC address used to register the inverter on the Aurora Vision® platform is not the same as the actual address associated with the inverter.	Make sure that the MAC address registered on the Aurora Vision® platform is actually the one associated with the inverter. If it is not, modify the registered MAC address.
	The wireless network to which the Inverter is connected, could be protected by a Firewall which prevents the remote exchange of data with the Aurora Vision® platform.	Contact the network administrator in order to have the Firewall configured so that the remote exchange of data between the Inverter and the Aurora Vision® platform is allowed.
It is not possible to access the Internal web user interface using the IP address when the inverter is operating in "Station Mode – DHCP".	An incorrect dynamic IP address is being used to access the Internal Web user interface or the IP address could have been modified by the wireless router to which the inverter is connected.	Access the Internal Web user interface using via "AP Mode" (refer to dedicated section to know how to connect via "AP Mode") and read the current IP Address in "NETWORK > WLAN" section. Access the Internal Web user interface using the "Host Name" that could be obtained writing this url <b>http://ABB-XX-XX-XX-XX-XX-XX.local</b> replacing the "X" with the hex digits of the wireless MAC address of the inverter (it can be found on the "Wireless Identification Label" placed on the side of the inverter or applied during the commissioning phase to the quick installation guide on cover page). The DNS or multicast service must be enabled on router. <b>Note: This connection method doesn't work on Android devices.</b>
	The IP Address used to access the Internal Web user interface was lost.	If possible, access the pages of the wireless router web server to which the inverter is connected and read the new dynamic IP address assigned to the Inverter.
	The wireless router doesn't allow the connection to local IP address. Typically this happen on company networks.	Contact the network administrator to allow the wireless router to connect to local IP address.
	The device doesn't allow the connection to local IP address. Typically this happen with company devices.	Contact the system administrator to allow the device to connect to local IP address.
Using an Android devices, a notification advise that internet connection is missing when trying to connect to the Access Point wireless network created by the inverter and ask for connection confirmation.	Known behavior of Android devices. Android OS always check if internet connection are available and ask for confirmation if it's not present.	Confirm the connection request in the notification of Android devices by clicking "Yes".
It is not possible to view the Pdf Auto-test report using an Ios devices.	Popup opening is not allowed on Ios browser.	Allow the popup opening in the browser settings of the Ios devices (A notification will advise you for enable popup when trying to view the pdf autotes report).















## Alarm Messages of the Inverter











In order to understand and resolve warning (Wxxx) or error (Exxx) signals that appear in the Alarm section of the internal web user interface, follow the table given in the following paragraph.

The equipment can notify errors/warnings in the Alarm section of the internal web user interface only if the input voltage is greater than the Vdcmn voltage (POWER Led flashing or lit; see chapter on operation)











*The following table gives the complete list of errors/warnings relating to string inverters. Some error/warning codes may not be used depending on the inverter model installed.*

- Error code - Error message - Signal	Name of Alarm and Cause	Solution
- R-Iso Low - Ground Fault -  GFI LED	<b>Ground fault of photovoltaic generator:</b> The alarm is generated when a leakage current to ground is detected in the DC section of the system.	<ul style="list-style-type: none"> <li>• Measure the insulation resistance using a megohmmeter positioned in the photovoltaic field (positive terminal short-circuited at the negative pole) respect to ground. The measurement is strongly influenced by the environmental conditions, so must be made under the same conditions in which the error occurred.</li> <li>- If the value measured is lower than 1 megaohm, a check must be carried out by a technician/installer on the photovoltaic generator to identify and eliminate the problem.</li> <li>- If the value measured is higher than 1 megaohm and the error signal persists, contact customer assistance.</li> </ul>
- No code - SET COUNTRY or NO NATION -  No LED	<b>SET COUNTRY or NO NATION:</b> Indicates that in the installation phase the grid standard was not set on the inverter.	<ul style="list-style-type: none"> <li>• Set the grid standard of the country of installation following the instructions given in this manual for the inverter.</li> <li>- If the signal persists also after the grid standard has been set, contact customer assistance.</li> </ul>
- No code - Missing Grid -  Alarm LED	<b>Missing Grid:</b> The inverter displays the "Missing Grid" message when it does not record output voltage (AC side).	<ul style="list-style-type: none"> <li>• Check the grid voltage on the inverter's AC terminal block.</li> <li>- Should it be absent, check any protection work on the line and the presence of grid voltage on the supply point.</li> </ul>
- No code - Memory Fail -  Alarm LED flash.	<b>Memory fail:</b> The inverter displays the "Memory Fail" message when it records a communication problem with the memory board on which the inverter saves the daily value of energy produced.	<ul style="list-style-type: none"> <li>• Remove the memory board and check the welding of all the connector's terminals. Subsequently reinsert the memory board and check that it is correctly inserted into the dedicated slot</li> <li>- If the signal persists also following the above checks, contact customer assistance.</li> </ul>
- No code - Waiting Sun -  Power LED flash.	<b>Waiting Sun:</b> The inverter displays the "Waiting Sun" message when, following a W001 and/or W002 notice, the voltage from the photovoltaic generator is less than the activation voltage (Vstart).	<ul style="list-style-type: none"> <li>• Check the input voltage on the inverter.</li> <li>- If it does not exceed Vstart, check for the presence of sufficient irradiation and the correct composition of the system.</li> <li>- If it exceeds Vstart, contact customer assistance</li> </ul>
- W001 - Sun Low -  Alarm LED	<b>Insufficient irradiation (Low input voltage on switching on the inverter):</b> Incorrect configuration of the PV generator or an "on the limit" configuration for the inverter's minimum input voltage.	<ul style="list-style-type: none"> <li>• Check the input voltage on the inverter.</li> <li>- If it does not exceed Vstart, check for the presence of sufficient irradiation and the correct composition of the system.</li> <li>- If it exceeds Vstart, contact customer assistance</li> </ul>
- W002 - Input UV -  Alarm LED	<b>Insufficient irradiation (Low input voltage on switching off):</b> Incorrect configuration of the photovoltaic generator or an "on the limit" configuration for the inverter's minimum input voltage	Check the input voltage on the inverter. <ul style="list-style-type: none"> <li>- If it does not exceed Vstart, check for the presence of sufficient irradiation and the correct composition of the system.</li> <li>- If it exceeds Vstart, contact customer assistance</li> </ul>

- Error code - Error message - Signal	Name of Alarm and Cause	Solution
- W003 - Grid Fail -  Alarm LED	<b>Parameters of grid voltage outside range:</b> This error signal occurs when during the inverter's normal operation the grid parameters exceed the limits imposed by the grid standard set on the inverter and by the grid operator or the utility: - Grid voltage absent (after the signal the inverter goes to "Missing Grid") - Unstable grid voltage (down or up) - Unstable grid frequency	<ul style="list-style-type: none"> <li>• Check the grid voltage on the inverter.</li> <li>- Should it be absent, check for absence of grid voltage on the supply point.</li> <li>- If, on the other hand, the voltage tends to rise (when the inverter is connected) there is high line or grid impedance.</li> <li>• Check the grid voltage also on the supply.</li> <li>- If it is high, it means that there is high grid impedance. In this case, ask the operator to adjust the grid voltage. If the operator authorises a change to the inverter's parameters, you can set the new limits into "Setup&gt;Setup AC side" of the internal web user interface (refer to dedicated sections of this manual for further information).</li> <li>- If the voltage at the point of supply is much lower than that measured on the inverter, it is necessary to adjust the line (inverter-contactor).</li> <li>- If the voltage and the grid frequency come back within the limits (also when the inverter is connected to the grid) contact customer assistance</li> </ul>
- W004 - Grid OV -  Alarm LED	<b>Grid overvoltage:</b> This error signal occurs when during the inverter's normal operation the grid voltage exceeds the maximum limit set by the operator.	<ul style="list-style-type: none"> <li>• Check the grid voltage on the inverter.</li> <li>If the voltage tends to rise (when the inverter is connected), there is a problem of high line or grid impedance.</li> <li>• Check the grid voltage also on the supply.</li> <li>- If it is high, it means that there is high grid impedance. In this case, ask the operator to adjust the grid voltage. If the operator authorises a change to the inverter's parameters, you can set the new limits into "Setup&gt;Setup AC side" of the internal web user interface (refer to dedicated sections of this manual for further information).</li> <li>- If the voltage at the point of supply is much lower than that measured on the inverter, it is necessary to adjust the line (inverter-contactor).</li> <li>- If the voltage and the grid frequency come back within the limits (also when the inverter is connected to the grid), contact customer assistance</li> </ul>
- W005 - Grid UV -  Alarm LED	<b>Grid undervoltage:</b> This error signal occurs when during the inverter's normal operation the grid voltage exceeds the minimum limit set by the operator.	<ul style="list-style-type: none"> <li>• Check the grid voltage on the inverter.</li> <li>• Check the grid voltage also on the supply:</li> <li>- If it is high, it means that there is high grid impedance. In this case, ask the operator to adjust the grid voltage. If the operator authorises a change to the inverter's parameters, agree the new limits with customer assistance</li> <li>- If the voltage at the point of supply is much lower than that measured on the inverter, it is necessary to adjust the line (inverter-contactor).</li> <li>- If the voltage and the grid frequency come back within the limits (also when the inverter is connected to the grid), contact customer assistance</li> </ul>
- W006 - Grid OF -  Alarm LED	<b>Grid over-frequency:</b> This error signal occurs when during the inverter's normal operation the grid frequency exceeds the maximum limit set by the operator.	<ul style="list-style-type: none"> <li>• Check the grid frequency in the inverter.</li> <li>• Check the grid frequency also on the supply:</li> <li>-</li> <li>- If the voltage and the grid frequency come back within the limits (also when the inverter is connected to the grid), contact customer assistance</li> </ul>
- W007 - Grid UF -  Alarm LED	<b>Grid under-frequency:</b> This error signal occurs when during the inverter's normal operation the grid frequency exceeds the minimum limit set by the operator.	<ul style="list-style-type: none"> <li>• Check the grid frequency in the inverter.</li> <li>• Check the grid frequency also on the supply:</li> <li>-</li> <li>- If the voltage and the grid frequency come back within the limits (also when the inverter is connected to the grid), contact customer assistance</li> </ul>
- W010 * - Fan Fail -  Alarm LED flash.	<b>Fan Fail:</b> This error occurs when there is a malfunction in the fan/fans inside the inverter.	<ul style="list-style-type: none"> <li>• Error inside the inverter and cannot be checked externally.</li> <li>- If the alarm repeats persistently, contact customer assistance.</li> </ul>

- Error code - Error message - Signal	Name of Alarm and Cause	Solution
<ul style="list-style-type: none"> <li>- W011</li> <li>- Bulk UV</li> <li>-  Alarm LED</li> </ul>	<p><b>Low "Bulk" voltage (DC-DC circuit):</b> The alarm (which is a warning and not an error) is generated when the voltage at the heads of the bulk capacitors does not reach the threshold for the operation of the inverter (internal unchangeable threshold).</p>	<ul style="list-style-type: none"> <li>• Raise the value of the activation voltage (Vstart) if the problem at the time of the inverter's grid connection (Using the formulas <math>0,7 \cdot V_{mp, stc}</math> or <math>0,6 \cdot V_{oc, stc}</math>).</li> <li>• If the problem occurs in the morning, try to raise the value of the activation voltage (Vstart) (Using the formulas <math>0,7 \cdot V_{mp, stc}</math> or <math>0,6 \cdot V_{oc, stc}</math>).</li> <li>• Check the input voltage on the inverter.</li> <li>- If it does not exceed Vstart, check for the presence of sufficient irradiation and the correct composition of the system.</li> <li>- If it exceeds Vstart, contact customer assistance</li> </ul>
<ul style="list-style-type: none"> <li>- W012 *</li> <li>- Batt. Low</li> <li>-  Alarm LED</li> </ul>	<p><b>Battery Low:</b> The inverter displays the "Battery Low" message when it records a voltage for the buffer battery which is too low.</p>	<ul style="list-style-type: none"> <li>• Check that the date/time are set correctly and, if they are not, set them.</li> <li>Subsequently arrange to completely switch off the inverter (on both AC and DC) and wait a few minutes.</li> <li>Finally, restart the inverter and check whether the date/time are now correctly set or whether they have reset to 01/01/2000.</li> <li>In this case replace the battery with the inverter completely switched off (section AC and DC side) being careful to maintain the polarity</li> </ul>
<ul style="list-style-type: none"> <li>- W013 *</li> <li>- Clock Fail</li> <li>-  Alarm LED flash.</li> </ul>	<p><b>Clock Fail:</b> The alarm occurs when there is a difference of over 1 minute in the time displayed compared to the internal time of the microprocessors and indicates a malfunction of the clock circuit.</p>	<ul style="list-style-type: none"> <li>• completely switch off the inverter (on both AC and DC) and wait a few minutes.</li> <li>Finally, restart the inverter and check whether the date/time are now correctly set or whether they have reset to 01/01/2000.</li> <li>In this case replace the battery with the inverter completely switched off (section AC and DC side) being careful to maintain the polarity.</li> <li>- If the alarm repeats persistently, contact customer assistance.</li> </ul>
<ul style="list-style-type: none"> <li>- W015</li> <li>- Island Detect.</li> <li>-  Alarm LED</li> </ul>	<p><b>Disconnection due to Anti-Islanding:</b> The inverter has been improperly connected to an island grid.</p>	<ul style="list-style-type: none"> <li>• Check that the grid to which the inverter is connected is not an island grid.</li> <li>- If the grid to which the inverter is connected is an island grid, switch the inverter off and then on again: if the problem persists, contact customer assistance.</li> </ul>
<ul style="list-style-type: none"> <li>- W017*</li> <li>- String Err.</li> <li>-  Alarm LED flash.</li> <li>* (only for models with monitored string fuses)</li> </ul>	<p><b>Error recorded in measuring string currents:</b> Damaged string protection fuse(s)</p>	<ul style="list-style-type: none"> <li>• Check with a multimeter the state of the fuses (positioned on the fuse boards).</li> <li>- If one or more fuses is open, arrange to replace them and check that the input current on the string(s) does not exceed the rating of the fuses (should parallel strings have been made outside the inverter).</li> <li>- If there are no damaged string fuses and the inverter continues to show the alarm message check whether the settings to be made through the Aurora Manager software are correct (presence or absence of one or more input strings).</li> </ul>
<ul style="list-style-type: none"> <li>- W018 *</li> <li>- SPD DC Err</li> <li>-  Alarm LED flash.</li> <li>* (only for models with monitored SPD)</li> </ul>	<p><b>Intervention of overvoltage surge arresters on DC side:</b> Damaged overvoltage surge arresters positioned on DC side</p>	<ul style="list-style-type: none"> <li>• Observe the inspection window on each surge arrester (DC side). If it is red, the surge arrester is damaged and the cartridge must be replaced.</li> <li>- If the alarm status persists, even if all the surge arresters have a green inspection window, contact customer assistance.</li> </ul>
<ul style="list-style-type: none"> <li>- W019 *</li> <li>- SPD AC Err</li> <li>-  Alarm LED flash.</li> <li>* (only for models with monitored SPD)</li> </ul>	<p><b>Intervention of overvoltage surge arresters on AC side:</b> Damaged overvoltage surge arresters positioned on AC side</p>	<ul style="list-style-type: none"> <li>• Observe the inspection window on each surge arrester (AC side). If it is red, the surge arrester is damaged and the cartridge must be replaced.</li> <li>- If the alarm status persists, even if all the surge arresters have a green inspection window, contact customer assistance.</li> </ul>
<ul style="list-style-type: none"> <li>- W022 *</li> <li>- Reactive power mode changed</li> <li>-  No LED</li> </ul>	<p><b>Variation in means of managing reactive power:</b> Variation in the means of managing reactive power; this change can be made through the advanced configuration software.</p>	<p>The variation in the means of managing reactive power is done directly by the customer/installer and is not an error. The information is only saved on the historic record of the events memorised by the inverter</p>
<ul style="list-style-type: none"> <li>- W023 *</li> <li>- date/time changed</li> <li>-  No LED</li> </ul>	<p><b>Variation in the inverter's date and time:</b> Variation of the inverter's date and time; this change can be made through the advanced configuration software.</p>	<ul style="list-style-type: none"> <li>• The variation in the inverter's date and time is done directly by the customer/installer and is not an error. The information is only saved on the historic record of the events memorised by the inverter</li> </ul>
<ul style="list-style-type: none"> <li>- W024 *</li> <li>- Energy data reset</li> <li>-  No LED</li> </ul>	<p><b>Zeroing of the statistical energy data memorised in the EEPROM:</b> Reset of the energy data saved in the inverter; this operation can be handled through the advanced configuration software.</p>	<p>The zeroing of the partial energy values memorised by the inverter is done directly by the customer/installer and is not an error. The information is only saved on the historic record of the events memorised by the inverter</p> <ul style="list-style-type: none"> <li>• The notice may also occur on substitution of the Memory Card where the statistical production data is saved</li> </ul>
<ul style="list-style-type: none"> <li>- W026 *</li> <li>- AFDD user reset</li> <li>-  No LED</li> </ul>	<p><b>Reset of the Arc Fault error:</b> Manual reset of the Arc Fault error; this operation can be made through the advanced configuration software.</p>	<ul style="list-style-type: none"> <li>• The reset of the Arc Fault error is done directly by the customer/installer and is not an error. The information is only saved on the historic record of the events memorised by the inverter</li> </ul>

- Error code - Error message - Signal	Name of Alarm and Cause	Solution
- W027 * - Latch-Manual reset - ⊗ No LED	<b>Resetting of the Latch alarm conditions:</b> Manual reset of the Latch alarm conditions; this operation can be made through the advanced configuration software.	• The reset of the Latch alarm conditions is done directly by the customer/installer and is not an error. The information is only saved on the historic record of the events memorised by the inverter
- W046 - Grid conn. fault - ● Alarm LED	<b>Connection to the grid unsuccessful</b> The alarm is logged when a Missing grid or Input UV error occurs or due to the manual disconnection of the inverter during the grid connection sequence.	• Once the error occurs, the inverter tries to return to normal operation. If the problem persists after a number of attempts to connect the inverter, switch the inverter off and then on again. - If the problem persists (once the inverter has been switched off and back on again), contact customer assistance.
- W047 - Update Incomplete - ● Alarm LED	<b>FW update method unsuccessful</b> The alarm occurs when a firmware update has not been completed.	• Complete any pending firmware updates. - If the problem persists once the firmware updates have been completed, switch the inverter off and on again. - If the problem persists (once the inverter has been switched off and back on again), contact customer assistance.
- W048 - Periodic GridOff - ● Alarm LED	<b>Automatic disconnection from the grid due to time limit:</b> If the inverter exceeds the set grid connection time limit set by the grid standard, it will automatically have to carry out a disconnection and reconnection to the grid to carry out the Riso test.	• The presence of this alarm is not an error as the automatic disconnection is prescribed by safety regulations. - If the inverter disconnects in a shorter time than expected, contact customer assistance.
- W049 * - Global-Settings Event - ⊗ No LED	<b>Variation of the grid standard</b> Variation of the inverter's grid standard; this change can be made through the advanced configuration software.	• The variation in the inverter's grid standard is done directly by the customer/installer and is not an error. The information is only saved on the historic record of the events memorised by the inverter
- W058 - System Frozen - ● Alarm LED	<b>Converter in locked state:</b> The converter lock state is connected to an installation phase in which the starts-up and grid connection conditions are not yet present.	• Complete the commissioning phase of the inverter. - If the problem persists (once the commissioning phase has been completed and the inverter has been switched off and back on again), contact customer assistance.
- E001 - Input OC - ● Alarm LED	<b>Input over-current (photovoltaic generator):</b> The alarm occurs when the inverter's input current exceeds the inverter's threshold for maximum input current.	• Check whether the composition of the PV generator enables input current which exceeds the maximum threshold allowed by the inverter and that the configuration of the inputs (independent or in parallel) is carried out correctly. - If both checks are positive, contact customer assistance.
- E002 - Input OV - ● Alarm LED	<b>Input overvoltage (photovoltaic generator):</b> The alarm is generated when the input voltage (from the PV generator) exceeds the inverter's threshold of maximum input voltage. The alarm occurs before reaching the absolute threshold over which the inverter is damaged.  When the inverter's input voltage exceeds the overvoltage threshold, the inverter will not start up due to the generation of the alarm.	• It is necessary to measure the input voltage inside the inverter with a voltmeter. - If it is higher than the maximum voltage of the operating range, the alarm is genuine and it is necessary to check the configuration of the PV generator. If the voltage has also exceeded the maximum input threshold the inverter could be damaged. - If it is lower than the maximum voltage of the operating range, the alarm is caused by an internal malfunction and it is necessary to contact customer assistance.
- E003 - No Parameters - ● Alarm LED	<b>DSP initialisation error:</b> The main microcontroller cannot initialise correctly the two DSPs (booster stage and inverter stage). The error is caused by communication problems on the inverter's internal bus.	• Error inside the inverter and cannot be checked externally. - If the problem persists (once the inverter has been switched off and back on again), contact customer assistance.
- E004 - Bulk OV - ● Alarm LED	<b>“Bulk” over-voltage (DC-DC circuit):</b> Error inside the inverter. The alarm is raised when the voltage at the heads of the bulk capacitors exceeds the overvoltage threshold (internal unchangeable threshold).	• The alarm may be triggered by causes external to the inverter: - An excessive input voltage can be recorded as a condition for bulk overvoltage. In this case it is advisable to check the inverter's input voltage and should this value be close to the input OV threshold, review the configuration of the photovoltaic generator. - Excessive grid voltage could cause the bulk voltage to rise in uncontrolled fashion with a consequent protection intervention and hence generation of the alarm. In these cases the alarm is transitory and the inverter automatically restarts - The alarm may be triggered by causes inside the inverter and in this case it is necessary to contact customer assistance.
- E005 - Comm.Error - ● Alarm LED	<b>Communication error inside the inverter:</b> The alarm occurs when there are communication problems between the control devices inside the inverter.	• Error inside the inverter and cannot be checked externally. - If the problem (once the inverter has been switched off and back on) persists, contact customer assistance.
- E006 - Output OC - ● Alarm LED	<b>Output overcurrent:</b> The alarm occurs when the inverter's output current exceeds the inverter's threshold for maximum output current.	• Error inside the inverter and cannot be checked externally. - If the problem (once the inverter has been switched off and back on) persists, contact customer assistance.

- Error code - Error message - Signal	Name of Alarm and Cause	Solution
- E007 - IGBT Sat -  Alarm LED	<b>Saturation recorded on the IGBT components:</b> The alarm occurs when one of the inverter's active devices is in a saturated state.	Once the error occurs, the inverter tries to return to normal operation. - Should the error occur sporadically, it may be caused by a brusque transition of the grid voltage or of the input voltage, but is not due to a malfunction by the inverter. - If the error is connected to an internal breakdown, it will continue to appear and so it is necessary to contact customer assistance.
- E009 - Internal error -  Alarm LED	<b>Error inside the inverter:</b> Error inside the inverter	• Error inside the inverter and cannot be checked externally. - If the problem (once the inverter has been switched off and back on) persists, contact customer assistance.
- E010 - Bulk Low -  Alarm LED	<b>Low "Bulk" voltage (DC-DC circuit):</b> The alarm may be triggered by causes external to the inverter: a reduced input voltage on the inverter (just above the activation voltage) but which is not accompanied by a sufficient availability of power from the photovoltaic generator (typical condition of the stages with limited irradiation)	- If the error signal occurs sporadically, it may be due to causes external to the inverter (limited irradiation and so limited power availability from the PV generator). - If the problem occurs systematically also in conditions of high irradiation and with input voltage which is significantly higher than the activation voltage, contact customer assistance.
- E011 - Ramp Fail -  Alarm LED	<b>Long wait for "Booster" regime to start:</b> Error internal to inverter relating to start up time for DC-DC circuit regime (Booster)	• Error inside the inverter and cannot be checked externally. - If the problem (once the inverter has been switched off and back on) persists, contact customer assistance.
- E012 - DcDc Fail -  Alarm LED	<b>Error in the "Booster" circuit (DC-DC side) recorded by the "Inverter" circuit (DC-AC side):</b> Error internal to inverter relating to operation of the DC-DC circuit regime (Booster)	• Error inside the inverter and cannot be checked externally. - If the problem persists (once the inverter has been switched off and back on again), contact customer assistance.
- E013 - Wrong Mode -  Alarm LED	<b>Incorrect configuration of inputs (set in parallel rather than independent):</b> The alarm is generated solely when the inverter is configured with parallel inputs. In this particular configuration the inverter checks the input voltage of each of the two channels and if the two voltages differ by more than 20Vdc, the alarm is raised .	• Check that the setting of the "IN MODE" switch is specifically set to "PAR" and that the bridges between the two input channels have been included. - If the configuration of the inverter is correct, check that the input strings have the usual number of standard panels of the usual brand and with the same inclination/orientation. - If both the configuration of the inverter and the characteristics of the PV generator conform with the specifications, contact customer assistance.
- E014 - Over Temp. -  Alarm LED	<b>Excessive temperature inside the inverter:</b> External temperature over 60°C. This parameter also depends on the power which the inverter must supply since the measurement of temperatures is done internally and is influenced by the heat dissipated by the components of the inverter itself	• Check that the inverter is not exposed to direct sunlight. Wait for the temperatures to which the inverter is exposed to return to the operating range and for the inverter to cool down. - If the problem (once the ambient temperature has returned to the range) persists, contact customer assistance. Remember to wait the time needed to allow the inverter to cool down
- E015 - Bulk Cap Fail -  Alarm LED	<b>Fault recorded on the "Bulk" capacitor:</b> Error inside the inverter relating to a problem in the bulk capacitors.	• Error inside the inverter and cannot be checked externally. - If the problem persists (once the inverter has been switched off and back on again), contact customer assistance.
- E016 - Inverter Fail -  Alarm LED	<b>Error in the "Inverter" circuit (DC-AC side) recorded by the "Booster" circuit (DC-DC side):</b> The alarm is generated when a problem is recorded in the inverter circuit (DC/AC)	• Error inside the inverter and cannot be checked externally. - If the problem persists (once the inverter has been switched off and back on again), contact customer assistance.
- E017 - Start Timeout -  Alarm LED	<b>Long wait for "Inverter" regime to start up:</b> Error internal to inverter relating to start-up time for the DC-AC circuit regime (Inverter) • The alarm may be triggered by causes external to the inverter: a reduced input voltage on the inverter (just above the activation voltage) but which is not accompanied by a sufficient availability of power from the photovoltaic generator (typical condition of the stages with limited irradiation)	- If the error signal occurs sporadically, it may be due to causes external to the inverter (limited irradiation and so limited power availability from the PV generator). - If the problem occurs systematically also in conditions of high irradiation and with input voltage which is significantly higher than the activation voltage, contact customer assistance.
- E018 - Ground Fault -  GFI LED	<b>High leakage current measured on the DC side (photovoltaic generator):</b> The alarm is generated when, during normal operation of the inverter, a leakage current to ground is detected in the DC section of the system. It is also possible that the inverter generates the alarm E018 message also due to AC leakage currents connected to the capacitive nature of the photovoltaic generator compared to ground.	• Measure the insulation resistance using a megohmmeter positioned in the photovoltaic field (positive terminal short-circuited at the negative pole) compared to ground. The measurement is strongly influenced by the environmental conditions, so must be made under the same conditions in which the error occurred. - If the value measured is lower than 1 megaohm, a check must be carried out by a technician/installer on the photovoltaic generator to identify and eliminate the problem. - If the value measured is higher than 1 megaohm and the error signal persists, contact customer assistance.

- Error code - Error message - Signal	Name of Alarm and Cause	Solution
- E019 - Ileak sense.fail - ● Alarm LED	<b>Failure of test on sensor to measure the leakage current (DC side):</b> Before connecting to the grid the inverter runs a autotest regarding the sensor for the leakage current. The test is carried out by "forcing", in the sensor of the leakage current, a current with a known value: the microprocessor compares the value read with the known value. The error is generated if the comparison between the read value and the known value during the test does not fall within the allowed tolerance.	<ul style="list-style-type: none"> <li>• Error inside the inverter and cannot be checked externally. By its nature, the alarm only occurs prior to connection to the grid</li> <li>- If the problem (once the inverter has been switched off and back on) persists, contact customer assistance.</li> </ul>
- E020 - Self Test Error 1 - ● Alarm LED	<b>Failure of the test on the relay of the "Booster" (DC-DC circuit):</b> Before connecting to the grid the inverter carries out internal tests. One of these tests concerns the correct operation of the booster relay. The test is carried out by "forcing" the switching of the relay and checking its operation. The error is generated if a problem is found in actioning the relay.	<ul style="list-style-type: none"> <li>• Error inside the inverter and cannot be checked externally. By its nature, the alarm only occurs prior to connection to the grid</li> <li>- If the problem persists (once the inverter has been switched off and back on again), contact customer assistance.</li> </ul>
- E021 - Self Test Error 2 - ● Alarm LED	<b>Failure of the test on the inverter's relay (DC-AC circuit):</b> Before connecting to the grid the inverter carries out internal tests. One of these tests concerns the correct operation of the inverter relay. The test is carried out by "forcing" the switching of the relay and checking its operation. The error is generated if a problem is found in actioning the relay.	<ul style="list-style-type: none"> <li>• Error inside the inverter and cannot be checked externally. By its nature, the alarm only occurs prior to connection to the grid</li> <li>- If the problem persists (once the inverter has been switched off and back on again), contact customer assistance.</li> </ul>
- E022 - Self Test Error 4 - ● Alarm LED	<b>Timeout of the tests undertaken on the relays inside the inverter:</b> Execution time for the autotest carried out on the relay of the DC_AC (inverter) circuit too high. It may indicate a problem connected to the aforementioned relays	<ul style="list-style-type: none"> <li>• Error inside the inverter and cannot be checked externally.</li> <li>- If the problem persists (once the inverter has been switched off and back on again), contact customer assistance.</li> </ul>
- E023 - DC in error - ● Alarm LED	<b>Feeding of direct current to grid outside of range:</b> The error is generated if the continuous component of the current supplied to the grid exceeds the threshold of 0.5% of the normal operating current. In any case the inverter is not blocked due to the E023 error, but tries to reconnect to the grid. The sporadic repetition of the error is a sign of serious grid distortions or sharp irradiation changes, while systematic repetition of the error signal will indicate a breakdown on the inverter	Once the error occurs, the inverter tries to return to normal operation. - Should the error occur sporadically, it may be caused by a brusque transition of the grid voltage or of the input voltage, but is not due to a malfunction by the inverter. - If the error is connected to an internal breakdown, it will continue to appear and so it is necessary to contact customer assistance.
- E024 - Internal error - ● Alarm LED	<b>Error inside the inverter:</b> Error inside the inverter	<ul style="list-style-type: none"> <li>• Error inside the inverter and cannot be checked externally.</li> <li>- If the problem persists (once the inverter has been switched off and back on again), contact customer assistance.</li> </ul>
- E025* - Riso Low - ● Alarm LED	<b>Low value of insulation resistance:</b> Before connecting to the grid the inverter measures the insulation resistance of the PV generator compared to ground. Should the measurement of the insulation resistance be below 1Mohm, the inverter does not connect to the grid and shows the "Riso Low" error. The causes may be: - PV panel(s) damaged; - Junction box(es) of the panels not correctly sealed, so as to permit infiltration by water and/or humidity; - Problems in connections between panels (not perfectly fit); - Poor quality of cable joints; - Presence in the DC section of unsuitable or damaged overvoltage surge arresters outside the inverter (reduced ignition voltage compared to the characteristics of the strings of the PV generator); - Presence of humidity inside any junction box	<ul style="list-style-type: none"> <li>• Measure the insulation resistance using a megohmmeter positioned in the photovoltaic field (positive terminal short-circuited at the negative pole) compared to ground. The measurement is strongly influenced by the environmental conditions, so must be made under the same conditions in which the error occurred.</li> <li>- If the value measured is lower than 1 megaohm, a check must be carried out by a technician/installer on the photovoltaic generator to identify and eliminate the problem.</li> <li>- If the value measured is higher than 1 megaohm and the error signal persists, contact customer assistance.</li> </ul>
- E026 - Vref Error - ● Alarm LED	<b>Internal reference voltage outside of range:</b> Wrong measurement of reference voltage inside inverter	<ul style="list-style-type: none"> <li>• Error inside the inverter and cannot be checked externally.</li> <li>- If the problem persists (once the inverter has been switched off and back on again), contact customer assistance.</li> </ul>
- E027 - Error Meas V - ● Alarm LED	<b>Grid voltage outside of range:</b> Error in the internal measurement of grid voltage (set by law) in order to have a redundant measurement (2 measurements on the same parameter made by two different circuits)	<ul style="list-style-type: none"> <li>• Error inside the inverter and cannot be checked externally.</li> <li>- If the problem persists (once the inverter has been switched off and back on again), contact customer assistance.</li> </ul>

- Error code - Error message - Signal	Name of Alarm and Cause	Solution
- E028 - Error Meas F - ☉ Alarm LED	<b>Grid frequency outside of range:</b> Error in the internal measurement of grid frequency (set by law) in order to have a redundant measurement (2 measurements on the same parameter made by two different circuits)	• Error inside the inverter and cannot be checked externally. - If the problem persists (once the inverter has been switched off and back on again), contact customer assistance.
- E029 - Mid Bulk OV - ☉ Alarm LED	<b>Internal overvoltage on the measurement of the “Mid bulk”:</b> Error inside the inverter (only triphase models)	• Error inside the inverter and cannot be checked externally. - If the problem persists (once the inverter has been switched off and back on again), contact customer assistance.
- E030 - Error Meas Ileak - ☉ Alarm LED	<b>High leakage current (DC side):</b> Error in the internal measurement (made when the inverter is grid connected) of the leakage current of the DC side (PV generator) compared to ground (set by law) in order to have a redundant measurement (2 measurements on the same parameter made by two different circuits)	• Error inside the inverter and cannot be checked externally. - If the problem persists (once the inverter has been switched off and back on again), contact customer assistance.
- E031 - Error Read V - ☉ Alarm LED	<b>Output relay damaged:</b> Measurement of internal voltage on heads of the output relay outside of range. There is too great a difference in voltage between the input and output of the grid connection relay.	• Error inside the inverter and cannot be checked externally. - If the problem persists (once the inverter has been switched off and back on again), contact customer assistance.
- E032 - Error Read I - ☉ Alarm LED	<b>Imbalanced output currents:</b> Measurement of the imbalance in the output voltage (carried out across the three phases) outside of range (only in triphase models)	• Error inside the inverter and cannot be checked externally. - If the problem persists (once the inverter has been switched off and back on again), contact customer assistance.
- E033 - UTH - ☉ Alarm LED	<b>Low ambient temperature:</b> Temperature outside the inverter below -25°C	• Wait for the temperatures to which the inverter is exposed to return to the operating range. - If the problem persists, contact customer assistance. Remember to wait the time needed to allow the inverter to warm up
- E034 - Interlock fail - ☉ Alarm LED	<b>“IGBT” circuitry not ready:</b> Error inside the inverter	• Error inside the inverter and cannot be checked externally. - If the problem persists (once the inverter has been switched off and back on again), contact customer assistance.
- E035* - Remote Off - ☉ Alarm LED	<b>Inverter awaiting “remote ON” command:</b> The inverter has been switched off remotely (remote OFF) and remains awaiting the signal which will switch it back on (Remote ON)	• Switch the inverter back on remotely. If the unit does not switch back on, disable the remote off/on function and switch the equipment off completely and subsequently switch it back on. - If the problem persists, contact customer assistance.
- E036 - Vout Avg error - ☉ Alarm LED	<b>Average of the measurements of grid voltage outside of range:</b> The average value of the grid voltage (sampled every 10 minutes) does not fall within the permitted ranges. The grid voltage in the point connected to the inverter is too high. This may be caused by too high a grid impedance. In the final stage of the timeout, the inverter limits the power to check whether the grid voltage has stabilised into regular parameters. If this does not happen, the inverter disconnects from the grid	• Check the grid voltage in the connection point to the inverter. - If the grid voltage differs from the range due to the conditions of the distribution grid, ask the operator to adjust the grid voltage. If the operator authorises a change to the inverter’s parameters, agree the new limits with customer assistance
E046 - String self test fail - ⊗ No LED	<b>Error during the automatic check of the string voltages (only in models with the “fuse-control” board):</b> In some inverter models it is possible to carry out the check test of the polarity of the strings connected to the input (e.g.:TRIO-20.0/27.6kW). This error signal occurs when, during the test stage, an inverted string is recorded	• Section the inverter and check the polarity of the string(s) which the inverter has recorded as inverted. - Once all the strings have been correctly connected, activate the system once again; the inverter will once again check the correct polarity of the string inputs at the end of which it will carry out the checks for the grid connection. - If the problem persists (once the inverter has been switched off and back on again), contact customer assistance.
E049 - AC FF Error - ☉ Alarm LED	<b>Error in the “AC feed-forward” circuit:</b> Error inside the inverter	• Error inside the inverter and cannot be checked externally. - If the problem persists (once the inverter has been switched off and back on again), contact customer assistance.
E050 - AFDD Activated - ● GFI LED	<b>Arc Fault protection activated:</b> Possible photovoltaic arc detected on the DC side.	• If it is the first time this problem has occurred, press the ESC button for 5 seconds and wait for the unit to restart. - If the problem persists (once the inverter has been switched off and back on again), contact customer assistance.
E053 - AFDD Fault - ☉ Alarm LED	<b>Arc Fault board autotest failed:</b> Problem detected during the AFDD board autotest phase.	• Error inside the inverter and cannot be checked externally. - If the problem persists (once the inverter has been switched off and back on again), contact customer assistance.
E054 - AFDD comm. Fault - ☉ Alarm LED	<b>Arc Fault board communication error:</b> Error on the RS485 serial communication detected between the inverter and the AFDD board.	• Error inside the inverter and cannot be checked externally. - If the problem persists (once the inverter has been switched off and back on again), contact customer assistance.

- Error code - Error message - Signal	Name of Alarm and Cause	Solution
<b>E055</b> - <b>AFDD wrong conf.</b> - Alarm LED	<b>Arc Fault board parameter reading error:</b> Error in the parameter reading by the system.	<ul style="list-style-type: none"> <li>• Error inside the inverter and cannot be checked externally.</li> <li>- If the problem persists (once the inverter has been switched off and back on again), contact customer assistance.</li> </ul>
<b>E056</b> - <b>Over Temp. (from external box)</b> - Alarm LED	<b>Excessive temperature measured inside the inverter's wiring box:</b> High internal temperature. This error relates to the temperature measured on external boxes (e.g.:TRIO-20.0/27.6kW).	<ul style="list-style-type: none"> <li>• Check that the inverter is not exposed to direct sunlight. Wait for the temperatures to which the inverter is exposed to return to the operating range and for the inverter to cool down.</li> <li>- If the problem (once the ambient temperature has returned to the range) persists, contact customer assistance. Remember to wait the time needed to allow the inverter to cool down</li> </ul>
<b>E057</b> - <b>Vbulk reading error</b> - Alarm LED	<b>Input voltage (Vin) higher than booster voltage (Vbulk):</b> The error occurs if the input voltage exceeds the Bulk voltage (voltage on the DC-DC circuit inside the inverter)	<ul style="list-style-type: none"> <li>• It is necessary to measure the input voltage inside the inverter with a voltmeter.</li> <li>- If it is higher than the maximum voltage of the operating range, the alarm is genuine and it is necessary to check the configuration of the PV generator. If the voltage has also exceeded the maximum input threshold the inverter could be damaged.</li> <li>- If it is lower than the maximum voltage of the operating range, the alarm is caused by an internal malfunction and it is necessary to contact customer assistance.</li> </ul>
<b>E058</b> - <b>Pin vs Pout check error</b> - Alarm LED	<b>Error in the check of Pin vs Pout:</b> The error occurs if the difference between the measured value of input power and that of output power is greater than the limit imposed internally to the inverter.	<ul style="list-style-type: none"> <li>• Error inside the inverter and cannot be checked externally.</li> <li>- If the problem persists (once the inverter has been switched off and back on again), contact customer assistance.</li> </ul>
<b>E077</b> - <b>Internal Error</b> - Alarm LED	<b>Error in the system configuration:</b> Error inside the inverter	<ul style="list-style-type: none"> <li>• Error inside the inverter and cannot be checked externally.</li> <li>- If the problem persists (once the inverter has been switched off and back on again), contact customer assistance.</li> </ul>
<b>E078</b> - <b>Riso Test fail</b> - Alarm LED	<b>Riso test error:</b> Problem detected during the Riso test phase.	<ul style="list-style-type: none"> <li>• Error inside the inverter and cannot be checked externally.</li> <li>- If the problem persists (once the inverter has been switched off and back on again), contact customer assistance.</li> </ul>
<b>E079</b> - <b>Wrong Sequence</b> - Alarm LED	<b>Incorrect Phases connection</b> (Only triphase models) The phases have not been connected correctly to the AC output	<ul style="list-style-type: none"> <li>• Invert two of the phases of the network wiring to the AC terminal block of the inverter.</li> </ul>
<b>E084</b> - <b>BackFeed OC</b> - Alarm LED	<b>Return current to photovoltaic field:</b> The error occurs if the input voltage is particularly low (typically in the evening in conditions of low irradiation) and indicates a return current from the inverter to the photovoltaic panels).	<ul style="list-style-type: none"> <li>• If the error occurs in the evening or in conditions of low irradiation, it must not be considered a problem but a protection intervention for the photovoltaic field.</li> <li>- If the problem occurs with good irradiation conditions, switch the inverter off and back on again; if the error persists, contact customer assistance.</li> </ul>

## Power limitation messages

The equipment can signal possible output power limitations which may occur on the basis of:

- settings made by the user
- settings required by the grid standard of the country of installation
- protective devices inside the inverter

The limitation messages can only be verified on the Web User Interface on "Status Summary" section.



## Dismantling the inverter



Before attempting any work on the inverter, wait for stored energy to be discharged and for parts to cool.

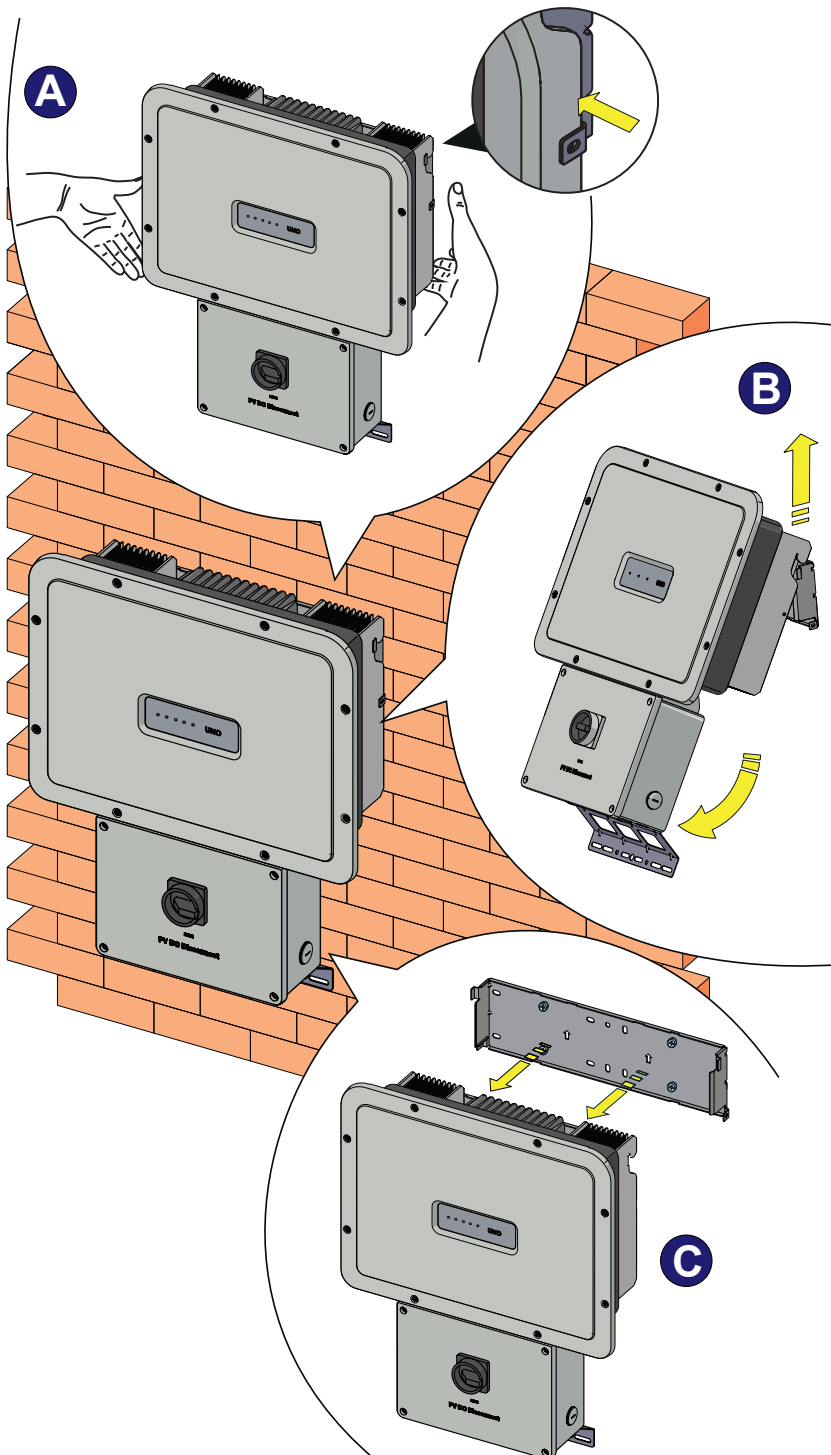

- Open the external DC and AC disconnects switches.
- Disconnect any power supplies that may be connected to the UNO-DM-COM KIT or UNO-DM-PLUS-ETHERNET COM KIT.
- Disconnect any cables from the inverter:
  - DC cables
  - AC cables
  - Any cables that may be connected to the UNO-DM-COM KIT or UNO-DM-PLUS-ETHERNET COM KIT
- Disconnect any conduits from the inverter.
- Remove the screw on the lower bracket used to secure the inverter to the wall or frame.
- Remove the two side screws (figures **A** and **B**). Pulling forward the lower part of the inverter (figures **A** and **B**).
- Remove the inverter from the wall bracket pulling it up (figures **B** and **C**).

## Calculation of second-level password (Service menu, Admin Plus)

In order to obtain the second-level password needed to access the inverter's display service menu or to obtain the "Admin Plus" privileges in the internal webserver, contact FIMER Technical Sales (1-877-261-1374) keeping the following information on hand:

- **S/N** - Serial number of the inverter. This information can be found on the product label giving the identity details of the inverter.

The serial number consists of 6 digits (the last 6 in models with a label giving a 10-digit S/N)

- **WK** - Production week. This information can be found on the product label giving the identity details of the inverter.

The production week consists of 4 figures, indicating the week (first 2 digits) and the year of production (last 2 digits)

- **Update Version** - This information is available only for some inverter models and can be found by accessing the internal webserver.



*The password obtained enables access also to the advanced "Admin" mode of the internal web server.*

## Replacement of the MEMORY board



Some inverter parts may be subject to voltages that could be hazardous for the operator. **Before performing any work on the inverter, refer to “Inverter total de-energization and safe access” chapter on this manual to know all the necessary step to safely operate on the inverter.**

Replacing the MEMORY board may be necessary in the following circumstances:

**Inverter log Statistic (e.g. power production) lost after system shutdown.**

The MEMORY board is installed on the logic board inside the inverter in the position shown in the picture below (red highlighted).

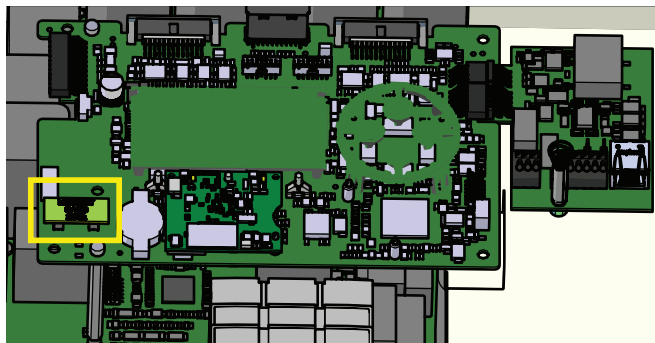

Procedure to replace the MEMORY board:

1. Follow all indication in the “Inverter total de-energization and safe access” chapter on this manual to secure the inverter.
2. Remove the MEMORY board to be replaced.
3. Install the new MEMORY board paying attention to insert with the right side (the “MEMORY CARD” text have to be upside down).
4. Close the front cover **04**.
5. Reconnect all the input strings and start the inverter.

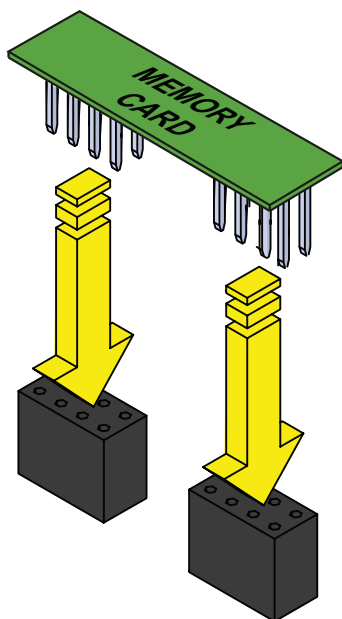

## Replacement of the buffer battery



Some inverter parts may be subject to voltages that could be hazardous for the operator. **Before performing any work on the inverter, refer to “Inverter total de-energization and safe access” chapter on this manual to know all the necessary step to safely operate on the inverter.**

Replacing the buffer battery may be necessary in the following circumstances:

1. LED error signal
2. Reset of the date and time settings

The battery is of the **CR2032 type** and is installed on the logic board inside the inverter in the position shown in the picture below (red highlighted).

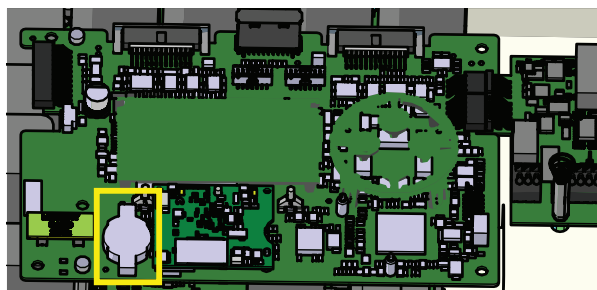

Procedure to replace the buffer battery:

1. Follow all indication in the “Inverter total de-energization and safe access” chapter on this manual to secure the inverter.
2. Using a flat screwdriver gently remove the buffer battery to be replaced.
3. Install the new battery, taking care to handle it with insulating gloves in order not to compromise the charge and respecting the polarity (the positive need to be on the top side).
4. Close the front cover **04**.
5. Reconnect all the input strings and start the inverter.

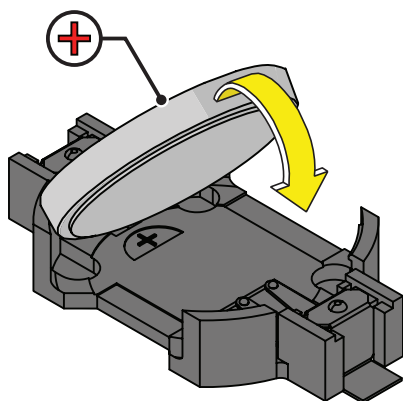

## Verification of ground leakage

In the presence of anomalies or report of ground fault (where provided), there may be a ground leakage from the PV generator (DC side).

To check this, measure the voltage between the positive pole and ground and between the negative pole (of the PV generator) and ground using a voltmeter whose input accepts a voltage of at least 1000 Volts.

### Behavior of a system without leakage

Due to the capacitive effect of the PV generator, during the first moments that the voltmeter is connected between one of the two poles and ground, it will measure a voltage of about  $V_{oc}/2$ , which will tend to stabilize to around 0V if there is no ground leakage, as shown in the graph below:

The internal resistance of the voltmeter tends to zero the voltage present on the PV generator due to the capacitive effect.

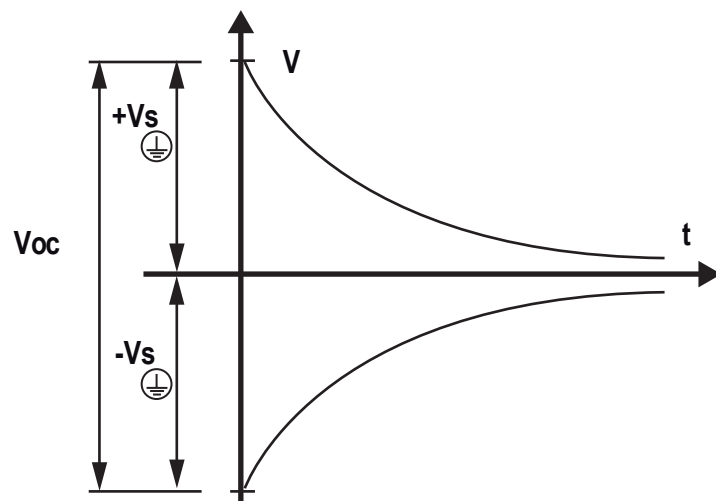

How to make the measurement:

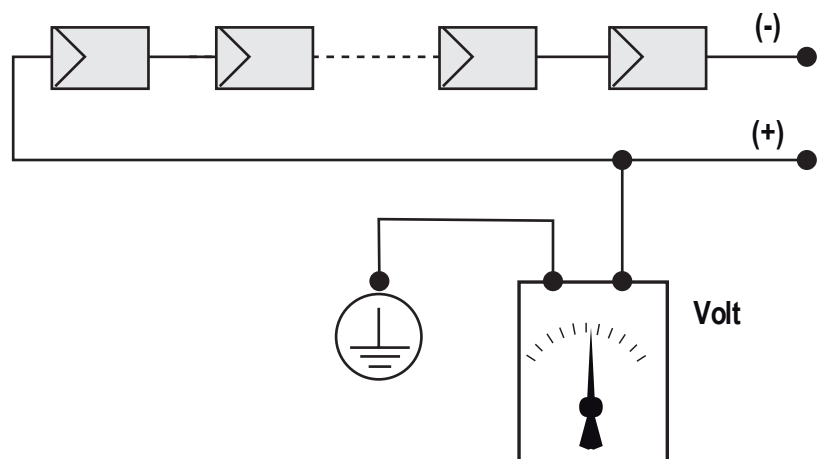

## Behavior of a system with leakage

If the voltage measured between one of the two poles and ground does not tend to 0V and stabilizes on a value, there is a ground leakage from the PV generator.

Example: When the measurement is made between positive pole and ground, a voltage of 200V is measured.

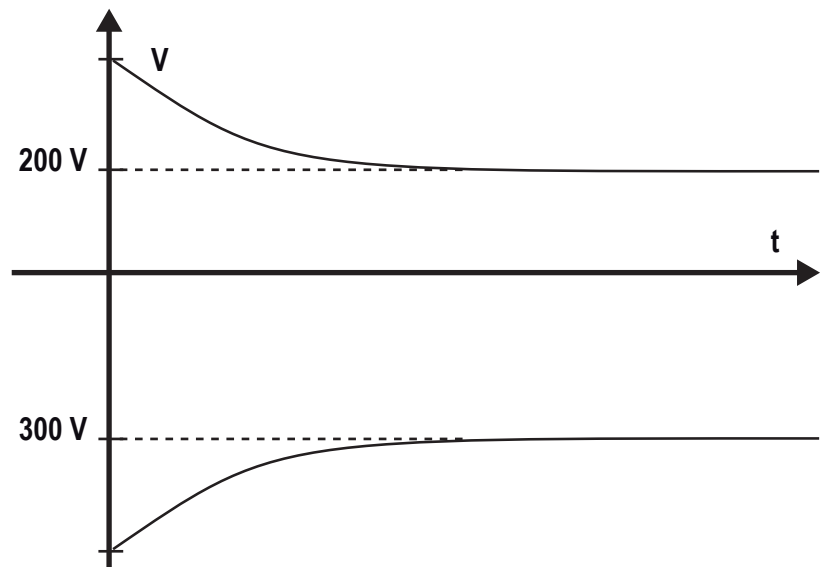

This means that if the system is made up of 10 modules in series and each one supplies 50V, the leakage can be located between the 4th and 5th PV module.

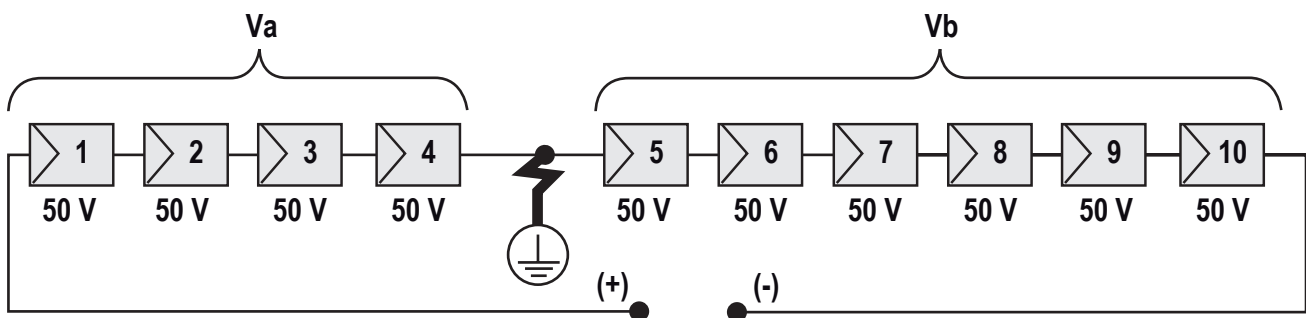

$V_a$  = voltage measured between + pole and  $\oplus$  = 200V

$V_b$  = voltage measured between - pole and  $\oplus$  = 300V

In all measurements with  $\oplus$ , the ground of the inverter is indicated.

## Measuring the insulation resistance of the PV generator.

To measure the insulation resistance of the PV generator compared to ground (⊕), the two poles of the PV generator must be short-circuited (using a suitably sized selector).

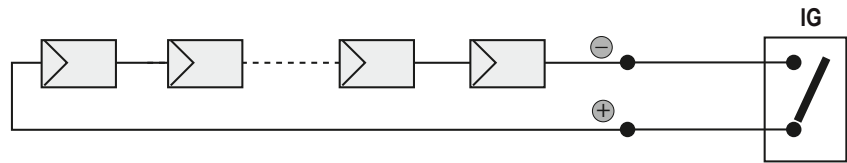

Once the short-circuit has been made, measure the insulation resistance (Riso) using a megohmmeter positioned between the two shorted poles and ground (of the inverter).

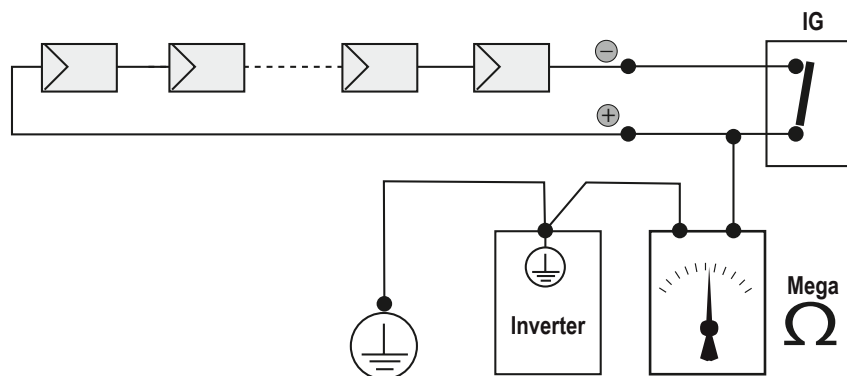

**MODELS - TL (without insulation transformer).** If the measured insulation resistance (Riso) is less than 500 MOhm, the inverter may not connect to the grid because of low insulation of the PV generator to ground.

**MODELS - I (with insulation transformer).** If the measured insulation resistance (Riso with floating input poles compared to ground or QF=1 with grounding of one of the two inlet poles) is lower than 0.2 MOhm, the inverter will not connect to the grid due to low insulation of the PV generator to ground.

*The insulation resistance can be affected by the environmental conditions the PV generator is in (E.g.: PV modules wet from damp or rain), and therefore the measurement must be made immediately after the anomaly is detected*

## Storage and dismantling

### Storage of an uninstalled inverter for long periods

If the inverters to be stored for a long period of time before installation, check that it is correctly packed.

The equipment must be stored in well-ventilated, indoor areas, in a non-corrosive environment that doesn't damage the inverter's components.

Have the inverter inspected before installation: interior components, covers and gaskets.

### Storage of an installed inverter for long periods of non-use

If an inverter in the field is to be left unused, confirm all external openings and connectors have water tight seals or cap. Securely close all locks. If it's in a humid environment, install dessicant in the interior since the inverter is not seeing heat cycles each day.

Restarting after a long period of non-use requires a thorough inspection of the inverter's interior, exterior and wiring to the PV field and grid (and removal of any dessicant). In some cases, oxidation and dust that has settled inside the equipment must be removed.

## Disposal

FIMER CANNOT be held responsible for disposal of the equipment (cables, batteries, etc.). The customer must dispose of these items, some of which be harmful to the environment, in accordance with the local regulations

Dispose of the various types of materials at facilities that are suitable for the purpose.

**Table: component composition**

<b>COMPONENT</b>	<b>CONSTRUCTION MATERIAL</b>
Frame, brackets, supports .....	Arc-welded steel FE37
Casing or covers .....	Arc-welded steel FE37, aluminum
Gaskets and seals .....	Rubber / Teflon / Viton
Electrical cables .....	Copper / Rubber
Backup battery .....	Nickel / Lead/ Lithium



## Port and network services used by the inverter

### IP Network Services

Any network connected to the inverter must allow traffic to pass on the following ports. Network firewall rules (if present) must allow responses to the inverter over existing TCP connections.

Direction	Service/Port	Protocol	Description
In	ssh/22	Tcp	For local debugging by FIMER service personnel, the inverter utilizes encrypted SSH. To allow service personnel local access to the inverter.
Out	domain/53	Tcp/udp	The inverter must be able to resolve domain names, to ensure scalability and dynamic changes on the Internet (DNS). (required)
Out	https/443	Tcp	As an HTTP client, the inverter uses SSL/TLS protocol connections to Aurora Vision® servers for secure communication. The inverter uses this port for all services, including data transmission, firmware upgrade, configuration management, and remote command transmission. (required)
Out	dhcp/67, dhcp/68	Udp	If DHCP service is not available, static network information must be assigned to the inverter (preferred)
Out	ntp/123	Udp	The inverter uses this port for network time services (NTP). (preferred)
Out	modbus/502	Tcp	The inverter offer a Modbus TCP server connection on this port.
Out	dns-sd/5353	Udp	The inverter uses this protocol to resolve the local IP address.
Out	http/80	Tcp	As an HTTP client, the inverter uses this protocol to offer local connection.

## Network Hosts

The inverter will connect to the following hosts. Some servers owned by FIMER, and others are customer or ISP servers. Servers listed as owned by "Customer IT/ISP" must be configured in the inverter using either DHCP or as static network information.

Host	Purpose	Port	Owner/Manager
platform.auroravision.net	Data, configuration	TCP:443	FIMER
gw1.auroravision.net and/or apt.fatspaniel.net	Inverter firmware upgrade	TCP:443	FIMER
Site dependent	DHCP (optional)	UDP:67, UDP:68	Customer IT/ISP
Site dependent	DNS	UDP:53, TCP:53	Customer IT/ISP

## Inverter network configuration

The inverter requires a valid network configuration in order to operate. This information can either be provided by a DHCP server provided by the customers network (the default), or the inverter can be configured with static network information. Regardless of how the inverter is configured, the following information is required.

Configuration	Purpose
IP Address	Allows the inverter to take part in the local network. This does not need to be a public IP address. In most cases this is a private IP address.
Subnet mask	Used to determine if two computers are on the same network.
Gateway	The IP address of the computer which will forward network traffic from the local network to an external network
DNS Server	The IP address(es) of the computer(s) which resolve domain names.

## Contact us

[www.fimer.com](http://www.fimer.com)



For more information  
please contact  
your local FIMER  
representative or visit:

[fimer.com](http://fimer.com)

We reserve the right to make technical changes or modify the contents of this document without prior notice. With regard to purchase orders, the agreed particulars shall prevail. FIMER does not accept any responsibility whatsoever for potential errors or possible lack of information in this document.

We reserve all rights in this document and in the subject matter and illustrations contained therein. Any reproduction, disclosure to third parties or utilization of its contents – in whole or in parts – is forbidden without prior written consent of FIMER. Copyright© 2020 FIMER. All rights reserved.