

FIMER



Solar Inverter

PVS-10/12.5/15-TL

Quick Installation Guide

In addition to what is explained in this quick installation guide, the safety and installation information provided in the product manual must be read and followed. The technical documentation for the product is available at the website.

The device must be used in the manner described in the manual. If this is not the case the safety devices guaranteed by the inverter might be ineffective.

**APPLY HERE
THE COMMUNICATION
IDENTIFICATION LABEL**

1. Inverter models and components

This Quick Installation Guide is related to the following inverter models:

Inverter model	Input MPPTs	DC switch	DC SPD	DC connection	AC SPD	AC connection
PVS-10-TL-SX	2	Yes	Type 2	4 input strings	Type 2	AC quick fit connector
PVS-12.5-TL-SX						
PVS-15-TL-SX						
PVS-10-TL-SY	2	Yes	Type 1+2	4 input strings	Type 2	AC quick fit connector
PVS-12.5-TL-SY						
PVS-15-TL-SY						

The -SX inverter models can be equipped with the following options:

Option	Description
.APD inverter model suffix	• Inverter equipped with PID recovery functionality
.AFD inverter model suffix	• Inverter equipped with Arc Fault Detection functionality
.DISPLAY inverter model suffix	• Inverter equipped with display on the front cover

NOTE – The inverter model should be chosen by a specialized technician who has a good knowledge of the installation conditions, the devices that will be installed externally, and whether it will eventually be integrated into an existing system.

1.1 Main inverter components

Inverter external view			
01	Inverter	10	USB connector for accessories board
02	Heatsink	11	Ethernet 1/2 connectors
03	Synoptic (LED icons)	12	Digital input and RS485 connector
04	Protective earth (PE) external connection point	13	Quick fit input connectors
05	Mounting bracket	14	Wi-Fi antenna connector
07	DC disconnect switch	15	Smart button
08	Signals connection box	16	Anti-condensation valve
09	AC quick fit connector	17	AC output connector
		18	Side bracket screws
		19	Padlock hole
		20	Digital input and RS485 cable gland (M20)
		21	Ethernet 1/2 cable gland (M25)
		23	AC cable gland
		25	Handles (optional)
		26	Display

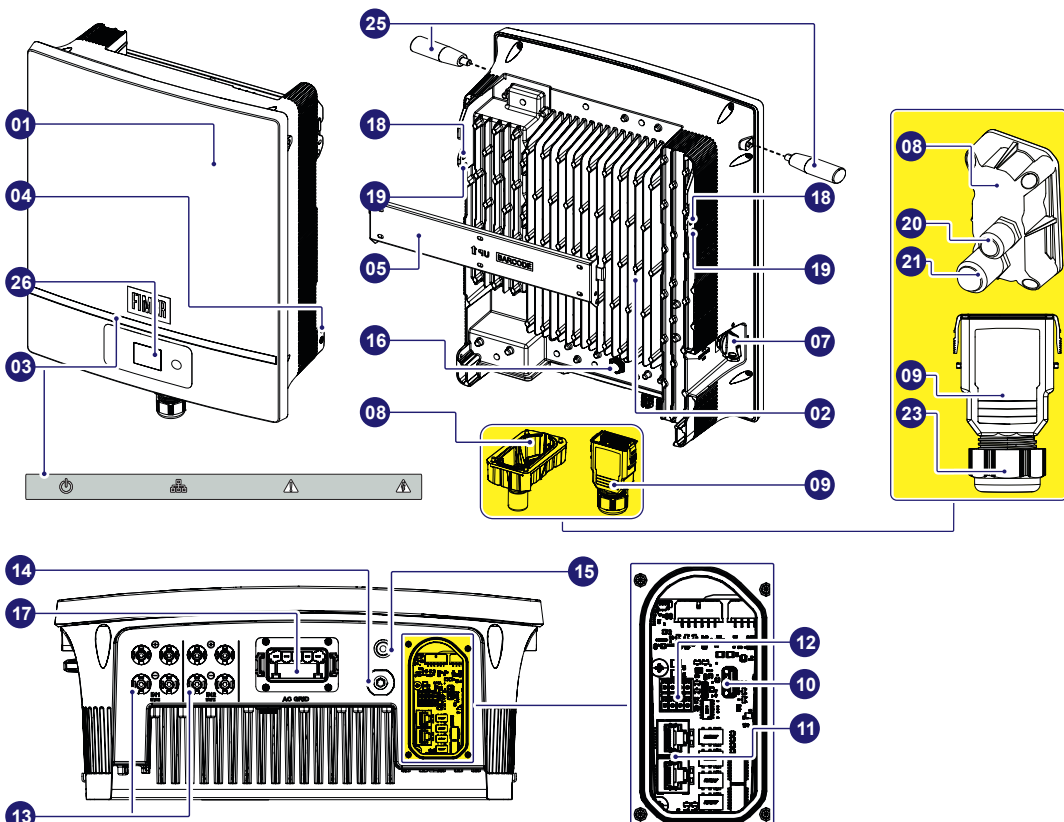

READ THE MANUAL – See the manual for details on the connection of the communication and control signals.

2. Labels and Symbols

The labels on the inverter show the conformity marking, main technical data and identification of the equipment and manufacturer.

NOTE – The below labels are intended as an example only.

Regulatory and identification Label

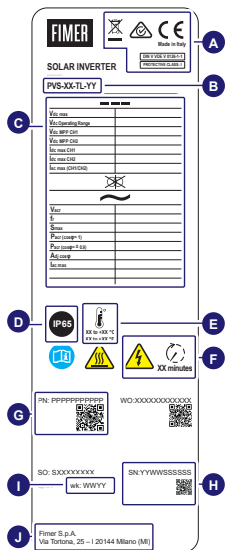

- A Certification marks
- B Inverter model
- C Main technical data
- D IP protection rating
- E Operating temperature range
- F Discharge time
- G Inverter Part Number
Serial Number
 - Inverter access point SSID: FIMER-YYWWSSSSSS
- H • "Host Name": <http://FIMER-YYWWSSSSSS.local>
 - It is required to register the inverter in Aurora Vision.
- I Production date: WWYY where: WW (week) YY (year)
- J Manufacturer
- L WLAN (Wi-Fi) and ETH1/ETH2 (Ethernet) MAC addresses
Product Key. To be used:
 - as wireless access point password
 - to access to the Web UI as username and password in case of lost credentials
 - to commission inverter using FIMER "Installer for Solar Inverters" APP.
- M QR Code:
 - To be used to commission inverter, using FIMER "Installer for Solar Inverters" app, for claiming process.
- N

Communication identification label



- L
- H
- M
- N

ATTENTION – The labels placed on the equipment absolutely **MUST NOT** be removed, damaged, dirtied, hidden, etc.

In the manual and/or in some cases on the equipment, the danger or caution areas are indicated with signs, labels, symbols, icons.

Symbol	Description
	Always refer to instruction manual
	General warning - Important safety information
	Dangerous voltage
	Hot surfaces
	Protection rating of equipment
	Temperature range
	Without insulation transformer
	Direct and alternating current, respectively
	Positive and negative pole of the input voltage (DC)
	Obligation to use protective clothing and/or personal protective equipment
	Point of connection of the protective ground
	Risk of electric shock. The discharge time (quantified in the figure by the number XX) of the stored energy after de-energizing of the Inverter from both DC side and AC side.

3. Lifting and transporting

Transportation and relocation

The transportation of the device, in particular via land transportation, must be made with adequate means and ways to protect the parts from violent impacts, humidity, vibrations, etc.

ATTENTION – If the package is stored correctly, it can withstand a maximum load of 5 stacked pallet (2 units each pallet).

Lifting

The means used for lifting must be able to bear the weight of the equipment.

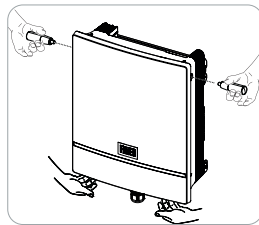

Weight of the equipment

Model	Weight
All models	29.6 Kg / 65lb

Unpacking and inspection

The packaging components must be removed and disposed according to the applicable regulations of the country where the device is installed. Upon opening the packaging, check the integrity of the equipment and verify that all the components are present.

If you notice defects or deterioration, stop the operations and call the carrier, as well as inform FIMER Service immediately.

Please keep the packaging in the event it has to be returned; the use of inadequate packaging will void the warranty.

Always store the Quick Installation Guide, all the supplied accessories in a safe place.

4. Installation planning

General recommendation on installation position

- Refer to Technical data table to check the required environmental conditions (protection rating, temperature, humidity, altitude, etc.).
- The installation location shall be easily accessible.
- Installation of the unit in a location exposed to direct sunlight is NOT acceptable. (Add awning in case of direct sunlight installation).
- Final installation of the device must not compromise access to any disconnection devices that may be located externally.
- Do not install in small closed rooms where air cannot circulate freely.
- Always ensure that the flow of air around the inverter is not blocked so as to prevent overheating.
- Do not install in locations where flammable substances or gases may be present (minimum distance 3 m).
- Do not install on wooden walls or other flammable supports.
- Install on a wall or strong structure suitable to bear the weight.
- Do not install in rooms where people live or where the prolonged presence of people or animals is expected, because of the high noise that the inverter produces during operation. The level of the sound emission is heavily influenced by where the appliance is installed (for example: the type of surface around the inverter, the general properties of the room, etc.) and the quality of the electricity supply.
- All installations over 6561 ft (2,000 meters) must be valued taking in consideration the derating reported in the datasheet.

Tilting admittance

The unit can be installed in vertical with a maximum inclination as indicated in the figures below.

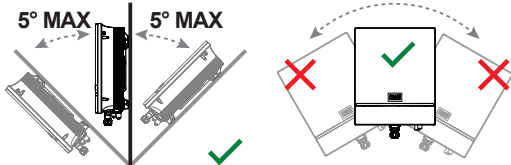

Distances

- Maintenance operations from FIMER service could entails removing the front cover. Always observe the required installation safety distances in order to allow routine check and maintenance operations.
- Provide a sufficient working space in front of the inverter that allows to removing the front cover (FIMER service only) and to allow wiring connections.
- Install at a height which takes into consideration the weight of the unit and in a position which is suitable for servicing, unless suitable means will be provided to carry out these mentioned operations.
- If possible, install at eye-level so to allow to easily check the:
 - synoptic (03).
 - display (26). Only in inverter model with ;DISPLAY suffix.
- Do not install any object (e.g. AC or DC cables) that could be damaged by overheating from outgoing hot air flow coming from top side. In case of this kind of installation needs, please evaluate the installation of a proper air deflector. Always respect the minimum distances required.
- Respect the minimum distances from surrounding objects that could prevent the inverter installation and restrict or block the air flow:

A = 70cm (27")
 B = 50cm (20")
 C = 20cm (8")
 D = 20cm (8")
 E = 50cm (20")

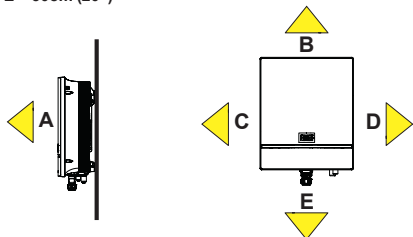

⚠ ATTENTION – Please check the manual for some particular scenarios that may vary the minimum clearance distances.

Installation of multiple units

- In case of installation of multiple units in the same place, position the inverter side by side paying attention to keep the minimum clearance distance G of 30cm/12" (measured from the outer edge of units).

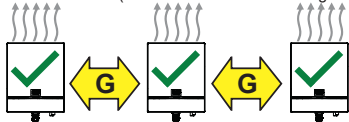

If the space available does not allow this arrangement, position the inverters in a staggered arrangement so that heat dissipation is not affected by other inverters below. Respect the following minimum clearance distances H of 100cm/39" and I of 30cm/12".

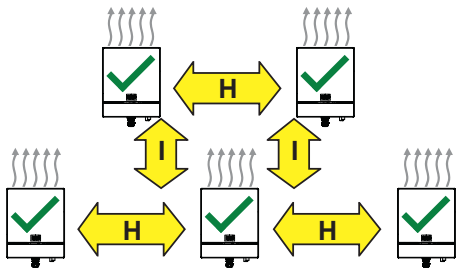









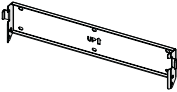
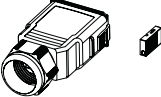

⚠ ATTENTION – Please check the product manual for "Wireless signal environmental checks", "Installations at high altitudes" and "Installations with a high level of humidity".

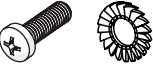
🔧 NOTE – The final installation of the inverter must not compromise the access to any disconnection devices located outside.

🔧 NOTE – Refer to the warranty conditions to evaluate the possible exclusions related to an improper installation.

5. Supplied Component list

Component	Q.ty
 Vertical mounting bracket (05)	1
 AC quick fit connector (09) + locking clip	1 + 1
 Two-hole gasket (6mm Ø) for M20 Digital input and RS485 cable gland (20) and cap	1 + 1
 Three-hole gasket (6mm Ø) for M25 Ethernet 1/2 cable gland (21) and caps	1 + 2
 Three-hole gasket (7mm Ø) for M25 Ethernet 1/2 cable gland (21) and caps	1 + 2
 M6 screw + M6 serrated lock washers to clamp the earth cable on the Protective Earth (PE) external connection point (04)	1 + 2
 Eyelet cable lug (16mm ² wire) for Protective earth (PE) external connection point (04)	1
 Digital input and RS485 counterpart (12)	1
 Wireless antenna (14)	1
 M5 screws (with washers) for mechanically securing the inverter to the bracket (18)	2
 Technical documentation	1

6. Assembly instructions

Bracket installation

The mounting bracket can be used to install the inverter on a vertical support.

- Position the mounting bracket (05) perfectly level on the support and use it as drilling template.

🔧 NOTE – It is the installer's responsibility to choose an appropriate number and distribution of attachment points. The choice must be based on the type of support (wall, frame or other support), the type of anchors to be used, and their ability to support 4 times the inverter's weight (4x29.6Kg/65lbs=118.4Kg/260lbs for all models). Depending on the type of anchor chosen, drill the required holes (4 minimum) to mount the bracket. Put at least 2 screws in the upper side and at least 2 in the lower side.

- Attach the bracket (05) to the support.

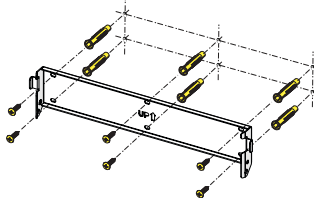

Assembly the Inverter to the bracket

⚠ ATTENTION – It is recommended to use the handles (that have to be ordered separately) to handle and safely install the inverter.

⚠ ATTENTION – Risk of injury due to the heavy weight of the equipment. Always consider the center of gravity of the enclosures while lifting.

- Lift the inverter up to the bracket (05) (using the handles (25) or M8 eyebolts) and insert the two sides anchor points (placed on sides of the wall bracket) into the two slots on the inverter. Check that the anchor points has been correctly inserted in the slots before releasing the inverter.

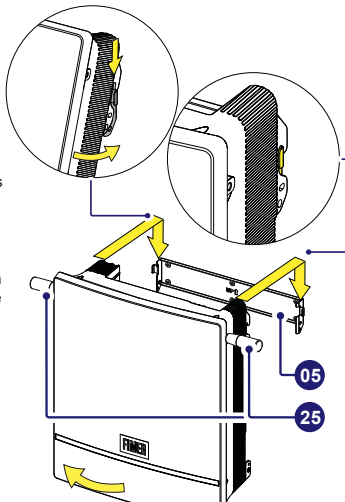

- Remove the handles (25) or eyebolts and tighten the supplied two side bracket screws (18) (Tightening torques 3.5 Nm) to avoid the tilting of the bottom part of the inverter.
- A padlock can be installed to lock the inverter to the bracket so that it cannot be disassembled by outsiders.

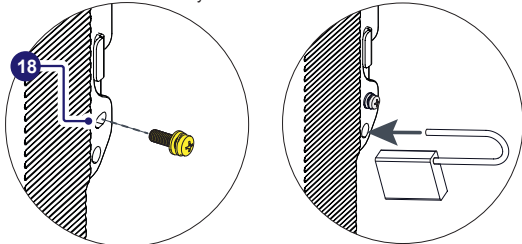

- Remove the protective cover from the connector of the wireless antenna located on the bottom side of the inverter. Install the wireless antenna by screwing it into the specific connector (14).

7. AC grid output connection

7.1 Characteristics and sizing of the protective grounding cable

⚠ ATTENTION – Any failure of the inverter when it is not connected to earth through the appropriate connection point is not covered by the warranty.

The earth connection can be made:

- On the Protective Earth (PE) external connection point (04).

⚠ WARNING – The cross section of the protective earthing conductor must have same cross section as the phases cables and its minimum must be 10 mm² (Copper wire).

- On both Protective Earth (PE) external connection point (04) and on the AC quick fit connector (09) using cables having same cross section as the phases cables.

⚠ ATTENTION – Installation of a second protective earth cable is also required by regulations in force in certain countries of installation.

7.2 Characteristics and sizing of the line cable

The AC cables must be connected to the AC output connector (17) using the specific AC quick fit connector (09) supplied.

AC conductor cable

.....
Cable diameter range	• 11...19 mm or 19...26mm based on the type of seals installed
Conductor cross section	• 6mm ² ...16mm ² (with plastic collar ferrule) accepted by the AC quick fit connector.
Conductor material	copper
.....

7.3 Protection switch under load (AC switch) and differential protection

To protect the AC connection line of the inverter, it is recommended to install a protection device against overcurrent and earth leakages with the following features:

Load protection breaker	PVS-10-TL	PVS-12.5-TL	PVS-15-TL
Type	Automatic circuit breaker with thermal-magnetic protection		
Voltage/current rating	400Vac	400Vac	400Vac
	min25A (*)	min32A (*)	min32A (*)
Magnetic protection	Magnetic curve B/C		
Number of poles	3W (3 phases without neutral wire) or 4W (3 phases with neutral wire).		
Differential protection type	A/AC		
Differential sensitivity	300 mA		

(*): please consider thermal and other derating when selecting the current rating of the protection equipment for your application.

7.4 Connection on the Protective earth (PE) cable

- Strip the cable.
- Install the supplied M6 cable lug on the earth cable.
- Install the earth wire on the Protective earth (PE) external connection point (04) following the installation sequence (Tightening torque 4 Nm):
 - Serrated washer
 - Earth cable
 - Serrated washer
 - M6 screw

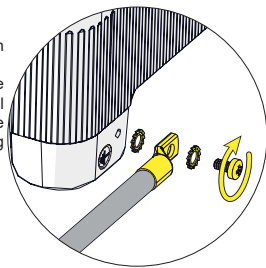

7.5 AC output cables connection

⚠ ATTENTION – Before carrying out any operation, check that any external AC switch downstream to the inverter (grid side) is in OFF position applying LOTO procedure on it.

The connection of the AC cable must be made on the AC output connector (17), located on the bottom side of the inverter, using the AC quick fit connector (09).

- Unscrew the AC cable gland (23) installed on the AC quick fit connector (09).

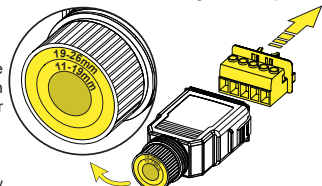

- Remove the internal screw terminal block. Press the 2 retain clips and pull out the screw terminal block.



⚠ ATTENTION – On the connector cable gland 2 gasket are installed that can be used in combination to accept a 11...26mm diameter cable.

- Cable diameter 11...19mm. Default configuration (both gasket installed).
- Cable diameter 19...26mm. Remove the reducing clamping range gasket.

• Pass the AC cable through the AC cable gland (23).

• Strip the AC cable and wires

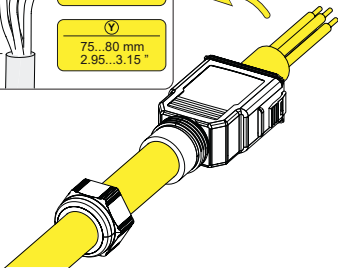
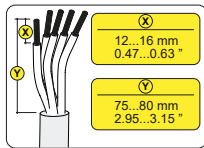

• Install ferrule with plastic collar on the wires.

• Install the wires (based on the AC connection type) respecting the connections as indicated on the screw terminal block (L1=R ; L2=S ; L3=T):

A. Five-cores cable (L1, L2, L3, N and PE).

B. Four-cores cable (L1, L2, L3 and N).

C. Four-cores cable (L1, L2, L3 and PE).

D. Three-cores cable (L1, L2, L3).

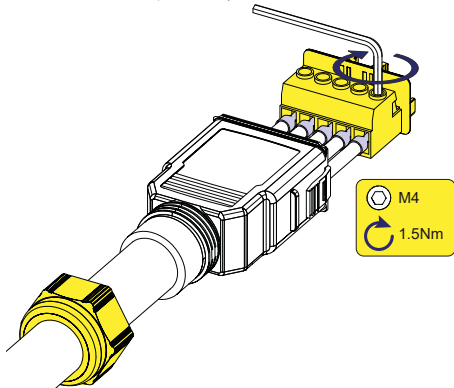

⚠ **ATTENTION** – In case of a wrong phase sequence the inverter will not connect to the grid and it will provide an error state.

• Re-install the screw terminal block inside the AC quick fit connector.

⚠ **ATTENTION** – Push the screw terminal block till a double “click” will be heard.

• Tighten the cable gland ring (7.5Nm).

⚠ **ATTENTION** – Make sure the cable glands are properly sealed to ensure to keep IP65 protection degree.

7.5.1 Connection of AC quick fit connector to the inverter

• Pull out the protective cap from the AC output connector (17).

• Connect the AC quick fit connector (09) to the AC output connector (17).

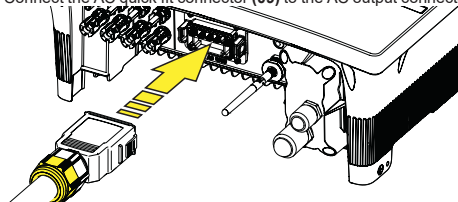

⚠ **ATTENTION** – Push the connector till a double “click” will be heard.

• Secure the AC quick fit connector. Install and screw the holding clip.

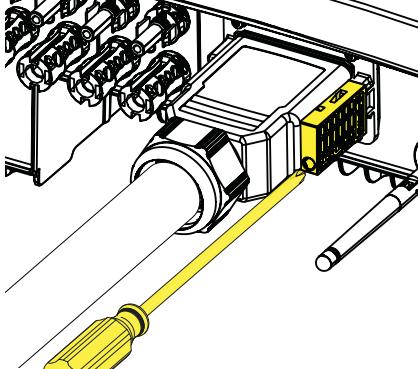

⚠ **ATTENTION** – The AC quick fit connector must not be subject to tensile forces (examples: do not connect weights to the AC cable, do not leave excess cable windings hanging, etc).

8. Input connection (DC)

For the strings connections it is necessary to use the DC quick fit connectors (13), located on the bottom side of the inverter.

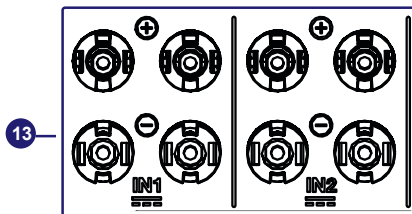

The input connectors are divided into 2 groups (one group for each input MPPT). For each MPPT 2 pairs of quick fit connectors are available. Respect the Maximum DC input power for each MPPT as follow:

MPPT	PVS-10-TL	PVS-12.5-TL	PVS-15-TL
IN1	17A / 7.8kW	18A / 8.3kW	22A / 10kW
IN2	17A / 7.8kW	18A / 8.3kW	22A / 10kW

8.1 Preliminary operations to the connection of the PV generator

- Checking the correct polarity of the strings
- Checking of leakage to ground of the photovoltaic generator
- Checking of strings voltage
- Installation of quick-fit connectors

8.2 Connection of the input strings

⚠ **WARNING** – When the photovoltaic panels are exposed to sunlight they provide continuous DC voltage to the inverter. To avoid risks of electrical shock, all wiring operations must be carried out with the DC disconnect switches (internal (07) and external to the inverter) and external AC disconnect switches OFF.

• Connect all the strings required by the system by pushing the quick fit connectors in the right position.

⚠ **ATTENTION** – Using coupling parts that are not compliant with the quick fit connector models on the inverter could cause serious damage to the unit and lead to invalidation of the warranty.

ATTENTION – Refer to document "String inverters - Product manual appendix" available at www.fimer.com to find out the manufacturer and model of quick fit connector used on the inverter.

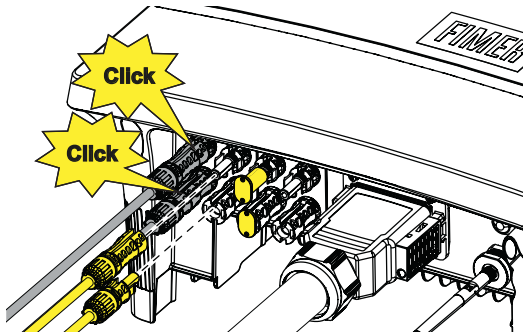

ATTENTION – Check that protective caps are installed on unused connectors. This is necessary for the inverter seal and to avoid any damage to the unused connectors which may be used at a later time.

ATTENTION – The quick fit connectors must be properly installed. After the installation make sure the connectors are correctly locked through the clips.

• Scan the QR code on the Communication identification label and connect to inverter network.

NOTE – The name of the Wi-Fi network created by the inverter will be: FIMER-YYWSSSSSS (10 digit Inverter SN).

NOTE – After this step wait 10 seconds to allow the Wi-Fi connection. Once connected, the commissioning wizard will start.

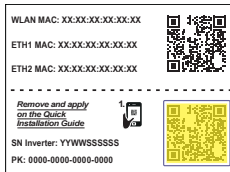

9. Instruments

The synoptic (03) allows to view inverter status conditions to be analyzed in greater depth by consulting the manual.

	POWER Solid when the inverter is working correctly. Flashes when checking the grid or if there is insufficient sunlight.
	WLAN Indicates the status of the Wi-Fi or Ethernet communication lines.
	ALARM The inverter has detected an anomaly. The anomaly is shown on the "EVENTS" section of the internal webserver.
	GFI Ground fault on the DC side of the PV generator. The error is shown on the "EVENTS" section of the internal webserver.

NOTE – The icons, in various combinations, can indicate multiple conditions other than the original single condition; see the various descriptions on the product manual.

10. Commissioning

The inverter can be commissioned in a simple and intuitive way through the Installer for solar inverters APP for mobile devices.

NOTE – The same configurations can be done via internal web User Interface (see product manual).

• Supply the inverter with DC input voltage from the photovoltaic generator and via AC grid voltage.

ATTENTION – The inverter configuration can be also performed with only one supply source (DC or AC).

ATTENTION – With DC supply, make sure that the irradiation is stable and adequate for the inverter commissioning procedure to be completed.

• Open the " Installer for solar inverters" APP.

• Login or Sign-In to Aurora vision account.

• Tap on "Commissioning wizard". A QR code scanner will be opened.

10.1 COMMISSIONING WIZARD

10.1.1 Network configuration.

• Choose the connection type (ethernet or wireless) and set the related parameters.

NOTE – This step can be skipped and performed later (via WebUI).

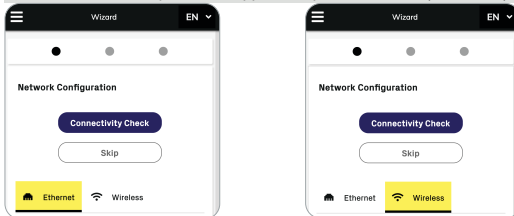

• Once network parameters were setted, tap on "Next".

10.1.2 Date and Time.

• Set the Date, Time and Time zone (The inverter will propose these fields if connected to internet).

• Once date and time were setted, tap on "Next".

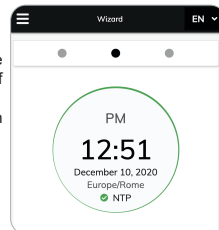

10.1.3 Inverter configuration.

Country standard

• Set the grid standard of the country in which the inverter is installed. Some Country standards have different grid voltage that should be setted during this step.

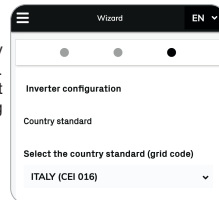

• Confirm the settings by clicking "Save". The configuration wizard is complete and the inverter will reboot.

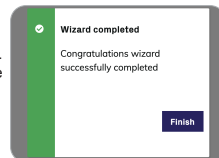

• If the outcome of the preliminary checks on the grid parallel is positive, the inverter connects to the grid and starts to export power to the grid. The "Power" LED remains fixed on while the "Alarm" and "GFI" LEDs are off.

NOTE – To address any problems that may occur during the initial stages of operation of the system and to ensure the inverter remains fully functional, you are advised to check for any firmware updates in the download area of the website www.fimer.com or at <https://registration.solar.fimer.com> (instructions for registering on the website and updating the firmware are given in the product manual).

11. Features and Technical Data

	PVS-10-TL	PVS-12.5-TL	PVS-15-TL
Input side			
Absolute maximum DC input voltage (Vmax,abs)		1100 V	
Start-up DC input voltage (Vstart)		250...500V (default 360V)	
Operating DC input voltage range (Vdcmín...Vdcmax)		200...1000 V	
Rated DC input voltage (Vdcr)		620V	
Rated DC input power (Pdcr)	10200 W	12760 W	15300 W
Number of independent MPPT		2	
Recommended maximum PV array power (PPV, max)	14500 Wp	18125 Wp	21750 Wp
Maximum DC input power for each MPPT (PMPPT,max)	7800W	8300W	10000W
MPPT DC voltage range (VMPP,Tmin... VMPP,Tmax) at Pacr		460-850V	
Maximum DC input current (Idcmax) for each MPPT	17A	18A	22A
Maximum input short circuit current for each MPPT		30 A	
Maximum return current (AC side vs DC side)		Negligible in normal operating conditions ⁽⁶⁾	
Number of DC inputs pairs for each MPPT		2	
DC connection type		PV quick fit connector ⁽⁶⁾	
Type of PV panels that can be connected according to IEC 61730		Class A	
Input protection			
Reverse polarity protection		Yes, from current limited source	
Input over voltage protection for each MPPT		SPD Type 2 / Type 1+2 (optional)	
Photovoltaic array isolation control		Yes, according to IEC 62109-2 or according to local regulation	
Residual current monitoring Unit (leakage current protection)		Yes, according to IEC 62109-2	
DC switch rating for each MPPT (version with DC switch)		Rating DC-PV1: 50A@600Vdc, 40A@800Vdc, 30A@1000Vdc	
String Fuse		Fuseless	
Input current monitoring		String level	
Output side			
AC Grid connection type		Three phase (3W+PE or 4W+PE)	
Earthing system		TN-S, TN-C, TN-CS, TT	
Rated AC power (Pacr @cosφ=1)	10000 W	12500 W	15000 W
Maximum AC output power (Pacmax @cosφ=1)	10000 W	12500 W	15000 W
Maximum apparent power (Smax)	10000 VA	12500 VA	15000 VA
Maximum reactive power (Qmax)	6000 VAR	7500 VAR	9000 VAR
Nominal power factor and adjustable range		> 0,995; 0...1 inductive / capacitive	
Rated AC grid voltage (Vac,r)		380V, 400V ⁽⁵⁾	
Maximum AC output current (Iac,max)	16 A	20 A	23 A
Contributory fault current		Iac,max x 1,15	
Rated output frequency (fr)		50 Hz / 60 Hz	
Output frequency range (fmin...fmax)		47...63 Hz / 57...63 Hz ⁽⁶⁾	
Max DC Current Injection (% of Iac,max)		< 0.5% Iac,max	
Maximum AC cable		16 mm ² copper	
AC connection type		AC quick fit connector	
Output protection			
Anti-islanding Protection		According to local standard	
Maximum external AC overcurrent protection	25 A	32 A	32 A
Output overvoltage protection		SPD Type 2	
Operating performance			
Maximum Efficiency (ηmax)	98.4%	98.5%	98.5%
Weighted Efficiency (EURO)	98.1%	98.2%	98.2%
Environmental			
Operating ambient temperature range		-25...+60°C (-13...140 °F) with derating above 45 °C (113 °F)	
Storage temperature		-40°C...+85°C / -40°F...185°F	
Relative Humidity		4...100 % with condensation	
Sound pressure level, typical	40 dB(A) @ 1m	45 dB(A) @ 1m	45 dB(A) @ 1m
Maximum operating altitude		4000 m (13123 ft) with output power [Pout] linear derating above 2000m (6561 ft) ⁽⁶⁾	
Environmental pollution degree classification for external environments		3	
Environmental class		Outdoor	
Physical			
Inverter typology		Grid connected, Double stage, Transformerless	
Environmental Protection Rating		IP65	
Cooling System		Natural	
Dimension (H x W x D)		H = 568.2 mm / 22.37" (644mm / 25.35" with AC quick fit connector) ; W = 473.6 mm / 18.64" ; D = 207 mm / 8.15"	
Weight		29.6 Kg / 65lb	
Overvoltage rating as per IEC 62109-1		II (DC input) III (AC output)	
Safety			
Safety class		I	
Insulation Level		Transformerless	
Marking		CE ⁽⁶⁾ , RCM	

- The AC voltage range may vary depending on specific country grid standards.
- The Frequency range may vary depending on specific country grid standards.
- Please refer to the document "String Inverters – Product manual appendix" available at www.fimer.com for information on the quick-fit connector brand and model used in the inverter.
- Hereby, FIMER S.p.A. declares that the radio equipments (radio module combined with

- the inverter) are in compliance with the Directive 2014/53/EU. The full text of the EU Declaration of Conformity is available at the following internet address: www.fimer.com
- @ 4000m (45 °C ambient temperature), the output power (Pout) is reduced by 15%.
 - In the event of a fault, limited by the external protection envisaged on the AC circuit.

Features not specifically mentioned in this data sheet are not included in the product.



FIMER_PVS-10_12.5_15-TL_Quick Installation Guide_EN_RevA

22-03-2021

For more information please contact your local FIMER representative or visit:

fimer.com

We reserve the right to make technical changes or modify the contents of this document without prior notice. With regard to purchase orders, the agreed particulars shall prevail. FIMER does not accept any responsibility whatsoever for potential errors or possible lack of information in this document.

We reserve all rights in this document and in the subject matter and illustrations contained therein. Any reproduction, disclosure to third parties or utilization of its contents – in whole or in parts – is forbidden without prior written consent of FIMER. Copyright© 2021 FIMER. All rights reserved.