

FIMER



Solar Inverter

REACT2

Quick Installation Guide

In addition to what is explained in this quick installation guide, the safety and installation information provided in the product manual must be read and followed. The technical documentation for the product is available at the website. The device must be used in the manner described in the manual. If this is not the case the safety devices guaranteed by the inverter might be ineffective.

⚠ ATTENTION – IMPORTANT SAFETY INSTRUCTIONS

This document contains important safety instructions that must be followed during the installation and maintenance of the equipment.

⚠ ATTENTION – SAVE THESE INSTRUCTIONS

Keep this document in a safe place near the inverter for easy access during installation, operation and maintenance.

⚠ ATTENTION – The installer must read this document in its entirety before installing or commissioning this equipment. In addition to what is explained below, the safety and installation information provided in the product manual must be read and followed. For more detailed information regarding proper installation and use of this product, refer to the product manual located at www.fimer.com.

⚠ ATTENTION – The product must be used in the manner described in the document. If this is not the case the safety devices guaranteed by the inverter might be ineffective.

⚠ ATTENTION – All pictures and illustrations shown in this document are indicative and must be intended as support for installation instruction only. Actual product may vary due to product enhancement. Specifications subject to change without notice. The latest version of this document is available on the FIMER website.

Table of Content

1. Reference number index	4
2. Labels and Symbols	7
3. Lifting and transport	8
4. List of supplied components	9
5. Choice of installation location	10
6. Mounting Instructions.	11
7. Mounting Instruction - multi battery systems	13
8. Connection of the energy meter	15
9. Line cable and protection devices	19
10. Output connection (AC)	20
11. Backup cable and protection devices	21
12. Backup output connection (AC)	21
13. Input configuration (DC)	22
14. Input connection (DC)	23
15. Connection of the communication and control signals	24
16. Description of the synoptic	26
17. Commissioning	28
18. Characteristics and technical data	32

1. Reference number index

Inverter external view

01	REACT2-UNO wall bracket	31	Coin cell
02	REACT2-UNO	32	DC input terminal
03	Synoptic	33	Memory card
04	Heat sink	34	RS485-METER communication card
05	REACT2-UNO front cover	35	RS485-PC communication card
06	Input connectors MPPT1 (IN1)	36	RS485-LOGGER communication card
07	DC and battery disconnect switch	37	RS485-LOGGER line termination switch
08	Battery communication connector COMM.[A]	38	RS485-PC line termination switch
09	Battery power connector POWER [A]	39	RS485-METER line termination switch
10	REACT2-UNO wall attachment point	40	Communication and control signal screw terminal block
11	REACT2-UNO external protective earth	41	Multifunctional relay screw terminal block
12	Input connectors MPPT2 (IN2)	42	AC output (BACKUP) screw terminal block
13	Service cable gland	43	AC output (GRID) screw terminal block
14	METER connector	44	Cable conduit
15	Wi-Fi antenna connector	50	Meter ABB B21
16	AC output (BACKUP) cable gland	51	Hole for line cable
17	AC output (GRID) connector	52	Hole for line cable
20	REACT2-BATT wall bracket	53	AC power supply terminal block
21	REACT2-BATT	54	METER RS485 screw terminal block
22	Battery communication connector COMM.[B]	55	METER ABB B23, B24
23	Battery power connector POWER [B]	56	Inverter and loads side screw terminal block (B23,B24 meter)
24	REACT2-BATT external protective earth [B]	57	METER RS485 screw terminal block
25	REACT2-BATT external protective earth [A]	58	Grid side screw terminal block (B23,B24 meter)
26	REACT2-BATT wall attachment point	59	Grid side screw terminal block (B21 meter)
30	LAN Ethernet connector (RJ45)	60	Inverter and loads side screw terminal block (B21 meter)

1.1 REACT2-UNO-3.6/5.0-TL (external view)

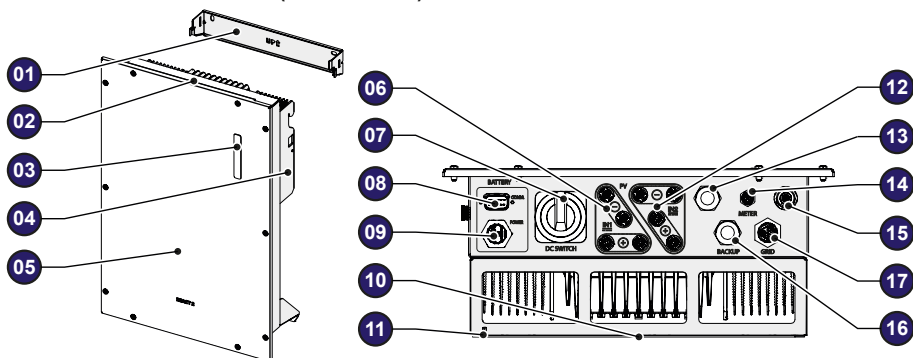

1.2 REACT2-BATT (external view)

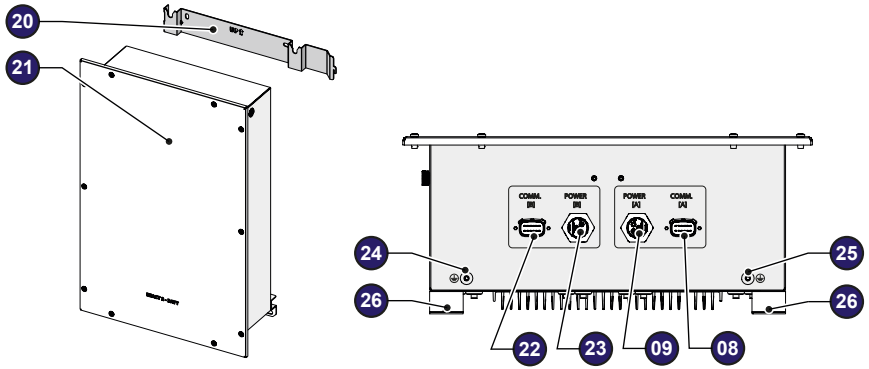

1.3 REACT2-UNO-3.6/5.0-TL (internal view)

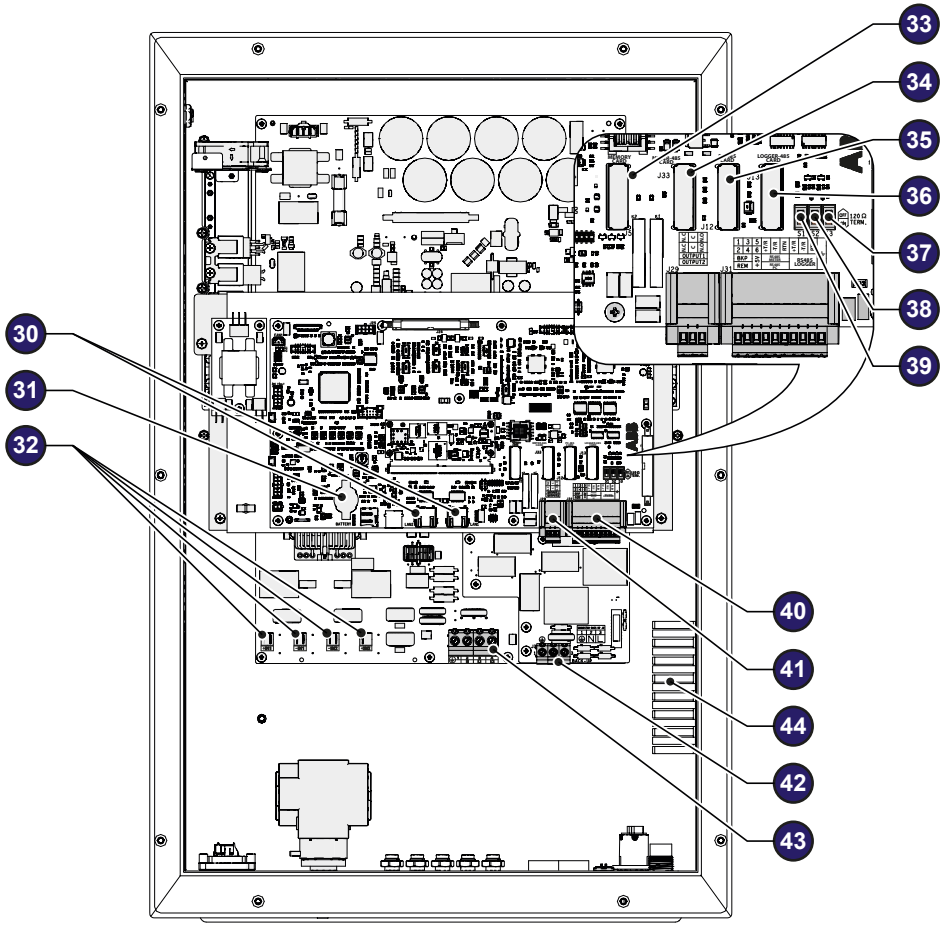

1.4 REACT-MTR-1PH

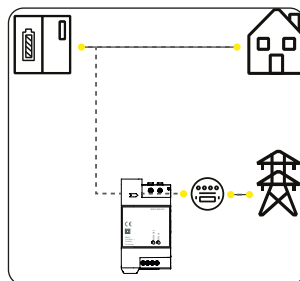
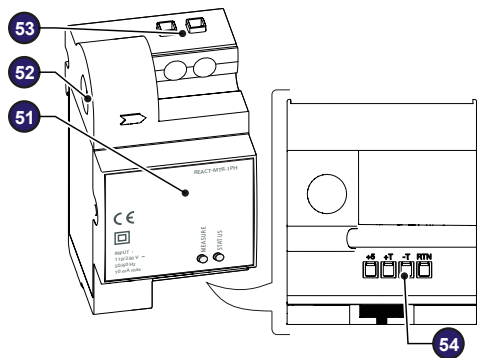

1.5 Meter ABB B21

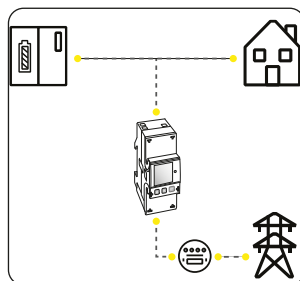
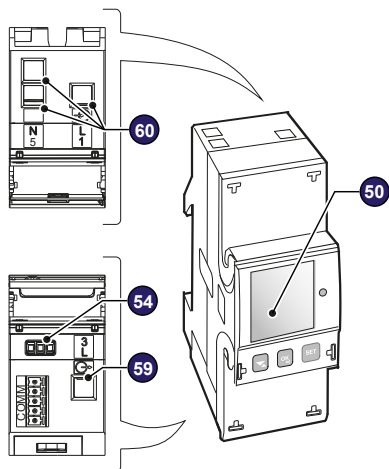

1.6 Meter ABB B23, B24

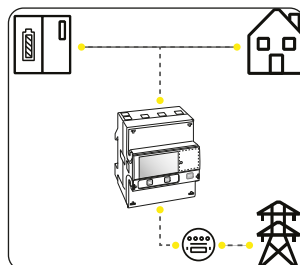
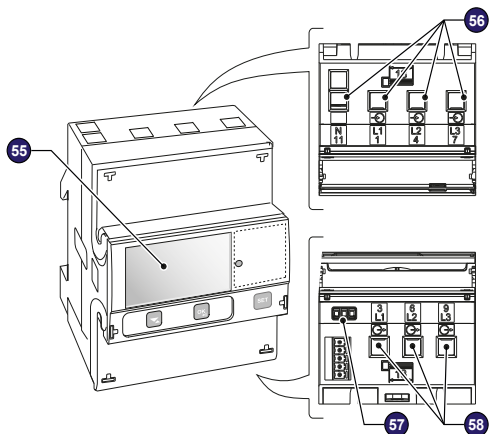

2. Labels and Symbols

The labels on the inverter and on battery unit have the Agency marking, main technical data and identification of the equipment and manufacturer.

EN 50575 VDE 0113
 PROTECTIVE CLASS 3
 (AVAIL. CONDITION)

SOLAR INVERTER A MODEL: **REACT2-UINO-3.6-TL**

Vdc max	575 V	Vacr	230 V 10
Vdc operating range	30 - 575 V	f	50 Hz
Vdc min	160 - 480 V	P _{rated} (cont. 2.5h)	3600 W
I _{dc} max	2 x 12 A	P _{ac} (cont. 1h)	3600 W
I _{dc} max	2 x 15 A	S _{max}	3600 VA
		A _{ul} (cont.)	0.1 - 1"
		I _{ac} max	16 A

(1): Overload not suited

BATTERY PORT

Vdc Operating Range	170 - 575 V
I _{dc} max (charge)	13.5 A
I _{dc} max (discharge)	10 A

BACKUP OUTPUT

Vacr	230 V 10
f	50 Hz
I _{ac} max	13 A
S _{ac}	3000 VA

PROTECTIVE EARTHING REQUIRED

-20 to +55 °C
 -4 to +131 °F

PN: PPPPPPPPPPPPP
B

WO:XXXXXXXXXXXXX

SO: XXXXXXXX
 QXX

SN:YYWWSSSSSS
C
D

Fimer S.p.A.
Via Tortona, 25 - I 20144 Milano (MI)

EN 50575 VDE 0113
 PROTECTIVE CLASS 3
 (AVAIL. CONDITION)

SOLAR INVERTER A MODEL: **REACT2-UINO-5.0-TL**

Vdc max	575 V	Vacr	230 V 10
Vdc operating range	30 - 575 V	f	50 Hz
Vdc min	160 - 480 V	P _{rated} (cont. 2.5h)	5000 W
I _{dc} max	2 x 13.5 A	P _{ac} (cont. 1h)	4500 W
I _{dc} max	2 x 15 A	S _{max}	5000 VA
		A _{ul} (cont.)	0.1 - 1"
		I _{ac} max	22 A

(1): Overload not suited

BATTERY PORT

Vdc Operating Range	170 - 575 V
I _{dc} max (charge)	13.5 A
I _{dc} max (discharge)	10 A

BACKUP OUTPUT

Vacr	230 V 10
f	50 Hz
I _{ac} max	13 A
S _{ac}	3000 VA

PROTECTIVE EARTHING REQUIRED

-20 to +55 °C
 -4 to +131 °F

PN: PPPPPPPPPPPPP
B

WO:XXXXXXXXXXXXX

SO: XXXXXXXX
 QXX

SN:YYWWSSSSSS
C
D

Fimer S.p.A.
Via Tortona, 25 - I 20144 Milano (MI)

EN 50575 VDE 0113
 PROTECTIVE CLASS 3
 (AVAIL. CONDITION)

BATTERY UNIT A MODEL: **REACT2-BATT**

Vdc max	575 V
Vdc operating range	170 - 575 V
I _{dc} max (charge)	4.5 A
I _{dc} max (discharge)	5.6 A
Whr	4.0 kWh

-20 to +55 °C (F)
 -4 to +131 °F (F)

(*) Out of 0 to +40 °C (+32 to +104 °F) temperature range, power derating occurs

WARNING!

- Refer to instruction manual for proper installation.
- Do not remove the cover: No user serviceable parts inside.
- Do not expose the unit to heating sources.
- Do not expose the unit to direct solar irradiation.
- Do not install or operate the unit in potentially explosive atmospheres.

PN: PPPPPPPPPPPPP
B

WO:XXXXXXXXXXXXX

SO: XXXXXXXX
 QXX

SN:YYWWSSSSSS
C
D

Fimer S.p.A.
Via Tortona, 25 - I 20144 Milano (MI)

- A. Inverter/battery model
- B. Inverter/battery Part Number
- C. Inverter/battery Serial Number
- D. Week/Year of manufacture
- E. Main technical data

SN WLAN: SSSSSSSSSS

F

PN WLAN: PPP.PPPPP.PP

G

MAC: XX:XX:XX:XX:XX:XX

H

SN Inverter: SSSSSSSSSS
4.B.B.C. XXXXXXXXXX

J

PK: KKKK-KKKK-KKKK-KKKK

I

Remove and apply on the Quick installation guide

- F. WLAN embedded board Serial Number
- G. WLAN embedded board Part Number
- H. MAC address:
 - To be used to obtain the SSID of the wireless access point created by the inverter: ABB-XX-XX-XX-XX-XX-XX (where "X" is a hex digit of the MAC address).
 - To be used to obtain the "Host Name": http://ABB-XX-XX-XX-XX-XX-XX.local (where "X" is a hex digit of the MAC address).
- I. Product Key:
 - To be used as wireless access point password, or to be used to access to the Web UI as username and password in case of lost credentials, and to commission inverter using FIMER Installer for Solar Inverters.
- J. QR Code:
 - To be used to commission inverter using FIMER Installer for Solar Inverters for claiming process.

⚠ ATTENTION – The labels attached to the equipment must NOT be removed, damaged, dirtied, hidden, etc...

⚠ ATTENTION – If the Admin Plus password is requested, the field to be used is the serial number -SN: YYWWSSSSSS-.

In the manual and/or in some cases on the equipment, the danger or hazard zones are indicated with signs, labels, symbols or icons.



Always refer to instruction manual



ATTENTION- Important safety information



WARNING - Hazardous voltage



Hot surfaces



Risk of electric shock. The discharge time (quantified in the figure by the number XX) of the stored energy after de-energizing of the Inverter from both DC side and AC side.



Positive pole and negative pole of the input voltage (DC)



Direct and alternating currents, respectively



Temperature range



Always use safety clothing and/or personal safety devices



Without isolation transformer



Point of connection for grounding protection



Protection rating of equipment

🔧 NOTE – The choice of the inverter model must be made by a qualified technician who knows about the installation conditions, the devices that will be installed outside the inverter and possible integration with an existing system.

3. Lifting and transport

Transport and handling

Transportation of the equipment, especially by road, must be carried out using appropriate vehicles and methods to protect the components (particularly electronic components) from violent shocks, humidity, vibration, etc.

Note for REACT2-BATT: the road transport is regulated by the ADR international agreement.

Lifting

FIMER usually stores and protects individual components by suitable means to make their transport and subsequent handling easier. Nonetheless, as a rule, it is necessary to turn to the experience of specialised staff to take charge of loading and unloading components.

Where indicated and/or available, eyebolts or handles, which can be used as anchorage points, are inserted and/or can be inserted.

The means used for lifting must be suitable to bear the weight of the equipment.

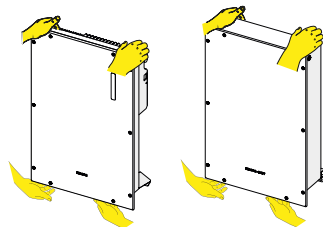

Equipment weight

Device	Weight (kg)	Lifting points
REACT2-UNO-3.6/5.0-TL	< 22 kg	4 (suggested in case of 2 operators)
REACT2-BATT	50 kg	4 (suggested in case of 2 operators)

















🔧 LIFTING – The number of required operators necessary to lift the equipment must be in accordance to local regulations relating lifting limits per operator

Unpacking and checking

The components of the packaging must be disposed on in accordance with the regulations in force in the country of installation.

When you open the package, check that the equipment is undamaged and make sure all the components are present. If you find any defects or damage, stop unpacking and consult the carrier, and also promptly inform the Service FIMER.

4. List of supplied components

Available components for REACT2-UNO		Qty
	Bracket for REACT2-UNO wall mounting	1
	Connector for connection of the multifunctionale relay	2
	Connector for connecting the communication and control signals	1
	M5 hex nuts , M5 flat washer and M5 serrated lock washers for protective earth cable installation	1+1+1
	Jumpers for configuration of the parallel input channels	1 (red) + 1 (black)
	EMI filter for AC output (BACKUP) cable gland (16)	1
	Wi-Fi antenna	1
	AC output (GRID) connector (17) counterpart	1
	METER connector (14) counterpart	1
	Technical documentation	1
Available components for REACT2-BATT		Qty
	Bracket for REACT2-BATT wall mounting	1
	REACT2-BATT power connection cable	1
	REACT2-BATT signal connection cable	1
	Cable lug for earth cable	2
	M5 hex nuts , M5 flat washer and M5 serrated lock washers for protective earth cable installation	1+1+1
	Technical documentation	1

5. Choice of installation location

5.1 General recommendation on installation position

- See characteristics and technical data paragraph to check the required environmental conditions (protection rating, temperature, humidity, altitude, etc.)
- The installation location shall be easily accessible
- The inverter operates normally up to 2000 meters; Above 2000 meters the inverter works in derating.
- Never open the REACT2-UNO in the case of rain, snow or a level of humidity >95%.
- Prevent access to the installation location by children
- Installation of the unit in a location exposed to solar rays makes the warranty void as it may cause:
 - power limitation phenomena in the inverter and in the battery unit
 - premature wear of the electrical/electromechanical components
 - premature wear of the mechanical components (gaskets) and of the user interface (synoptic)
 - reduction in performance, lifetime and possible damage of the battery unit
- Do not install in small closed rooms where air cannot circulate freely
- Always ensure that the flow of air around the inverter is not blocked so as to prevent overheating.
- Do not install in locations where flammable substances or gases may be present
- Do not install on wooden walls or near flammable substances.
- Do not install in locations with a constant presence of water and/or high humidity level.
- Respect the minimum distances from objects around the REACT2-UNO and REACT2-BATT that could prevent the inverter installation and restrict or block the air flow.
- The installation must take account of any electrical devices (e.g. lamps, switches, etc.) which must be at least 20cm from the equipment. These distances must be maintained also to facilitate the circulation of the air needed to cool the unit and to facilitate the operations to install/maintain hardware and software which is done by dismantling the covers placed on the front.
- Install vertically with a maximum inclination of 5° (forward or backward).
- For a multiple installation, position the inverters side by side. If the space available does not allow this arrangement, position the inverters in a staggered arrangement (as shown in the figure) so that heat dissipation is not affected by other inverters:
 - Two or more REACT2-BATT can be installed one above the other.
 - Do not install the REACT2-BATT above the REACT2-UNO.
- The REACT2-UNO and REACT2-BATT can be installed separately and at greater distances
- using the "REACT2-XL-CABLE-KIT" cable kit (2 meter cables length).

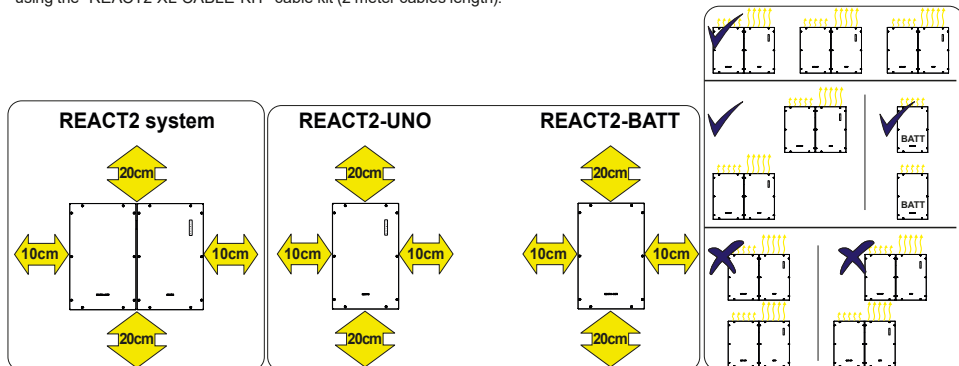

- Do not install in rooms where people live or where the prolonged presence of people or animals is expected, because of the noise that the system produces during operation. The level of the sound emission is heavily influenced by where the appliance is installed (for example: the type of surface around the inverter, the general properties of the room, etc.) and the quality of the electricity supply
- Avoid electromagnetic interference that can compromise the correct operation of electronic equipment, with the consequent hazards
- The ambient temperature of the installation location should be between 5°C and 30°C to guarantee the optimal operation of the battery unit (REACT2-BATT). Here below are the functions available from the system on the basis of the ambient temperature:

T1	T2	T3
- Optimal operation of the REACT2 system	- Correct operation of the REACT2 system with possible reduction of power	- Operation limited to the inverter part only. Management of the battery is disabled.

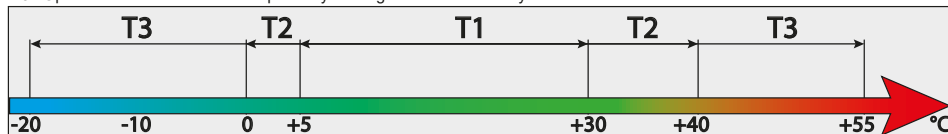

- Hardware and software maintenance on REACT2-UNO entails opening the front cover. Check that the correct installation safety distances are observed in order to allow routine check and maintenance operations.
- Install on a wall or strong structure suitable to bear the weight.
- Install at a height which takes into consideration the weight of the appliance and in a position which is suitable for servicing, unless suitable means are provided to carry out the operation.

- If possible, install at eye-level so that the synoptic can be seen easily.
- The inverter can be commissioned and monitored using the wireless communication channel. The WLAN uses radio waves to transmit and receive data, it is therefore important to find a position for the router considering the different materials which the radio signal will have to pass through:

Material	Relative signal reduction
Open field	0% (strength of approximately 40 meters)
Wood / Glass	From 0 to 10%
Stone / Plywood	From 10 to 40%
Reinforced concrete	From 60 to 90%
Metal	Up to 100 %

⚠ ATTENTION – Final installation of the inverter must not compromise access to any externally located disconnection devices.

6. Mounting Instructions

Wall installation of the REACT2 system

- Position the REACT2-UNO bracket (01) so that it is perfectly level on the wall and use it as a drilling template.
- It is the installer's responsibility to choose an appropriate type of screw anchors for the attachment points. The choice must be based on the type of support (wall, frame or other support), the type of anchors to be used, and their ability to support 4 times the inverter's weight (4x22Kg=88Kg). Depending on the type of anchor chosen, drill the required 2 holes (A) to mount the bracket.
- Install the REACT2-UNO bracket (01) to the support.

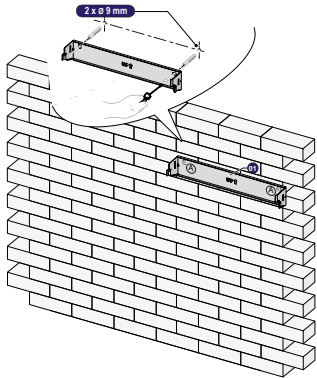

📖 READ THE MANUAL – The underlying procedure is related to the side-by-side installation of REACT2-BATT. Alternatively, is possible to install the REACT2-BATT separately and at greater distances using the "REACT2-XL-CABLE-KIT" cable kit (2 meter cables length).

- Position the REACT2-BATT bracket (20) so that it is perfectly level on the wall and use it as a drilling template. To align the two brackets use the reference point and follow the steps as in the picture.
- It is the installer's responsibility to choose an appropriate type of screw anchors for the attachment points. The choice must be based on the type of support (wall, frame or other support), the type of anchors to be used, and their ability to support 4 times the inverter's weight (4x50Kg=200Kg)
- Depending on the type of anchor chosen, drill the required 2 holes (B) to mount the bracket.
- Install the REACT2-BATT bracket (20) to the support.

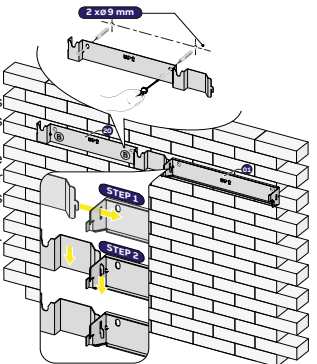

- Lift the REACT2-BATT up to the bracket and insert the heads of two anchor points (present on the back of the battery unit) into the slots **(20)** on the bracket.

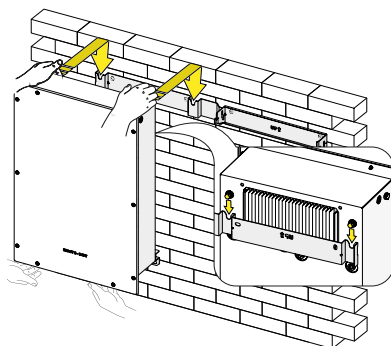

LIFTING – Risk of injury due to the heavy weight of the equipment

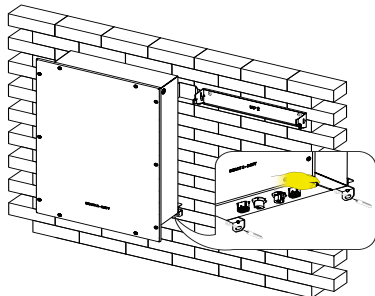

- Hang up the lower part of the REACT2-BATT to the wall using the two wall attachment point **(26)** (holes diameter 11 mm).

- Carefully lift the REACT2-UNO and hook it to the bracket **(01)** by inserting the two supports in the slots on the inverter.

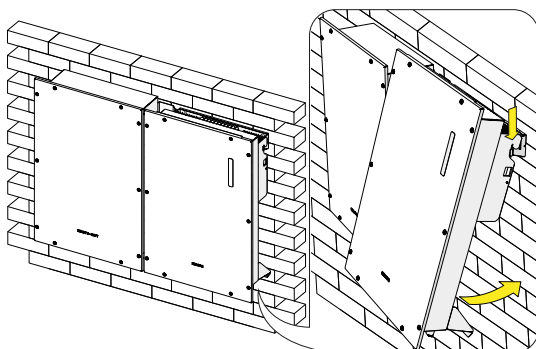

LIFTING – Risk of injury due to the heavy weight of the equipment.

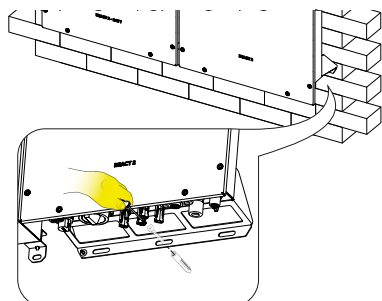

- Hang up the lower part of the REACT2-UNO to the wall using the one anchor point (hole diameter 11mm).

- Remove the caps from the battery and inverter connectors.
 - To remove the battery signal connectors **(08)** simply pull it.
 - To remove the battery power connectors **(09)** press the latch (highlighted in red) and pull it off.

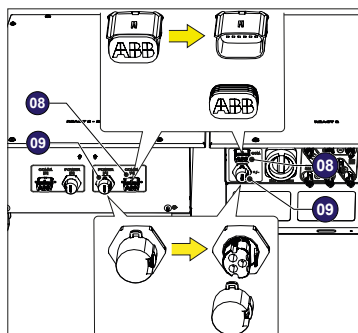

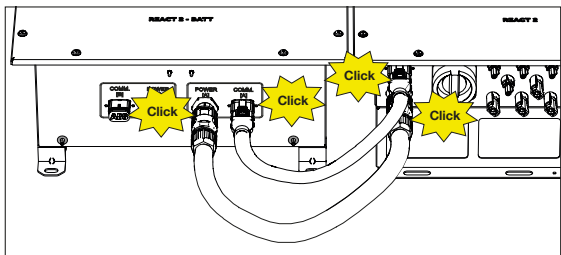

⚠ ATTENTION – To avoid risks of electrical shock and battery damage (notified by E097 error), all wiring operations must be carried out with AC disconnected and DC switch in OFF position. Faulty units are considered out of warranty.

- Connect the two battery cables between inverter and battery unit (supplied inside the REACT2-BATT box).
- Give each cable a pull test to confirm the connection is secure.

- Remove the protective cover from the connector of the Wi-Fi antenna (22) located on the lower part of the REACT2-UNO (02) and install the Wi-Fi antenna (supplied inside the REACT2-UNO box) by screwing it into the specific connector.

- Make the electric connections using personal protective clothing and/or equipment, such as insulating gloves.

- Proceed with installation of the energy meter.

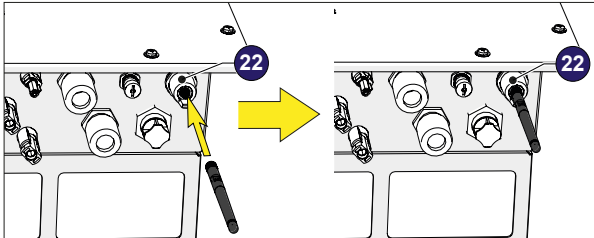

7. Mounting Instruction - multi battery systems

📖 READ THE MANUAL – The underlying procedure is related to the side-by-side installation of REACT2-BATT. Alternatively, it is possible to install the REACT2-BATT separately and at greater distances using the “REACT2-XL-CABLE-KIT” cable kit (2 meter cables length).

- Position the REACT2-BATT bracket (20) of the second REACT2-BATT so that it is perfectly level on the wall and use it as a drilling template. To align the brackets of the two REACT2-BATT (in case of side-by-side installation) use the reference point and follow the steps as in the picture.
- It is the installer’s responsibility to choose an appropriate type of screw anchors for the attachment points. The choice must be based on the type of support (wall, frame or other support), the type of anchors to be used, and their ability to support 4 times the inverter’s weight (4x50Kg=200Kg). Depending on the type of anchor chosen, drill the required 2 holes **B** to mount the bracket.
- Depending on the type of anchor chosen, drill the required 2 holes **B** to mount the bracket.
- Fix the REACT2-BATT bracket (20) to the support.
- Lift the REACT2-BATT up to the bracket and insert the heads of two anchor points (present on the back of the battery unit) into the slots **U** on the bracket (20).

🚚 LIFTING – Risk of injury due to the heavy weight of the equipment.

- Hang up the lower part of the REACT2-BATT to the wall using the two wall attachment point (26) (holes diameter 11 mm).

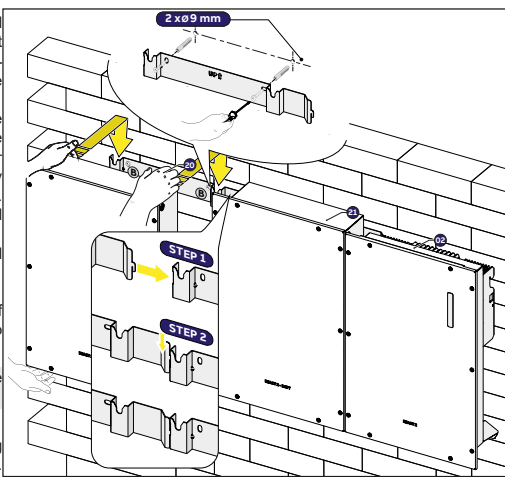

- Remove the caps from the battery units connectors.
 - To remove the battery signal connectors (08) (22) simply pull it.
 - To remove the battery power connectors (09) (23) press the latch (highlighted in red) and pull it off.

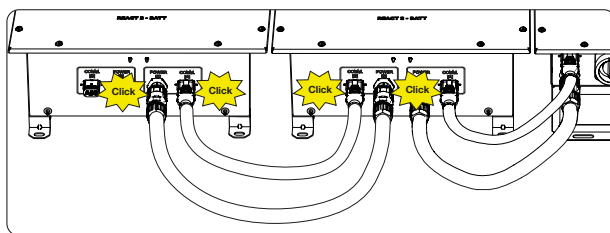

⚠ ATTENTION – To avoid risks of electrical shock and battery damage (notified by E097 error), all wiring operations must be carried out with AC disconnected and DC switch in OFF position. Faulty units are considered out of warranty.

- Connect the two battery cables between inverter and battery unit (supplied inside the REACT2-BATT box).
- Give each cable a pull test to confirm the connection is secure.

- Install an earth cable between the protective grounding connection points on the two REACT2-BATTs. To execute all external grounding connection, follow the procedure described below:
 - From among the components supplied, find the M5 nut, M5 flat washer and M5 serrated lock washer and two cable lugs. Make a jumper earth cable using the two cable lugs supplied (minimum cross-section not less than 4mm²). The cable must be long enough to connect the REACT2-BATT external protective earth [B] (24) to the REACT2-BATT external protective earth [A] (25).
 - Connect the cable on REACT2-BATT external protective earth [B] (24) of the first REACT2-BATT installed.
 - Connect the other side of the cable on REACT2-BATT external protective earth [A] (25).

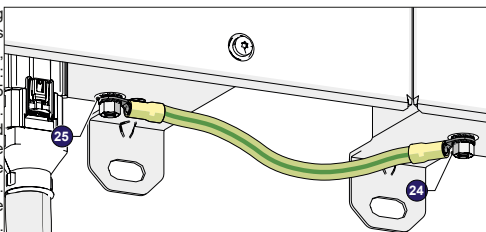

For both connection follow the below installation sequence

Installation sequence:

tooth washer

grounding jumper (one side)

Flat washer

M5 nut (torque of 4.1 Nm)

8. Connection of the energy meter

- ⚠ **WARNING** – The meter must always be protected by fuses or circuit breakers on the incoming side. It is recommended that the input voltage sensing is protected by fuses rated 6A (gL–gG type) or by circuit breakers rated 6A (B/C type) installed near the meter.
- ⚠ **WARNING** – To avoid risks of electrical shock, all wiring operations must be carried out with the AC disconnect switch (or the supply meter) upstream of the meter disconnected.

Management of the storage system in order to optimise the energy self-consumption and self-sufficiency of the REACT2 system is based on the reading of the power by the meter. On the basis of the type of electric supply the following are available:

REACT-MTR-1PH (54) for single-phase grid up to 30A.

ABB B21 (40) for single-phase grid up to 65 A.

ABB B23 (58) for three-phase grid up to 65 A (it can be used for single-phase grid if correctly installed).

ABB B24 (58) for three-phase supplies with an external current transformer (it can be used for mono-phase supplies if correctly installed).

The energy meter will communicate with the REACT2 through a dedicated serial line (RS485 METER).

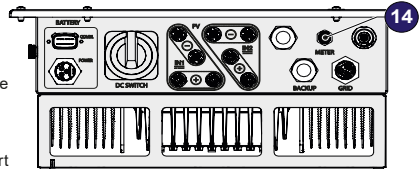
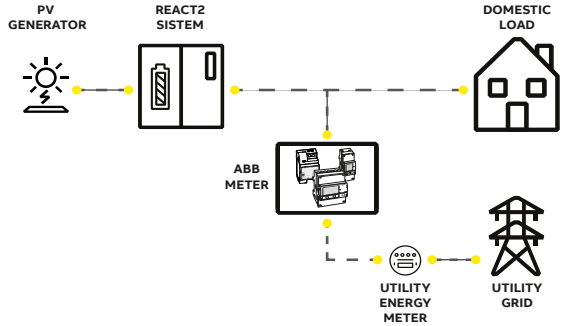

The connection of the RS485 METER line to the REACT2-UNO must be made using the dedicated METER connector (14).

In the picture below are described the components of the counterpart connector and the relative torques:

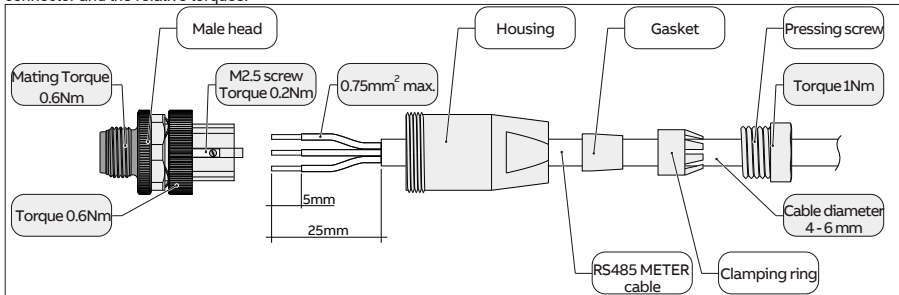

Follow the procedure to connect the RS485 cable to the counterpart (supplied) of the METER connector (14):

1. Disassembly the counterpart connector
2. Install all components on the RS485 cable
3. Strip the cable as indicated in the picture
4. Install the wire on the head of the connector following the indication below:
- z.ing of the ground cable depend on the choice of the protective earth point (internal (25) or external (10)) where it will be connected:

Screw terminal on the counterpart connector	RS485 METER signal
1	-T/R
3	+T/R
4	RTN

5. Turn the M2.5 screw with suitable screwdriver (torque 0.2Nm)
6. Install connector housing (torque 0.6Nm)
7. Install seal, pinch ring, pressing screw
8. Pressing screw should be tightened with torque 1Nm
9. Install the counterpart on the METER connector (14) by screwing the metallic ferrule (torque 0.6Nm). Give a pull test to confirm the connection is secure.

⚠ **ATTENTION** – The cable of the cable assembly must remain perpendicular to the connector and avoid an excessively sharp bend radius and loading. The maximum bend radius of a cable is ±10°.

8.1 Connection of the REACT-MTR-1PH

Connection of the REACT-MTR-1PH (single-phase):

The energy meter REACT-MTR-1PH (51) is a DIN rail device (3 modules) and must be installed where the electricity supply is single-phase

- Ensure that the AC line has been correctly disconnected upstream from the REACT-MTR-1PH. Check that there is no voltage by using a multimeter.

- Strip 8/10mm of sheathing from the connection cables of the AC power supply and connect the phase (L) and neutral (N) on the specific terminal block (53) set on the upper side of the meter; each individual terminal of the terminal block takes a cable with a maximum section from 0.5 to 4mm² (tightening torque of 0.5Nm).

- Connect the cables of the serial line (+T, -T and RTN) on the terminal block (54) (on the lower part of the REACT-MTR-1PH) respecting the correspondence between the signals of the serial line.

Serial line terminal block of the REACT-MTR-1PH (54)	Screw terminal on the counterpart connector
-T	1 (-T/R)
+T	3 (+T/R)
RTN	4 (RTN)

Each individual terminal of the terminal block takes a cable with a section from 0.14 to 1.5mm² (tightening torque of 0.5Nm).

- Subsequently the other side of the cable must be connected to the REACT2-UNO METER connector (14)
- Install the device on the DIN rail and ensure to trigger the fixing system on it
- Disconnect the phase cable (L) of the electric supply
- Insert the phase cable (L) through the hole (Ø8mm) on the REACT-MTR-1PH (51). The arrow corresponding to the hole for the feeding of the line cable (52), indicates the direction of insertion which must be complied with for correct measurement of the current; in fact the direction of the arrow indicates the supply point of the electric energy (as indicated in the diagram).

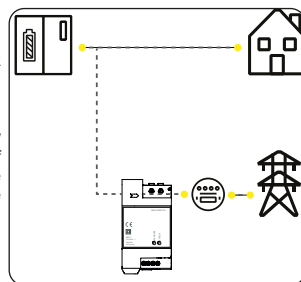

Checks for correct meter position

1 - Turn off DC switch of REACT 2

Turn off REACT 2 DC switch.

House consumption shall be greater than 50 W.

Webserver user interface shall show power coming from grid (negative value, eg: - 1250 W).

- If power is shown, ABB Meter can be in position (B) or (C) (if power sign is negative go to step 2 otherwise adjust meter orientation)
- If No power is shown (0 W). Meter is in position (A). Please install meter in the right place with correct orientation.

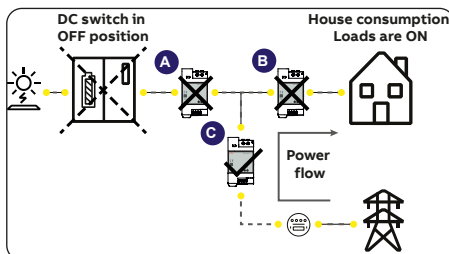

2 - Turn OFF all house loads

Turn ON DC switch of REACT 2

Turn off all the house loads.

Webserver user interface shall show power flow to the grid with positive value (eg: + 1000 W) or power flow to charge battery.

- If No Power is shown (0 W). Meter is in position (B) (WRONG). Install meter in the right one (C).
- If power is shown with positive sign (red LED MEASURE is permanently ON) the meter is in the right position (C).

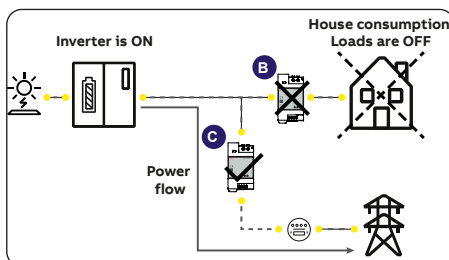

8.2 Connection and configuration of the ABB B21 meter (single-phase)

The energy meter ABB B21 (50) is a DIN rail device (2 modules) and must be installed where the electricity supply is single-phase.

- Disconnect the AC disconnect switch upstream of the meter.
- Strip the insulation of the cable for the length which is indicated on the meter (13mm).
- Connect the cables of the single-phase line in accordance with the layout printed on the meter (L and N) to the AC connection terminal block (60) (59) and tighten the screws (tightening torque 3.0 Nm).
- Connect the cables of the serial line A (37), B (36) and C (37) (set on the rear of the ABB B21 (50)) respecting the correspondence between the signals of the serial line and tighten the screws (torque 0.25 Nm):

Serial line terminal block of the meter ABB B21 (54)	Screw terminal on the counterpart connector
A (37)	1 (-T/R)
B (36)	3 (+T/R)
C (35)	4 (RTN)

- Subsequently the other side of the cable must be connected to the REACT2-UNO METER connector (14)

- Install the meter on the DIN rail and ensure to trigger the fixing system on it
- Once the phase of mechanical installation of the METER is finished, it is necessary to configure the METER in order to make it compatible with the REACT2 system. Set the parameters of the meter as set out in the table:

Parameter	Settings
Address	1
Protocol	MODBUS
Baudrate	19200
Parity	EVEN

The settings are made by using the keypad and the display on the meter:

1. Press for two seconds **[OK]** to access the setup menu of the meter.
2. Press repeatedly **[<]** until the display shows "Set".
- Press **[OK]** to confirm.
3. Press repeatedly **[<]** until the display shows "RS-485".
- Press **[OK]** to confirm.
4. Press repeatedly **[<]** until the display shows "Protocol".
- Press **[OK]** to access.
- Press **[SET]** to enable the change in the value.
- Press repeatedly **[<]** until the display shows "Modbus".
- Press **[OK]** to confirm the change.
- Press for two seconds **[OK]** to return to the RS485 menu.
5. Press repeatedly **[<]** until the display shows "Baud rate".
- Press **[OK]** to access.
- Press **[SET]** to enable the change in the value.
- Press repeatedly **[<]** and select 19200.
- Press **[OK]** to confirm the change.
- Press for two seconds **[OK]** to return to the RS485 menu.
6. Press repeatedly **[<]** until the display shows "Address".
- Press **[OK]** to access.
- Press **[SET]** to enable the change in the value.
- Press repeatedly **[<]** and select 1.
- Press **[OK]** to confirm the change.
- Press for two seconds **[OK]** to return to the RS485 menu.
7. Press repeatedly **[<]** until the display shows "Modbus".
- Press **[OK]** to access.
- Press **[SET]** to enable the change in the value.
- Press repeatedly **[<]** and select even.
- Press **[OK]** to confirm the change.

Checks for correct meter position

1 - Turn off DC switch of REACT 2

Turn off REACT 2 DC switch.

House consumption shall be greater than 50 W.

Webserver user interface and meter display shall show power coming from grid (negative value, eg: - 1250 W).

- If power is shown, ABB Meter can be in position (B) or (C) (if power sign is negative go to step 2 otherwise adjust meter orientation)

- If No power is shown (0 W). Meter is in position (A). Please install meter in the right place with correct orientation.

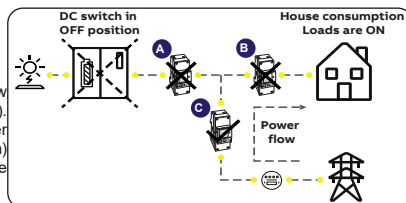

2 - Turn OFF all house loads

Turn ON DC switch of REACT 2

Turn off all the house loads.

Webserver user interface shall show power flow to the grid with positive value (eg: + 1000 W) or power flow to charge battery.

- If No Power is shown (0 W). Meter is in position (B) (WRONG). Install meter in the right one (C).

-If power is shown with positive sign the meter is in the right position (C).

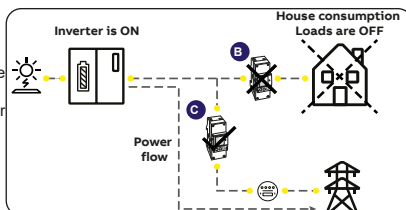

8.3 Connection and configuration of the REACT-MTR-3PH (three-phase)

The energy meter (55) is a DIN rail device (4 modules) and must be installed where the electricity supply is three-phase.

- Disconnect the AC disconnect switch upstream of the meter.
- Strip the insulation of the cable for the length which is indicated on the meter (13mm).
- Connect the cables of the three-phase line in accordance with the layout printed on the meter (L1, L2, L3 and N) to the three-phase connection terminal block (56) (59) and tighten the screws (tightening torque 2.0 Nm).

READ THE MANUAL – Take note of the phase to which the REACT2 system is connected; this information will be requested when the system is commissioned.

- Connect the cables of the serial line A (37), B (36) and C (37) on the terminal block (57) set on the rear of the meter (55) respecting the correspondence between the signals of the serial line and tighten the screws (torque 0.25 Nm) and tighten the screws (tightening torque 0.25 Nm):

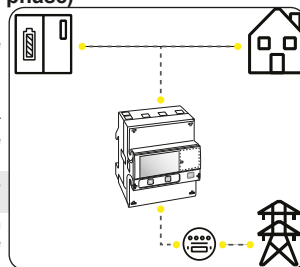

Serial line terminal block of the meter ABB B23, B24 (60)	Screw terminal on the counterpart connector
A (37)	1 (-T/R)
B (36)	3 (+T/R)
C (35)	4 (RTN)

- Subsequently the other side of the cable must be connected to the REACT2-UNO METER connector (14)
- Install the device on the DIN rail and ensure to trigger the fixing system on it
- Once the phase of mechanical installation of the METER is finished, it is necessary to configure the METER in order to make it compatible with the REACT2 system. Set the parameters of the meter as set out in the table:

Parameter	Settings
Address	1
Protocol	MODBUS
Baudrate	19200
Parity	EVEN

The settings are made by using the keypad and the display on the meter:

1. Press for two seconds **OK** to access the setup menu of the meter.
2. Press repeatedly **↔** until the display shows "Set".
- Press **OK** to confirm.
3. Press repeatedly **↔** until the display shows "RS-485".
- Press **OK** to confirm.
4. Press repeatedly **↔** until the display shows "Protocol".
- Press **OK** to access.
- Press **SET** to enable the change in the value.
- Press repeatedly **↔** until the display shows "Modbus".
- Press **OK** to confirm the change.
- Press for two seconds **OK** to return to the RS485 menu.
5. Press repeatedly **↔** until the display shows "Baud rate".
- Press **OK** to access.
- Press **SET** to enable the change in the value.
- Press repeatedly **↔** and select 19200.
- Press **OK** to confirm the change.
- Press for two seconds **OK** to return to the RS485 menu.
6. Press repeatedly **↔** until the display shows "Address".
- Press **OK** to access.
- Press **SET** to enable the change in the value.
- Press repeatedly **↔** and select 1.
- Press **OK** to confirm the change.
- Press for two seconds **OK** to return to the RS485 menu.
7. Press repeatedly **↔** until the display shows "Modbus".
- Press **OK** to access.
- Press **SET** to enable the change in the value.
- Press repeatedly **↔** and select even.
- Press **OK** to confirm the change.

Checks for correct meter position

1 - Turn off DC switch of REACT 2

Turn off REACT 2 DC switch.

House consumption shall be greater than 50 W.

Webserver user interface and meter display shall show power coming from grid (negative value, eg: - 1250 W).

- If power is shown, ABB Meter can be in position (B) or (C) (if power sign is negative go to step 2 otherwise adjust meter orientation)

- If No power is shown (0 W). Meter is in position (A). Please install meter in the right place with correct orientation.

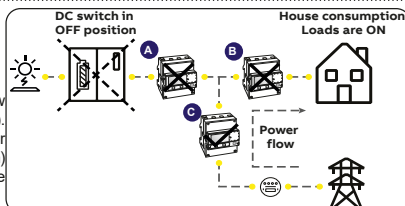

2 - Turn OFF all house loads

Turn ON DC switch of REACT 2

Turn off all the house loads.

Webserver user interface shall show power flow to the grid with positive value (eg: + 1000 W) or power flow to charge battery.

- If No Power is shown (0 W). Meter is in position (B) (WRONG). Install meter in the right one (C).

-If power is shown with positive sign the meter is in the right position (C).

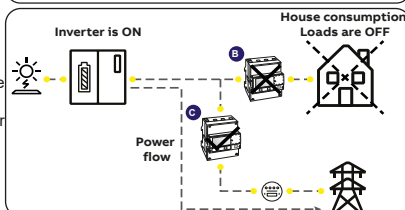

9. Line cable and protection devices

Load protection breaker (AC disconnect switch) and line cable sizing

To protect the inverter and the AC connection line, a device must be installed to protect against maximum current and leakage to ground, with the following characteristics:

	REACT2-UNO-3.6	REACT2-UNO-5.0
Type	Automatic circuit breaker with thermal-magnetic protection	
Nominal Voltage	230 Vac	
Nominal Current	25 A	32 A
Magnetic protection characteristic	B/C	
Number of poles	2	
Type of differential protection	A/AC	
Differential sensitivity	300 mA	

In case of installation of a residual current protection device must meet the following characteristics:

	REACT2-UNO-3.6	REACT2-UNO-5.0
Number of poles	2	
Type of differential protection	A/AC	
Differential sensitivity	300 mA	

FIMER declares that the FIMER transformerless inverters, in terms of their construction, do not inject continuous ground fault currents and therefore there is no requirement that the differential protection installed downstream of the inverter be type B in accordance with IEC 60755 / A 2.

Characteristics and sizing of the line cable

To connect the inverter to the grid you need 4 connections: ground, neutral, phase and external grounding protection. In any case, connection of the inverter to ground is mandatory.

The connection of the grid cable to the inverter is realised through the dedicated AC output connector (17) by carrying out the following operations:

- Characteristics and sizing of the line cable
- Installation of the cable on the AC output connector counterpart
- Connection of the AC output connector to the inverter

The cross-section of the AC line conductor must be sized in order to prevent unwanted disconnections of the inverter from the grid due to high impedance of the line that connects the inverter to the power supply point.

In order to allow installation of the grid cable inside the AC output connector (20), the sizings indicated in the figure must be observed.

The table shows the maximum line conductor length in relation to the section of the conductor itself.

Cross-section of the line conductor (mm ²)	Maximum length of the line conductor (mt)	
	REACT2-UNO-3.6	REACT2-UNO-5.0
1.5	5 m	-
2.5	10 m	6 m
4	16 m	10 m
6	24 m	16 m

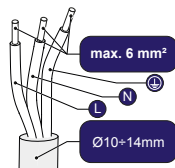

READ THE MANUAL – The values are calculated in nominal power conditions, taking into account: 1. a power loss of not more than 1% along the line. 2. copper cable, with HEPR rubber insulation, laid in free air

10. Output connection (AC)

⚠ WARNING – To avoid risks of electrical shock, all wiring operations must be carried out with the disconnect switch downstream of the inverter (grid side) opened and applying LOTO procedure on it.

Installation of the cable on the AC output connector:

- Remove the head of the connector by pressing on the two holding clips and subsequently loosen the cable gland.

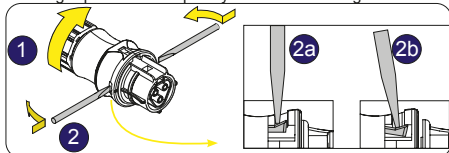

- Feed the cable through the connector and cut the cable to size. Ensure that the cable's radius of curvature is more than 4 times the diameter of the cable.

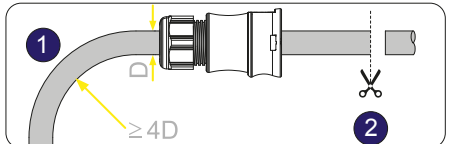

- Prepare the cable respecting the following measurements. It's possible to use both stranded or solid wire but the requirements are different. The use of stranded wire with a conductor section values between 1.5 - 4 mm² are only allowed with the mandatory use of properly crimped ferrules.

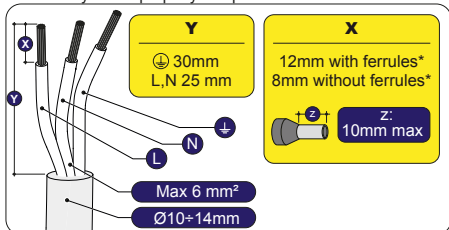

- Install the single wires (phase, neutral and ground) on the head of the connector respecting the indications printed on each of the three connection terminals (tightening torque 0.8...1Nm)

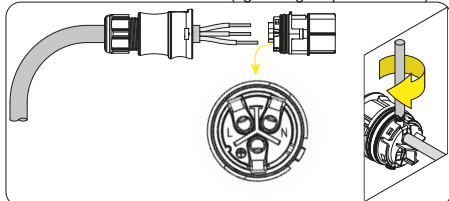

- Close the connector and tighten the cable gland respecting the tightening torque (4÷1Nm) in order to guarantee the IP65 protection level

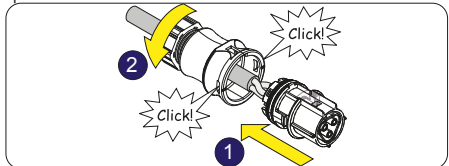

- Connection for the AC output connector to the inverter: For all inverter models, connection to the electrical grid is carried out using the AC output connector (17).

- Remove the pre-installed protective cover on the inverter by pressing on the latch with a flat screwdriver.
- Insert the counterpart in the AC output (GRID) connector (17) being careful to align the reference points (present on both connectors) which prevent connection errors.
- Push the counterpart until you hear "click"
- Give a pull test to confirm the connection is secure.

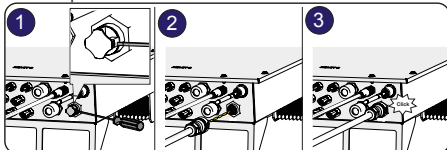

⚠ ATTENTION – In addition, the connector must not be subject to tensile forces (examples: do not connect weights to the AC cable, do not leave excess cable windings hanging, etc). In order to maintain the inverter's level of IP protection, the corresponding part must be installed with the AC cable connected or the protective cover, on the AC output connector.

- Installation of the external protective grounding cable: In addition to the grounding protection previously connected to the AC output connector (17) is necessary to:

- install a second protective grounding cable to the dedicated connection point on the metal frame (lower part) of the REACT2-UNO.
- install a jumper between the protective grounding connection points on REACT2-UNO and REACT2-BATT

To execute all external grounding connection, follow the procedure described below:

- Make a jumper earth cable using the two cable lugs supplied (minimum cross-section not less than 4mm²). The cable must be long enough to connect the REACT2-UNO external protective earth (11) to the REACT2-BATT external protective earth [A] (25)
- From among the components supplied, find the M5 nut, M5 flat washer and M5 serrated lock washer.
- Install the earth cables following the below installation sequence.

Installation sequence:

Tooth washers
external protective earth cable
jumper earth cable
flat washer
M5 nut (torque of 4.1 Nm)

- Connection on REACT2-BATT external protective earth [A] (25). Follow the below installation sequence

Installation sequence:

Tooth washers
jumper earth cable
flat washer
M5 nut (torque of 4.1 Nm)

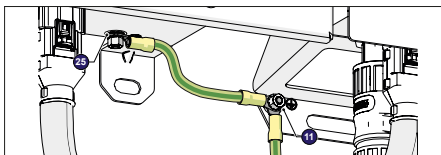

11. Backup cable and protection devices

Load protection breaker (AC disconnect switch) and cable sizing (BACKUP output)

To protect the AC connection for the the backup output of the inverter, we recommend installing a device for protection against over current and leakage with the following characteristics: FIMER declares that the FIMER transformerless inverters, in terms of their construction, do not inject continuous ground fault currents and therefore there is no requirement that the differential protection installed downstream of the inverter be type B in accordance with IEC 60755 / A 2.

REACT2-UNO-3.6/5.0	
Type	Automatic circuit breaker with differential thermal magnetic protection
Nominal Voltage	230 Vac
Nominal Current	32 A
Magnetic protection characteristic	B/C
Number of poles	2
Type of differential protection	A/AC
Differential sensitivity	30 mA

Characteristics and sizing of the cable (BACKUP output)

Three-pole cable required. The cross-section of the AC line conductor must be sized in order to prevent unwanted disconnections of the inverter from the grid due to high impedance of the line that connects the inverter to the power supply point.

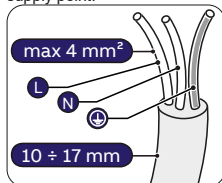

Cross-section of the line conductor (mm²)	Maximum length of the line conductor (mt)
1.5	6 m
2.5	11 m
4	19 m

The values are calculated in nominal power conditions, taking into account:

1. a power loss of not more than 1% along the line.
2. copper cable, with HEPR rubber insulation, laid in free air

12. Backup output connection (AC)

- ⚠ **WARNING** – Warning! Before performing any of the operations described below, ensure the AC line downstream the inverter has been correctly disconnected
- ⚠ **WARNING** – Warning! FIMER inverters should be earthed (PE) via the terminal with the protective earth label using a cable with an appropriate cross-section of the conductor for the maximum ground fault current that the generating system might experience

The REACT2 system is equipped with an AC BACKUP output that can be activated in different 2 ways:

- Backup Mode: AUTO
Automatic activation in case of loss of main (blackout).
- Backup Mode: External Control
Is used for activating the output:
- External command/signal (Communication and control signal terminal block (16), terminal 1-3). The selection of the backup mode is performed during the commissioning wizard.

READ THE MANUAL – See the "REACT2-Backup output use" document on the FIMER site for more information

To connect the BACKUP output of the inverter, 3 connections are necessary: ground, neutral and phase. In any case, connection of the inverter to ground is mandatory.

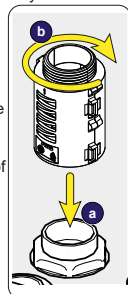

- Install the filter (supplied with the inverter) on the internal side of AC output (BACKUP) cable gland (16) (side inside the REACT2-UNO).
The installation is carried out:
- (A) position the filter on the internal side of the cable gland
- (B) Screw the filter on the thread of the cable gland

- Insert the backup cable into the REACT2 using the AC output (BACKUP) cable gland (16) (M25 with toroid) and make the connections to the AC output (BACKUP) screw terminal block (42).

Use a properly sized tripolar cable and check the tightness of the AC output (BACKUP) cable gland (16) at the end of the installation.

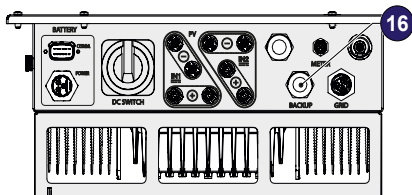

For all the models the connection is made with the AC output terminal block (42).

- Strip 10mm of sheathing from the cables and then insert into the inverter the cable, making it pass through the AC output (BACKUP) cable gland (16); the maximum diameter of the cable accepted by the cable gland is from 10 to 17 mm².
- Connect on the AC output (BACKUP) screw terminal block

(42) the ground cable (yellow-green) to protect against contact marked by the symbol Ⓢ, the neutral cable (usually blue) to the terminal marked by the letter N and the phase cable to the terminal marked by the screen-print L; every individual terminal of the terminal block accepts a cable with maximum section of 4 mm² (It is necessary to fix the AC cables to the terminal block with a tightening torque of at least 1,5 Nm).

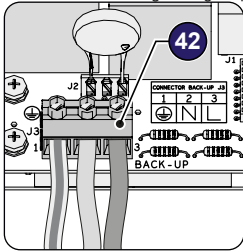

- Once the connection to the terminal block has been made, firmly screw the cable gland (7.5 Nm tightening torque and check the tightness

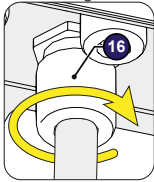

13. Input configuration (DC)

All versions of the inverter are equipped with two input channels (therefore with double maximum power point tracker MPPT) independent of each other, which can however be connected in parallel using a single MPPT.

13.1 Independent channel configuration (default configuration)

This configuration uses the two input channels (MPPT) independently.

This means that the jumper (supplied) between the positive poles of the DC (IN1 and IN2) connectors (32) must not be installed and that the mode which must be selected during the guided setup for commissioning the system is "INDEPENDENT".

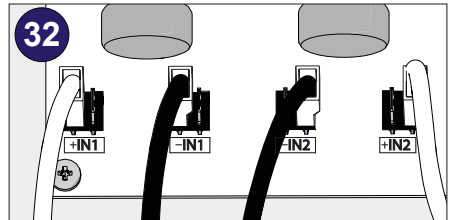
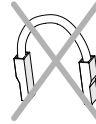

13.2 Parallel channel configuration

This configuration uses the two input channels (MPPT) connected in parallel.

This means that the jumper (supplied) between the positive poles of the DC (IN1 and IN2) connectors (32) must be installed and that the mode which must be selected during the guided setup for commissioning the system is "PARALLEL".

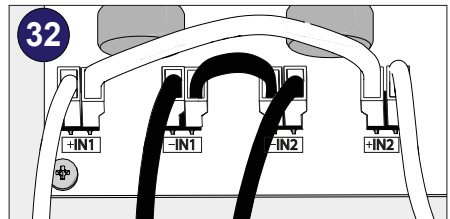

14. Input connection (DC)

⚠ WARNING – Check for correct polarity in the input strings and absence of any leakage to ground in the PV generator. When exposed to sunlight, the PV panels supply DC direct voltage to the inverter. The inside of the inverter may only be accessed after the equipment has been disconnected from the grid and from the photovoltaic generator.

⚠ WARNING – Warning! The inverters to which this document relates to are WITHOUT ISOLATION TRANSFORMER (transformer-less). This type involves the use of insulated photovoltaic panels (IEC61730 Class A Rating) and the need to maintain the photovoltaic generator floating with respect to earth: no pole of the generator must be connected to earth. To avoid risks of electrical shock, all wiring operations must be carried out with the DC disconnect switch internal and external (if present, applying LOTO procedures on it) to OFF position and with the external AC disconnect switch to OFF position (applying LOTO procedures on it).

For the connections of the strings the quick fit connectors (one for each pole of each string) located on the lower side of the REACT2-UNO are used.

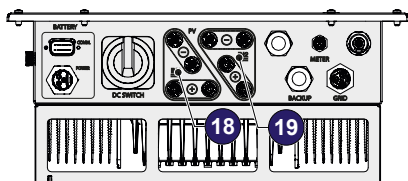

- Connect all the strings required by the system, always checking the seal of the connectors.
 - The number of connections for each input channel is 2 pairs of connectors.
- Give a pull test to confirm the connection is secure.

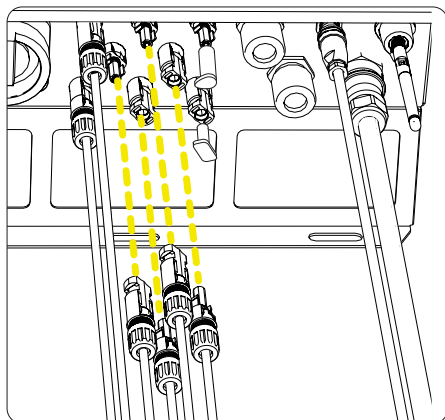

⚠ ATTENTION – Connect directly the individual input strings to the REACT2-UNO. Should it be necessary to make parallel strings outside the inverter, the maximum current allowed by the individual quick fit connector must be respected, which is 18A.

⚠ WARNING – Polarity inversion can cause serious

damage. Check polarity before connecting each string! According to the system configuration, check the correct setting of the channels to independent or in parallel mode. An incorrect setting of the input channels can lead to loss of energy production.

- If any string inputs are not required, you must ensure that covers are installed to the connectors, and install any which are missing. This is necessary both for the inverter grade IP seal, and to avoid damage to the free connector which may be used at a later time.

15. Connection of the communication and control signals

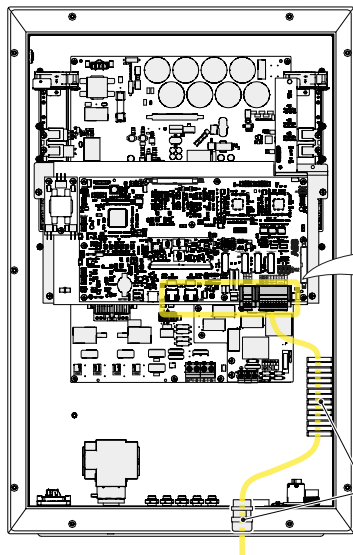

A communication and control service cable that must be connected inside the REACT2-UNO must pass through:

- the service cable gland (13).
- the cable conduit (44).

It is a M25 service cable gland (13) and can take a cable with a diameter of 10 mm to 17 mm (tightening torque 7.0Nm).

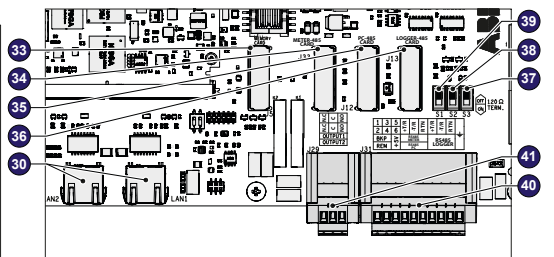

Terminal name	Terminal number	Description of communication and control signal screw terminal block (40)
BKP	1, 3	External backup command
REM	2, 4	Remote external ON/OFF command
+5V	5, 6	Auxiliary 5V positive
RS485 METER	7	+T/R RS485 METER (connected on the external meter connector 14)
	9	-T/R RS485 METER (connected on the external meter connector 14)
	11	Reference (RTN) RS485 METER (connected on the external meter connector 14)
RS485 PC (FIMER service use only)	8	+T/R of the RS485 PC communication line (FIMER service use only)
	10	-T/R of the RS485 PC communication line (FIMER service use only)
	12	Reference (RTN) of the RS485 PC communication line (FIMER service use only)
RS485 LOGGER	13, 14	+T/R of the RS485 LOGGER communication line
	15, 16	-T/R of the RS485 LOGGER communication line
	17, 18	Reference (RTN) of the RS485 LOGGER communication line
⊥	19, 20	Ground terminal

Terminal name	Terminal number	Description of multifunction relay screw terminal block (41)
OUTPUT 1	N.C.	"Normally closed" terminal of multifunctional relay (OUTPUT 1)
	C	"Common" terminal of multifunctional relay (OUTPUT 1)
	N.O.	"Normally open" terminal of multifunctional relay (OUTPUT 1)
OUTPUT 2	N.C.	"Normally closed" terminal of multifunctional relay (OUTPUT 2)
	C	"Common" terminal of multifunctional relay (OUTPUT 2)
	N.O.	"Normally open" terminal of multifunctional relay (OUTPUT 2)

Terminal name	Terminal number	Description of RJ45 (LAN) connectors (30)
LAN 1	RJ45	LAN Ethernet connector
LAN 2	RJ45	LAN Ethernet connector

READ THE MANUAL – For further information regarding the configuration and use of the communication and control signals terminal block, please see the manual

External backup command connection

The REACT2 system is equipped with a BACKUP AC output that can be activated in two different ways (Auto or via external control) settable via web server user interface.

In case of external control (BKP terminals) selection, backup output is activated when terminal 1 is brought to the same potential as terminal 3 (i.e. positioning a switch to create a short circuit between the two terminals).

Remote control connection (REM)

The connection and disconnection of the inverter to and from the grid can be controlled through an external control. The function must be enabled via web server user interface. If the remote control function is disabled, the switching on of the inverter is dictated by the presence of the normal parameters that allow the inverter to connect to the grid.

If the remote control function is on, besides being dictated by the presence of the normal parameters that allow the inverter to connect to the grid, switching on the inverter also depends on the state of REM terminals (terminal 2 and terminal 4) on the communication and control signal terminal block (40).

When terminal 2 is brought to the same potential as terminal 4 (i.e. positioning a switch to create a short circuit between the two terminals), the inverter is disconnected from the grid.

+5V output connection

On the communication and control signal terminal block (21) there is auxiliary voltage of +5V.

The maximum absorption permitted from this auxiliary power supply voltage is 100 mA.

Connection of RS485 LOGGER serial communication line

The RS485 LOGGER serial communication line on the communication and control signal terminal block (40) is reserved for the connection of the inverter to monitoring devices that communicate with the Modbus communication protocol. On the communication and control signal terminal block (40) there are two connection points for each serial line signal (+T/R, -T/R and RTN) so as to be able to make a daisy-chain connection ("in-out") of multiple inverters.

Connection of a monitoring system to the RS485 LOGGER communication line consists of first connecting all the units in the chain in the "daisy-chain" ("in-out") configuration, respecting corresponding signals, and then activating the communication line termination resistance in the last element in the chain by setting the RS485-LOGGER line termination switch (37) (to the ON position).

⚠ ATTENTION – For long distance connections, it is preferable to use a shielded twisted pair cable with characteristic impedance of Z0=120 Ohm like the one shown in the following table:

Signal	Symbol
Positive data	+T/R
Negative data	-T/R
Reference	RTN
Shield	

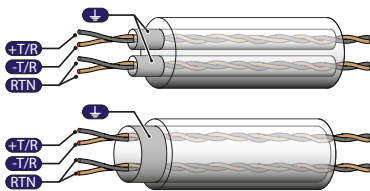

Configurable Relay connection (OUTPUT 1 and OUTPUT 2)

The inverter is equipped with 2 multifunction relays with configurable activation. It can be connected with normally open contact (being connected between the NO terminal and the common contact C) and with normally closed contact (being connected between the NC terminal and the common contact C).

This multifunction relays can be used in different operating configurations that can be selected by accessing the web server user interface. Different types of devices (light, sound, etc.) can be connected to the relay, provided they comply with the following requirements:

- Alternating current: Maximum Voltage: 240 Vac / Maximum Current: 1 A
- Direct current: Maximum Voltage: 30 Vdc / Maximum Current: 0.8 A
- Cable requirements: Conductor cross-section: from 0.14 to 1.5 mm²

⚠ ATTENTION – The ALARM contact can be used only with systems that ensure a safety isolating additional at least (supplementary insulation in relation to the DC input voltage)

Ethernet connection

The ethernet connection allows a direct data transfer to the FIMER server for monitoring purpose.

When the inverter will be powered on, network parameters are automatically set and the inverter starts transmitting telemetry data to the Aurora Vision® CLOUD platform.

The connection of the ethernet communication cable must be made on the specific connectors (30) located on the communication and control board inside the REACT2-UNO (02). If the inverters of the plant need to be connected in daisy chain or ring configuration use both connectors.

The cable should be compliant to the following specification:

- Cable type: Patch or Cross type, 100BaseTx, CAT5e (or higher) with shielding STP or FTP.
- UV-resistant if used outdoors
- Type of plug: metallic shielded RJ45
- The maximum length that can reach these cables is 100 meters, and it is always advisable not to let them pass by the power cords to avoid interference with data transmission.
- Maximum inverters number connected over one single daisy chain is 40.

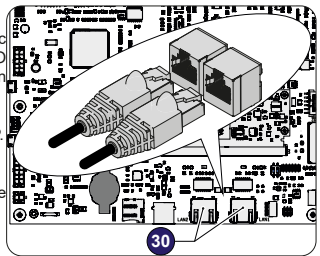

ATTENTION – In order to avoid ground loop (that could create communication issues) the shield of any Ethernet cable must be connected to the RJ45 plug in only one side, the other side of the shield should be leaved floating. This could be guaranteed by crimping the shield or the screen of the ethernet cable to the RJ45 connectors only at one end of each cables.

Three topologies of ethernet connection to the router are available:

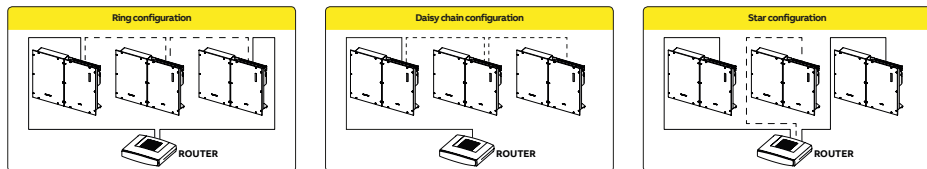

The ring configuration is the preferable way to connect the units in order to allow reaching inverters in case of single inverter fault. In case inverters are connected to the networking switch with a ring topology is recommended to enable SPT protocol on the switch

On each configuration of connection the maximum length of the cable must be 100m maximum between inverter – inverter and inverter – switch.

Please refer to Aurora Vision documents available on FIMER website for further information how to get an Aurora Vision account for remotely monitoring and managing the installed solar assets.

16. Description of the synoptic

The synoptic (03) functions on the inverter are described below.

Synoptic icon	Description
	Indicates the status of the inverter's grid connection
	Indicates the status of the WI-FI or ETHERNET communication lines.
	Communication status with external meter
	Communication status with batteries
	Indicates that the inverter has detected an anomaly. The type of problem is highlighted in the Web User Interface .
	The "GFI" (ground fault) LED indicates that the inverter has detected a ground fault in the DC side photovoltaic generator.

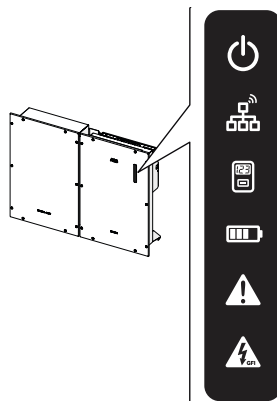

The icons of the synoptic (03) on the front panel can behave in different ways depending on the inverter's operating state.

All possible icon activation combinations are shown in the following table. In particular, each icon could behave in one of the following ways:

- = icon on
- = icon flashing (slow)
- = icon flashing (fast)
- = icon off
- = Any one of the conditions described above

Icon status	Operating state
	Wireless not configured or/and Ethernet cable not connected.
	Scanning for available wireless networks.
	Trying to connect to a network (wifi or ethernet)
	Inverter is connected to the network via wifi or ethernet

Icon status		Operating state
		Wireless not configured or/and Ethernet cable not connected.
		Scanning for available wireless networks.
		Trying to connect to a network (wifi or ethernet)
Icon status		Operating state
		No battery has been commissioned
		Charging
		Discharging
		Idle - sleep
		Fault
		End of battery life reached
Icon status		Operating state
		Firmware programming
		The inverter firmware is being programmed
		Night mode (inverter automatically switches off)
		The inverter is in night time switch-off mode (input voltage less than 70% of the set start-up voltage).
		Inverter initialisation
		This is a transitional state due to the verification of the operating conditions. During this stage the inverter checks that the conditions for connecting to the grid are met.
		The inverter is connected and feeds power into the grid
		Normal operation. During this stage, the inverter automatically tracks and analyses the photovoltaic generator's maximum power point (MPP).
		Disconnection from the grid
		Indicates no grid voltage. This condition does not allow the inverter to connect to the grid
		Indication of Warning (W message codes) or Error E warning codes
		Indicates that the inverter control system has detected a warning (W) or error (E).
		Backup operating modes
		Depending on the different modes that can be set, and after detecting the conditions required for the output to be enabled, the system went into backup operation
		Blackstart operating mode
		Ventilation anomaly
		Indicates an anomaly in the operation of the internal ventilation system that could limit output power at high ambient temperatures.
		Failed association of internal inverter components (after replacement)
		Indicates that the installed wiring box (only if replacing the inverter) was already associated with another inverter and that it cannot be associated with the new inverter.
		Overvoltage surge arresters triggered (where fitted)
		Indicates that any class II overvoltage surge arresters installed on the AC or DC side have been triggered
		String protection fuses triggered (where fitted)
		Indicates that one or more input string protection fuses that may be installed have been triggered
		Autotest (for Italian grid standards only) The inverter is performing an Autotest
		Anomaly in the insulation system of the photovoltaic generator
		Indicates that a leakage to ground from the PV generator has been detected, causing the inverter to disconnect from the grid.
		Indicates an operating anomaly in the battery unit

17. Commissioning

- ⚠ ATTENTION** – Before proceeding with commissioning, make sure you have carried out all the following checks:
- Check the correct connection and polarity of the DC inputs, and the correct connection of the AC output and ground cables.
 - Check the correct connection of the power and signal cables between REACT2-UNO and REACT2-BATT
 - Check the sealing barrier of the cable ducts and installed quick-fit connectors to prevent accidental disconnections and/or avoid compromising the IP65 environmental protection rating.

Commissioning is carried out via Wi-Fi connection to the REACT2's internal web user interface. Initial setup of the REACT2 system must therefore be carried out via a tablet, notebook or smartphone with a Wi-Fi connection.

To establish the connection and operate with the REACT2, it is necessary to power up the inverter by connecting its input to the DC voltage of the photovoltaic panels or its output to the AC grid.

- Supply the inverter with DC input voltage from the photovoltaic generator and/or via AC GRID voltage.

- ⚠ ATTENTION** – Where the system is powered by the photovoltaic generator (DC) make sure irradiation is stable and adequate for the REACT2's commissioning procedure to be completed.

• Pre-commissioning phase 1 - Connection to the local Wi-Fi network

- DEVICE USED TABLET/SMARTPHONE.

Once powered, launch a QR reader for mobile and SCAN the QR code marked with 1  on the label on the right side of the inverter and connect to inverter network (tap connect).

The name of the Wi-Fi network created by the system, that the connection should be established with, will be:

ABB-XX-XX-XX-XX-XX-XX (where the X is the MAC address)

After this step wait 10 seconds to allow the WLAN connection

SN WLAN: SSSSSSSSSS
 PN WLAN: PPP.PPPPP.PP
 MAC: XX:XX:XX:XX:XX:XX

Remove and apply
 on the Quick
 installation guide



SN Inverter: SSSSSSSSSS
 MAC: XX:XX:XX:XX:XX:XX
 PK: KKKK-KKKK-KKKK-KKKK

- DEVICE USED LAPTOP.

Enable the wireless on the device you are using for the commissioning and search for the network named ABB-XX-XX-XX-XX-XX-XX, where "X" is a hexadecimal number of the MAC Address (the MAC Address is indicated on the "wireless identification label" on the side of the inverter).

When prompted, type the PK (product key), including the dashes. Example: 1234-1234-1234-1234 as the network password.

• Pre-commissioning phase 2 - Internal web UI access

- DEVICE USED TABLET/SMARTPHONE.

SCAN this QR code. An internet browser page showing the step by step procedure will be open.



- 📖 READ THE MANUAL** – The information contained in this QR code is the IP address of the web user interface of the inverter: <http://192.168.117.1>.

Recommended browsers: Chrome from v.55, Firefox from v.50, Safari from V.10.2.1

- DEVICE USED LAPTOP.

Open an internet browser page and insert <http://192.168.117.1> on the address bar.

STEP BY STEP COMMISSIONING WIZARD:

READ THE MANUAL – The screens shown below pertain to a tablet with the Android operating system. Screens on other devices or operating systems may differ.

STEP 1 - Administrator/User login credentials

- Set the Administrator account user and password (minimum 8 character for password): Administrator account can open and view the contents of photovoltaic site. Additionally, they can make changes to inverter settings. User and password are CASE SENSITIVE.
- Set the User account name and (optional) password (minimum 8 character for password): User account can only read data. It cannot make any changes. User and password are CASE SENSITIVE.
- Click on "Next" button to proceed to the next stage of the configuration wizard.

STEP 2 (Optional) - Residential wireless network connection.

The parameters relating to the home wireless network (set on the router) that must be known and set during this step are:

- IP Settings: DHCP or Static.
If you select the DHCP function (default setup) the router will automatically assign a dynamic IP address to the inverter whenever it tries to connect to the user network. With Static, the user can assign a fixed IP address to the system. The data which has to be entered in order for IP static address assigning to take place will appear. Complete the additional fields at the bottom of the screen (all the fields are mandatory with the exception of the secondary DNS server).

- Available networks (SSID): Identify and select your own (home) wireless network from all those shown in the SSID field (you can carry out a new search of the networks that can be detected with the Update button).

Once the network has been selected, confirm.

- Password: Wireless network password.
Enter the password for the destination network (if necessary) and start the connection attempt (it will take a few seconds).

- Click on "Connect" button to connect the inverter to the home wireless network.

- A message will ask for confirmation. Click "Next" to connect the inverter to the home wireless network.

• Once the inverter is connected to the domestic wireless network, a new message will confirm that. The message provides the IP Address assigned by the home wireless network router to the inverter that can be used each time you want to access the internal webserver, with the inverter connected to the home wireless network. Take note of it.

• Click on "Next" button to proceed to the next stage of the configuration wizard.

 **READ THE MANUAL** – The IP address assigned may vary for reasons connected to the wireless home router setup (for example, a very brief DHCP lease time). If verification of the address is required, it is usually possible to obtain the client list (and the corresponding IP addresses) from the wireless router administration panel.

If the inverter loses the connection with the home wireless network, it is available accessing the Wi-Fi network
ABB-XX-XX-XX-XX-XX-XX, where "X" is an hexadecimal number of the MAC Address.

 **READ THE MANUAL** – The most common causes of losing connectivity might be: different wireless network password, faulty or unreachable router, replacement of router (different SSID) without the necessary setting updates.

Wireless network
connection **succeeded**:

Home-Network

The inverter has been successfully connected to the wireless network **Home-Network**

The connection to the wireless network **Home-Network** succeeded.

IP address: 10.38.34.186

Please take note of the address.

Back

Next

STEP 3 - Date, Time and Time zone

• Set the Date, Time and Time zone (The inverter will propose these fields when available). When it's not possible for the inverter to detect the time protocol, these fields have to be manually entered.

• Click on "Next" button to proceed to the next stage of the configuration wizard.

Date and Time

A NTP server has been detected and it will be used to keep the system clock synchronized.

Date

May 13, 2021

SET by the NTP server

Time

3:45 PM

SET by the NTP server

Time Zone

Europe/Berlin GMT+01:00

Save

STEP 4 - Type of coupling, Inverter country standard, Input mode, Meter and Energy policy, Battery and Backup mode configuration

System configuration

- DC coupled (new installations). Select this mode if the inverter is connected to the AC network and to the photovoltaic generator.
- AC coupled (retrofit with existing solar inverters). Select this mode if the inverter is connected only to the AC network and in combination with a standard inverter connected to the photovoltaic generator.

Country standard

• Set the grid standard of the country in which the inverter is installed.

 **ATTENTION** – From the moment that the grid standard is set, you have 24 hours to make any changes to the value, after which the "Country Select > Set Std." functionality is blocked, and the remaining time will have to be reset in order to have the 24 hours of operation available again in which to select a new grid standard (follow the procedure "Resetting the remaining time for grid standard variation" described in the relevant section).

Input mode (not available if "AC coupled" system configuration was selected)

- Independent
- Parallel

See the relevant section of this guide to know how to physically set the input mode

Meter

When a meter device is connected to the inverter, it's requested to select the meter model:

- Meter Model:
 - None (where system is installed without meter)
 - REACT-MTR-1PH (single-phase)
 - ABB 3PH (three-phase)
 - ABB 1PH (single-phase)

 **READ THE MANUAL** – If a 3PH energy meter (ABB B23, B24) is used in the system as single-phase inverter, it will be necessary to select ABB 3PH and the phase to which the inverter is connected.

If the selected meter is three-phase additional requested fields will appear:

- Meter Phase: select the phase to which the inverter is connected.

When a meter type is selected is possible to set also the Energy Policy fields that allows to manage the energy produced by the PV plant.

DC Coupled AC Coupled

Country standard

Select the country standard (grid code)

-- Please select --

Required

Input mode

PV Input Channels Configuration

Independent

Meter

Meter model

none

Battery

- Battery Type. Select REACT2-BATT if at least one battery is present; otherwise select NONE.
- Number. Set the number of REACT2-BATT (battery unit) installed.

Energy Policy

- Energy Policy: set the way to manage the energy produced by the PV plant, choosing from the following:

Management mode	Description
Zero injection	The system automatically manages power flows in order to avoid the injection of energy to the grid. If the meter is disconnected or not working the inverter's output power is restricted to zero in order to avoid accidental power feeding to the grid.
Self consumption	The system automatically manages power flows in order to maximise self-consumption. All unused power from domestic loads will feed into the grid.
Backup only (visible only if "AUTO" or "External Control" option is selected in the "Backup Mode" section)	backup only: the battery has priority over the loads, so it is kept charged until the backup output is activated.
Custom	The system automatically manages power flows in order to avoid feeding the grid with power greater than: $PDC \times Plim$ where PDC is the power of the photovoltaic generator ("PV GENERATOR POWER" parameter) and Plim is the output power limit with respect to PDC(%) ("FEED-IN POWER" parameter). - PV Generator Power (Wp): Insert the power value of the photovoltaic system installed. - Feed-in Power (% PV Generator Power): Set the percentage AC power restriction (with reference to the value of the photovoltaic system (kWp) installed) to be feed into the grid.

- Backup Mode:
Set the way to manage the backup functionality, choosing from:
AUTO. The necessary condition for activating the backup function is the lack of grid.
External Control. The backup function is controlled by an external command.

- Confirm the settings by clicking "DONE" and the inverter will test the meter and the battery working and it will reboot at the finish of test phase.

- A notification will confirm that the wizard is completed.

- After the wizard is completed, the system will power-on. The inverter checks the grid voltage, measures the insulation resistance of the photovoltaic field with respect to ground and performs other auto-diagnostic checks. During the preliminary checks on the parallel connection with the grid, the "Power" LED keeps flashing, the "Alarm" and "GFI" LEDs are off. If the outcome of the preliminary checks on the grid parallel is positive, the inverter connects to the grid and starts to export power to the grid. The "Power" LED remains fixed on while the "Alarm" and "GFI" LEDs are off.

📖 READ THE MANUAL – To address any problems that may occur during the initial stages of operation of the system and to ensure the inverter remains fully functional, you are advised to check for any firmware updates in the download area of the website www.fimer.com or at <https://registration.solar.fimer.com/> (instructions for registering on the website and updating the firmware are given in this manual).

Battery

Battery Type
 REACT2-BATT

Number
 1

Energy Policy
 Energy Policy
 -- Please select --

Backup Mode
 None

The inverter will be rebooted after the country standard change. The procedure may take several minutes.

Wizard completed

Congratulations wizard successfully completed

Wireless channel 1
 You are connected through the channel 1 (Access Point)

SSID: ABB-f0-b5-d1-d7-of-43
 IP: 192.168.117.1

Wireless channel 2
 Connected to: Home-Network
 IP: 10.38.34.186

18. Characteristics and technical data

System components of REACT2 photovoltaic system with storage	REACT2-3.6-TL-OUTD	REACT2-5.0-TL-OUTD
Inverter unit	REACT2-UNO-3.6-TL	REACT2-UNO-5.0-TL
Battery unit	REACT2-BATT	
Energy meter	REACT-MTR-1PH; ABB B21-212; ABB B23-212; ABB B24-212	
Inverter	REACT2-UNO-3.6-TL	REACT2-UNO-5.0-TL
PV port		
Absolute maximum DC input voltage (V _{dc, max})	575 V	
Start-up DC input voltage (V _{start})	200 V (adj. 120...350 V)	
Operating DC input voltage range (V _{dcmín...V_{dc}max})	0.7 x V _{start} ...575 V (min 90 V)	
Rated DC input voltage (V _{dcr})	390 V	
Rated DC input power (P _{dcr})	5000 W	6000 W
Number of Independent MPPT	2	
Maximum DC input power for each MPPT (P _{MPPTmax})	2500W Linear derating [480 V≤V _{MPPT} ≤575 V]	3000W Linear derating [480 V≤V _{MPPT} ≤575 V]
DC input voltage range with parallel configuration of MPPT at Pacr, not operative battery	160 V...480 V	195 V...480 V
Maximum DC input current (I _{dc max}) / for each MPPT (I _{MPPTmax})	24 A / 12 A	27 A / 13.5 A
Maximum input short circuit current for each MPPT (I _{scmax})	15 A	
Maximum Return current (AC side vs DC side)	Negligible in normal operating conditions ⁽⁶⁾	
Number of DC input connection pairs for each MPPT	2	
DC connection type	Quick-fit PV connector ⁽⁹⁾	
PV port protection		
Reverse polarity protection	Yes, from current limited source	
Input overvoltage protection for each MPPT - varistor	Yes	
Photovoltaic array isolation control	According to local standard	
DC switch rating for each MPPT	25 A / 575 V	
Output AC port		
AC grid connection type	Single-phase	
Rated AC power (P _{ac} @cosφ=1)	3600 W	5000 W ⁽²⁾
Maximum AC output power (P _{acmax} @cosφ=1)	3600 W	5000 W ⁽²⁾
Maximum apparent power (S _{max})	3600 VA	5000 VA ⁽²⁾
Rated AC grid voltage (V _{ac,r})	230 V	
AC voltage range	180...264 V (3)	
Maximum AC output current (I _{ac,max})	16 A	22 A
Contributory fault current	16A	22A
Inrush current	Negligible	
Rated output frequency (f _r)	50 Hz / 60 Hz	
Output frequency range (f _{min} ...f _{max})	45...55 Hz / 55...65 Hz (4)	
Nominal power factor and adjustable range	> 0.995, adj. ± 0.1 - 1 (over/under excited)	
Total current harmonic distortion	<3%	
AC connections type	Panel connector	
Output AC port protection		
Anti-islanding protection	According to local standard	
Maximum external AC overcurrent protection	20 A	25 A
Output overvoltage protection - varistor	2 (L - N / L - PE)	

Backup output port	REACT2-UNO-3.6-TL	REACT2-UNO-5.0-TL
AC grid connection type	Single-phase	
Maximum apparent power (S _{max})	3000 VA	
Rated AC grid Voltage (V _{acr})	230 V	
AC Voltage range	180...264 V ⁽³⁾	
Maximum AC output current (I _{ac max})	13 A	
Rated output frequency (f _r)	50 Hz / 60 Hz	
Output frequency range (f _{min} ...f _{max})	45...55 Hz / 55...65 Hz ⁽⁴⁾	
AC connections type	Screw terminal block	
Backup output protection		
Maximum external AC overcurrent protection	16 A	
Output overvoltage protection - varistor	2 (L-N/L-PE)	
Input AC port		
AC voltage range	230 V	
Maximum AC input current (I _{ac max})	16 A	22 A
Inrush current	Negligible	
Rated output frequency (f _r)	50 Hz / 60 Hz	
Battery port		
Operating DC input voltage range (V _{dcm} in...V _{dcm} ax)	170 V...575 V	
Maximum DC charge current (I _{dc,max charge})	13.5 A	13.5 A
Rated AC grid Voltage (V _{acr})	10 A	10 A
Operating performance		
Maximum efficiency (η _{max})	97.1%	
Weighted efficiency (EURO/CEC)	96.3% / -	96.6% / -
Embedded communication		
Embedded physical interface	Wireless ⁽⁵⁾ , 2 x Ethernet, RS485	
Embedded communication protocols	Modbus TCP (SunSpec), Modbus RTU (Sunspec), ABB-free@home ⁽⁶⁾	
Datalogger data retention	30 days	
Remote monitoring	Mobile app	
Local monitoring	Web server user interface	
Environmental		
Ambient temperature range	-20...+55°C with derating above 50°C	-20...+55°C with derating above 45°C
Relative humidity	4...100 % condensing	
Acoustic noise emission level	< 50 dB (A) @ 1 m	
Maximum operating altitude without derating	2000 m / 6560 ft	
Environmental pollution degree classification for external environments	3	
Environmental class	Outdoor	
Suitable for wet location	Yes	
Physical		
Environmental protection rating	IP65	
Cooling	Natural	
Dimension (H x W x D)	740 mm x 490 mm x 229 mm	
Weight	< 22 kg	
Mounting system	Wall bracket	
Overvoltage rating as per IEC 62109-1	II (DC input) III (AC output)	
Safety		
Safety class	I	
Insulation level	Transformerless	
Marking	CE ⁽⁷⁾	
Safety and EMC Standards	IEC/EN 62109-1, IEC/EN 62109-2, EN 61000-6-2, EN 61000-6-3, EN 61000-3-2, EN 61000-3-3, EN61000-3-11, EN61000-3-12	
Grid standard (check your sales channel for availability)	CEI 0-21, DIN V VDE V 0126-1-1, VDE-AR-N 4105, G83/2, G59/3, RD 413, AS/NZS 4777.2,C10/11, IEC 61727, IEC 62116	

Other features

Load manager	Yes, with two integrated relays
AC backup output, off grid	Yes
Battery charge from AC	Yes, it can be enabled
AC-coupled	Yes

Battery Unit**REACT2-BATT**

Modules manufacturer	Samsung
Battery type	Li-Ion
Total energy	4 kWh
Maximum battery voltage (Vdc max)	575 V
Battery voltage range (Vdc operating range)	170...575 V
Maximum DC charge current (Idc max charge)	4.5 A for each battery installed
Maximum DC discharge current (Idc,max discharge)	5.6 A for each battery installed
Deep of discharge (DoD)	95%
N° of battery unit that can be connected to the REACT2-UNO inverter	1, 2, 3
Charge power	1.6 kW, 3.2 kW, 4.8 kW
Discharge power	2 kW, 3.6 kW, 3.6 kW (REACT2-3.6-TL-OUTD) 2 kW, 4 kW, 5 kW (REACT2-5.0-TL-OUTD)

Environmental

Environmental protection rating	IP54 (suggested indoor installation for preserving battery life time)
Ambient temperature range	-20...+55°C (out of 0...+40°C temperature range, battery will be disabled)
Suggested ambient temperature	+5...+30°C
Storage temperature	-20...+25°C (6 months) or -20...+45°C (3 months)
Relative humidity	4...100 % condensing

Physical

Cooling	Natural
Dimension (H x W x D)	740 mm x 490 mm x 229 mm
Weight	50 kg
Mounting system	Wall bracket

Safety

Protective class	I
Marking	CE
Safety	IEC 62619, UN38.3, UN3480

Energy meter

REACT-MTR-1PH	Single-phase, 20A
ABB B21-212	Single-phase, 65A
ABB B23-212	Three-phase, 65A
ABB B24-212	Three-phase with external CT (opt.)

- 1) Refer to the document "String inverter – Product Manual appendix" available at www.abb.com/ solarinverters to know the brand and the model of the quick fit connector"
- 2) For VDE-AR-N 4105 setting, maximum active power of 4600 W and maximum apparent power of 4600 VA
- 3) The AC voltage range may vary depending on specific country grid standard
- 4) The Frequency range may vary depending on specific country grid standard
- 5) As per IEEE 802.11 b/g/n standard
- 6) In the event of a fault, limited by the external protection envisaged on the AC circuit
- 7) Hereby, Fimer S.p.A. declares that the radio equipments (radio module combined with the inverter), to which this user manual refers, are in compliance with the Directive 2014/53/EU. The full text of the EU Declaration of Conformity is available at the following internet address: www.fimer.com

Remark. Features not specifically listed in the present data sheet are not included in the product

ENGLISH



The symbol of the crossed-out wheeled bin identifies electrical and electronic equipment (EEE) placed on the market after 13 August 2005 which should be separately collected in accordance with the Directive 2012/19/EU of the European Parliament and of the Council on waste electrical and electronic equipment (WEEE).

Users of EEE from private households (consumers) within each European Union country:

Electrical and electronic equipment should be disposed of in appropriate collection facilities as set up by the competent authorities within each Member State or in accordance with that Member State's national regulations regarding WEEE collection and disposal.

Professional users (Companies - Enterprises) within each European Union country: Electrical and electronic equipment should be disposed of in accordance with the Member State's national regulations regarding WEEE collection and disposal. Further information should be obtained from the reseller or local vendor.

Both Private and Professional Users from EEEs outside the European Union: Electrical and electronic equipment should be disposed of in accordance with the Member State's national regulations regarding WEEE collection and disposal. Inappropriate EEE disposal could have a negative environmental impact and hamper human health. Cooperating in the appropriate disposal of this product contributes to product reuse and recycling, while protecting our environment.

ITALIANO



Il simbolo del contenitore di spazzatura su ruote barrato, accompagnato da una barra piena orizzontale, identifica le apparecchiature elettriche ed elettroniche, immesse sul mercato dopo il 13 agosto 2005, oggetto di raccolta separata in conformità alla Direttiva Europea 2012/19/UE (WEEE Directive).

Utenti domestici (privati cittadini) della Comunità Europea:

Lo smaltimento di questa apparecchiatura elettrica ed elettronica deve avvenire presso le isole ecologiche messe a disposizione dagli enti locali o comunque seguendo le indicazioni delle autorità locali per la raccolta differenziata dei rifiuti elettronici.

Utenti professionali (Aziende-Imprese) della Comunità Europea: Lo smaltimento di questa apparecchiatura elettrica ed elettronica deve avvenire in conformità alle legislazioni locali. Contattare il rivenditore o il fornitore locale per ulteriori informazioni.

Utenti domestici e professionali in altri paesi fuori dalla Comunità Europea:

Lo smaltimento di questa apparecchiatura elettrica ed elettronica deve avvenire in conformità alla legislazione locale. Contattare il rivenditore o il fornitore locale per ulteriori informazioni. Collaborando allo smaltimento corretto di questo prodotto, si contribuisce al riutilizzo, al riciclaggio e al recupero del prodotto, e alla protezione del nostro ambiente.

DEUTSCH



Mit dem Symbol der ausgekreuzten Mülltonne werden Elektro- und Elektronikgeräte gekennzeichnet, die nach dem 13. August 2005 auf den Markt gebracht wurden und in Einklang mit der Richtlinie 2012/19/EU des Europäischen Parlaments über Elektro- und Elektronik-Abfälle (WEEE) getrennt zu sammeln sind.

Benutzer von Elektro- und Elektronikgeräten aus privaten Haushalten (Konsumenten) in den Mitgliedstaaten der Europäischen Union: Elektro- und Elektronikgeräte sind bei einer hierfür von den zuständigen Behörden eingerichteten geeigneten Annahmestelle im jeweiligen Mitgliedstaat abzugeben oder in Einklang mit den nationalen Bestimmungen des Mitgliedstaats hinsichtlich der Sammlung und Entsorgung von Elektro- und Elektronikgeräten gemäß der WEEE-Richtlinie zu entsorgen.

Professionelle Benutzer (Unternehmen) in den Mitgliedstaaten der Europäischen Union: Elektro- und Elektronikgeräte sind in Einklang mit den nationalen Bestimmungen des Mitgliedstaats hinsichtlich der Sammlung und Entsorgung von Elektro- und Elektronikgeräten gemäß der WEEE-Richtlinie zu entsorgen. Für nähere Informationen wenden Sie sich bitte an den Wiederverkäufer oder Ihren Händler vor Ort.

Sowohl private als auch professionelle Benutzer in den Mitgliedstaaten der Europäischen Union: Elektro- und Elektronikgeräte sind in Einklang mit den nationalen Bestimmungen des Mitgliedstaats hinsichtlich der Sammlung und Entsorgung von Elektro- und Elektronikgeräten gemäß der WEEE-Richtlinie zu entsorgen. Bei unsachgemäßer Entsorgung besteht das Risiko nachteiliger Auswirkungen auf Umwelt und Gesundheit. Durch Ihre Kooperation zur ordnungsgemäßen Entsorgung fördern Sie das Wiederverwendung und das Recycling des Produkts und tragen zum Umweltschutz bei.

ESPAÑOL



El símbolo del contenedor de basura tachado con un aspa indica aquellos aparatos eléctricos y electrónicos (AEE, EEE por sus siglas en inglés) lanzados al mercado después del 13 de agosto de 2005 que deben recogerse de forma separada de acuerdo con la Directiva 2012/19/UE del Parlamento Europeo y el Consejo Europeo sobre residuos de aparatos eléctricos y electrónicos (RAEE).

Usuarios particulares de AEE (consumidores) en cada uno de los países de la Unión Europea: Los aparatos eléctricos y electrónicos deben eliminarse en los puntos de recolección adecuados establecidos por las autoridades competentes de cada Estado miembro de acuerdo con las normativas nacionales de dicho Estado miembro sobre la recolección y eliminación de RAEE.

Usuarios profesionales (Empresas e Industrias) en cada uno de los países de la Unión Europea: Los aparatos eléctricos y electrónicos deben eliminarse de acuerdo con las normativas nacionales sobre la recolección y eliminación de RAEE. Puede obtener más información en su distribuidor o proveedor local.

Usuarios particulares y profesionales de países no pertenecientes a la Unión Europea: Los aparatos eléctricos y electrónicos deben eliminarse de acuerdo con las normativas nacionales sobre la recolección y eliminación de RAEE. La eliminación inadecuada de un AEE puede tener un impacto negativo en el medio ambiente y perjudicar la salud humana. Su cooperación en la eliminación adecuada de este producto contribuye a su reutilización y reciclado a la vez que protege el medio ambiente.

FRANÇAIS



Le symbole de poubelle interdite identifie les équipements électriques et électroniques (EEE) mis sur le marché après le 13 août 2005 qui doivent être collectés séparément conformément à la Directive 2012/19/UE du Parlement européen et du Conseil relative aux déchets d'équipements électriques et électroniques (DEEE).

Ménages utilisateurs d'EEE (consommateurs) dans chaque pays de l'Union européenne: Les équipements électriques et électroniques doivent être mis au rebut conformément aux réglementations nationales de cet État membre relatives à la collecte et à la mise au rebut des EEE.

Utilisateurs professionnels (sociétés - entreprises) au sein de chaque pays de l'Union européenne: Les équipements électriques et électroniques doivent être mis au rebut conformément aux réglementations nationales de l'État membre relatives à la mise au rebut des EEE. Pour plus d'informations, contactez le revendeur ou le fournisseur local.

Utilisateurs privés et professionnels des pays hors Union européenne: Les équipements électriques et électroniques doivent être mis au rebut conformément aux réglementations nationales de l'État membre relatives à la mise au rebut des EEE. La mise au rebut inappropriée des EEE peut avoir un effet néfaste sur l'environnement et sur la santé humaine. En participant à la mise au rebut appropriée de ce produit, vous contribuez à sa réutilisation et à son recyclage tout en protégeant notre environnement.

PORTUGUÊS



O símbolo do contedor com uma cruz sobreposta identifica equipamentos elétricos e eletrónicos (EEE) colocados no mercado após 13 de agosto de 2005, que devem ser recolhidos separadamente de acordo com a Diretiva 2012/19/UE do Parlamento Europeu e do Conselho sobre resíduos de equipamentos elétricos e eletrónicos (WEEE).

Utilizadores de EEE de ambientes domésticos privados (consumidores) dentro de cada país da União Europeia:

Os equipamentos elétricos e eletrónicos deverão ser eliminados em instalações de recolha adequadas, conforme estabelecido pelas autoridades competentes dentro de cada Estado-Membro, ou de acordo com os regulamentos nacionais desse Estado-Membro sobre a recolha e eliminação de WEEE.

Utilizadores profissionais (Companhias - Empresas) dentro de cada país da União Europeia: Os equipamentos elétricos e eletrónicos deverão ser eliminados de acordo com os regulamentos nacionais dos Estados Membros sobre a recolha e eliminação de WEEE. Informações adicionais deverão ser obtidas junto do revendedor ou do fornecedor local.

Utilizadores privados e profissionais dos países fora da União Europeia: Os equipamentos elétricos e eletrónicos deverão ser eliminados de acordo com os regulamentos nacionais dos Estados Membros sobre a recolha e eliminação de WEEE.

A eliminação inadequada de EEE poderá ter um impacto ambiental negativo e afetar a saúde humana, cooperando com a eliminação adequada destes produtos contribui para a reutilização e reciclagem dos mesmos, protegendo simultaneamente o nosso ambiente.

NEDERLANDS



Het symbool van de doorkruiste afvalbak identificeert elektrische en elektronische apparatuur (EEA) op de markt gebracht na 13 augustus 2005, die apart moet worden verzameld in overeenstemming met de Richtlijn 2012/19/UE van het Europees Parlement en de Raad betreffende afgedankte elektrische en elektronische apparatuur (AEEA).

Gebruikers van EEA uit particuliere huishoudens (consumenten) in elk land van de Europese Unie:

Elektrische en elektronische apparatuur moet worden weggegooid via of daarvoor bestemde voorzieningen zoals opgezet door de bevoegde autoriteiten in elke lidstaat met in overeenstemming met de nationale regelgeving van die lidstaat met betrekking tot de inzameling en verwijdering van AEEA.

Professionele gebruikers (Bedrijven - Ondernemingen) in elk land van de Europese Unie: Elektrische en elektronische apparatuur dient te worden vernietigd in overeenstemming met de nationale voorschriften van de lidstaat met betrekking tot de inzameling en verwijdering van AEEA. Nadere informatie moet worden verkregen van de verkoper of lokale leverancier.

Zowel particuliere als professionele gebruikers uit landen buiten de Europese Unie: Elektrische en elektronische apparatuur dient te worden vernietigd in overeenstemming met de nationale voorschriften van de lidstaat met betrekking tot de inzameling en verwijdering van AEEA. Onjuiste verwijdering van EEA kan een negatieve invloed op het milieu hebben en de menselijke gezondheid schaden. Samenwerking bij de correcte verwijdering van dit product draagt bij aan hergebruik en recycling en beschermt ons milieu.

SVENSKA



Symbolen med en överkryssad sopkåpa på hjul identifierar elektrisk och elektronisk utrustning (EEE), som lanserats på marknaden efter 13 augusti 2005 som ska samlas in separat i enlighet med Europaparlamentets och rådets direktiv 2012/19/EU om avfall som utgörs av eller innehåller elektriska eller elektroniska produkter (WEEE).

Användare av EEE i privatkvarnen (konsumenter) i varje land inom Europeiska unionen:

Elektrisk och elektronisk utrustning ska bortskaffas på lämpliga uppsamlingsanläggningar som inrättats av behöriga myndigheter i varje medlemsstat eller i enlighet med den medlemsstatens nationella bestämmelser gällande uppsamling och bortskaffande av WEEE.

Yrkesmässiga användare (bolag – företag) i varje land inom Europeiska unionen: Elektrisk och elektronisk utrustning ska bortskaffas i enlighet med medlemsstatens nationella bestämmelser gällande uppsamling och bortskaffande av WEEE. Ytterligare information ska erhållas från återförsäljaren eller den lokala säljaren.

Både privata och yrkesmässiga användare från länder utanför Europeiska unionen: Elektrisk och elektronisk utrustning ska bortskaffas i enlighet med medlemsstatens nationella bestämmelser gällande uppsamling och bortskaffande av WEEE. Otillräpplig uppsamling av EEE kan ha en negativ miljöpåverkan och skada människors hälsa i och med att du samarbetar. Våga om att bortskaffa den här produkten på ett lämpligt sätt, bidra till att produkten kan återanvändas och återvinnas, samtidigt som du hjälper till att skydda miljön.

DANSK



Symbolet med den overstregede affaldspos på hjul angiver, at elektrisk og elektronisk udstyr (EEE), der er markedsført efter d. 13. august 2005, skal indsamles særskilt i henhold til Europa-Parlamentets og Rådets direktiv 2012/19/UE om affald af elektrisk og elektronisk udstyr (WEEE).

Brugere af EEE fra private husholdninger (forbrugere) inden for hvert EU-medlemsland: Elektrisk og elektronisk udstyr skal bortskaffes via passende indsamlingsfaciliteter, der er etableret af de ansvarlige myndigheder i hver medlemsstat, eller i henhold til den pågældende medlemsstats nationale lovgivning vedrørende indsamling og bortskaffelse af WEEE.

Professionelle brugere (virksomheder – firmaer) inden for hvert EU-medlemsland: Elektrisk og elektronisk udstyr skal bortskaffes i henhold til den pågældende medlemsstats nationale lovgivning vedrørende indsamling og bortskaffelse af WEEE. Yderligere oplysninger kan rekvireres fra forhandleren eller den lokale leverandør.

Både private og professionelle brugere fra lande uden for den Europæiske Union: Elektrisk og elektronisk udstyr skal bortskaffes i henhold til den pågældende medlemsstats nationale lovgivning vedrørende indsamling og bortskaffelse af WEEE.

Uheldig opsamlings bortskaffelse af EEE kan have en negativ virkning på miljøet og på folks helbreds. Samarbejd i forbindelse med korrekt bortskaffelse af disse produkter bidrager til at beskytte miljøet, samtidig med at du hjælper til at skynde miljøet.

SUOMI



Merkki, jossa on yli rastiin pyyhäläinen jätteenä, viittaa 13.8.2005 jälkeen markkinoille tuotuihin sähkö- ja elektroniikkalaitteisiin, jotka Euroopan parlamentin ja neuvoston sähkö- ja elektroniikkalaiteromusta annetun direktiivin 2012/19/UE (WEEE) mukaisesti on kerättävä erikseen.

Yksityisten kotitalouksien sähkö- ja elektroniikkalaitteiden (kuluttajat) kussakin Euroopan unionin maassa: Sähkö- ja elektroniikkalaitteet on hävitettävä kunkin jäsenvaltion toimivaltuisten viranomaisien järjestämien keräyspisteiden kautta tai kyseisen jäsenvaltion kansallisten sähkö- ja elektroniikkalaiteromun keräystä ja hävittämistä koskevien määräysten mukaisesti.

Yksityisten kotitalouksien sähkö- ja elektroniikkalaitteiden (kuluttajat) kussakin Euroopan unionin maassa: Sähkö- ja elektroniikkalaitteet on hävitettävä jäsenvaltion kansallisten sähkö- ja elektroniikkalaiteromun keräystä ja hävittämistä koskevien määräysten mukaisesti. Lisätietoja on voitava saada jälleenyksityisiltä paikalliselta toimittajalta.

Euroopan unionin ulkopuolisten maiden yksityiset ja ammattikäyttäjät: Sähkö- ja elektroniikkalaitteet on hävitettävä jäsenvaltion kansallisten sähkö- ja elektroniikkalaiteromun keräystä ja hävittämistä koskevien määräysten mukaisesti.

Sähkö- ja elektroniikkalaitteiden epäasianmukaisella hävittämisellä on kielteisiä vaikutuksia ympäristöön ja ihmisten terveyteen. Yhteistyö tuoten tuottajan kanssa, hävittäminen edistää tuotteen uudelleenkäyttöä ja kierrätystä ja suojelee ympäristöämme.



For more information
please contact
your local FIMER
representative or visit:

fimer.com

We reserve the right to make technical changes or modify the contents of this document without prior notice. With regard to purchase orders, the agreed particulars shall prevail. FIMER does not accept any responsibility whatsoever for potential errors or possible lack of information in this document.

We reserve all rights in this document and in the subject matter and illustrations contained therein. Any reproduction, disclosure to third parties or utilization of its contents – in whole or in parts – is forbidden without prior written consent of FIMER. Copyright© 2020 FIMER. All rights reserved.